

Effect of Electric Field Amplitude on Electrical Fatigue Behavior of Lead Zirconate Titanate Ceramic

S. Kamposiri, S. Pojprapai, R. Yimnirunand, and B. Marungsri

Abstract—Fatigue behaviors of Lead Zirconate Titanate (PZT) ceramics under different amplitude of bipolar electrical loads have been investigated. Fatigue behavior is represented by the change of hysteresis loops and remnant polarization. Three levels of electrical load amplitudes (1.00, 1.25 and 1.50 kV/mm) were applied in this experimental. It was found that the remnant polarization decreased significantly with the number of loading cycles. The degree of fatigue degradation depends on the amplitude of electric field. The higher amplitude exhibits the greater fatigue degradation.

Keywords—Lead Zirconate Titanate (PZT), hysteresis loop, Sawyer-Tower circuit, fatigue, polarization.

I. INTRODUCTION

FERROELECTRIC material has been used for widely different types of industrial electronics; for example, capacitor, and thermistor used for temperature control in car, sensor and actuator used in the manufacture of electronic devices which require high resolution, and transducer used to detect fish in the sea etc [1]. The main materials for these devices are ferroelectric ceramics with good piezoelectric properties. For instance, Lead Zirconate Titanate (PZT) that can convert mechanical energy into electrical energy (direct piezoelectric effect) and electrical energy into mechanical energy (converse piezoelectric effect). The performances of these electronic equipments are up to the performance of piezoelectric ceramic materials. In practice, PZT will take electrical or mechanical loads for many cycles (cyclic loads) which bring it to the fatigue from changing the polarity. In the event of an electrical load, this is called the electrical fatigue or polarization fatigue. The electrical fatigue endurance is important to performance and lifetime of the ferroelectric material.

A. Polarization

Basically, the dielectric material molecule composed of atoms that are held together by ionic bonds, when feed the electric field for these materials. The positive and negative ions in the unit cell separated from each other called

polarization. For PZT ceramic, polarization in unit cell of crystal structure can arrange in the direction of the external electric field polarity. As illustrated in Fig. 1, the ability to arrange of polarization under an electric field is a parameter that indicates the conditions ferroelectric. If the ability to arrange of polarization due to an external electric field is reduced, ferroelectric materials will result in deterioration. Reduction of polarization indicates that PZT ceramic unable to show the properties of piezoelectric. Generally, the ability to arrange of polarization may be indicating by the nature of hysteresis loop.

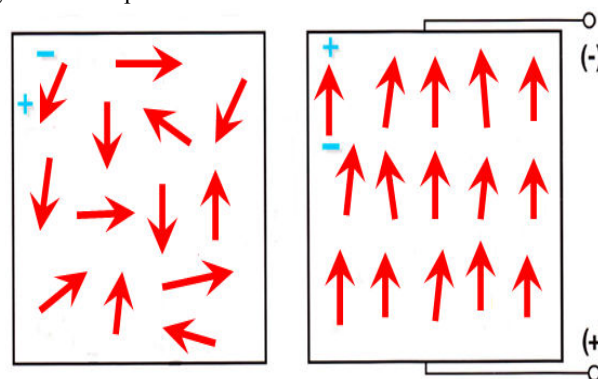

Fig. 1 Polarization direction by the electric field

B. Hysteresis Loop

In case of ferromagnetic material, hysteresis loop shows the relationship between magnetization loop and magnetic field. For ferroelectric ceramic, hysteresis loop shows the relationship between the polarization and electric field, as illustrated in Fig 2. The most important characteristic of ferroelectric materials is polarization reversal (or switching) by an electric field. The emergence of the hysteresis loop can be described as follows; when an alternating electric field is low, polarization will be linear increasing by size of field (range A-B). And when the electric field increases with the polarization direction, it will start reversing the electric field (range B-C) the polarization response in this range is very non-linear (range D-C). And when all polarization arranges to new direction (point C), when reduced an electric field some polarization will returns to the same direction but electric field position is zero (point E) polarization is not zero. So, if give the polarization run out the electric field must be reversing (point F). And when electric field increased to the opposite direction, the new polarization will arranged to new direction before point (point G). Later, when reversing the field again, it

S. Kamposiria master degree student with Suranaree University of Technology, Nakhon Ratchasima, 30000, Thailand.

S. Pojprapai is with Suranaree University of Technology, Nakhon Ratchasima, 30000, Thailand.

R. Yimnirun is with Suranaree University of Technology, Nakhon Ratchasima, 30000, Thailand.

B. Marungsri is with Suranaree University of Technology, Nakhon Ratchasima, 30000, Thailand (corresponding author, phone: +66 44224366; fax: +66 4422 4601; e-mail: bmsvhee@sut.ac.th).

is the complete of the trial. The polarization when electric field is zero (point E) is called the remanent polarization, P_r . The electric field is used to reduce the polarization to return to the zero is called coercive field, E_c .

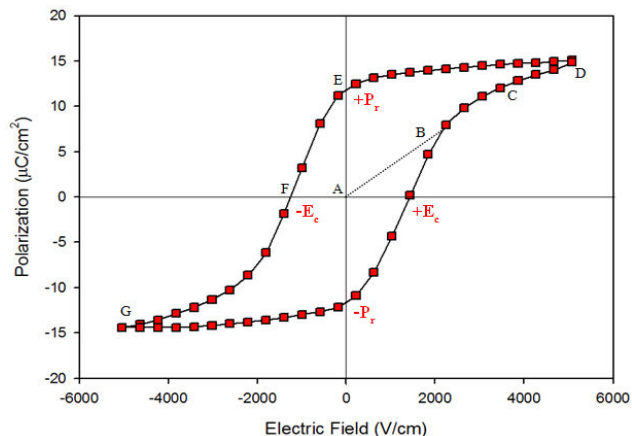

Fig. 2 Sample hysteresis loop of BaTiO₃ material

C. Ferroelectric Fatigue

In the study, ferroelectric fatigue can be found from hysteresis loop. When a fatigue occurs, the size of the hysteresis loop and the remanent polarization will be reduced when increase cycle of electrical field, as illustrated in Fig. 3. intensity of different fatigue caused by other variables such as electric field, frequency and temperature [2-6]. However, the trial was limited by the frequency parameter and constant temperature while changing the size of the electric field.

This research demonstrates the influence of the electric field on the fatigue behavior of the electrical polarity of the ferroelectric material, material, which tested by electrical fatigue test machine.

II. TEST METHOD

Un-polling PZT ceramic manufactured by Thales Underwater Systems (Australia) Company was used as test specimen in this study. Then, PZT ceramic was cut to disc shape with 10 mm's diameter and 1 mm's thick. Before the experimental, two silver plates were attached to two sides of specimen before polling. For polling, electric field 1.7 kV/mm was applied to specimen for 30 min. at 120°C.

Hysteresis loop of PZT ceramic material was measured by using Sawyer-Tower circuit [7], as shown in Fig. 4(a) and Fig. 4(b).

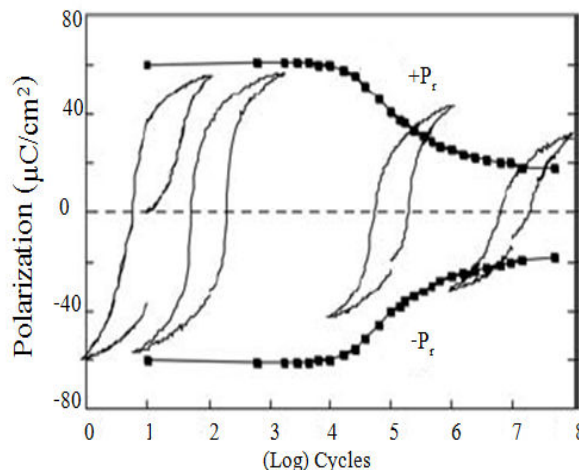
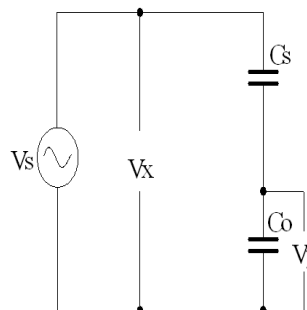
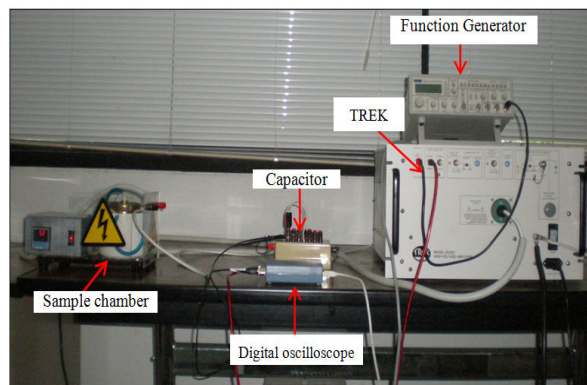

Fig. 3 Sample fatigue in PZT ceramic [8]



(a) Sawyer-Tower circuit diagram ($C_0 = 1\mu\text{F}$, $C_s = \text{sample}$; $C_0 \gg C_s$)



(b) Sawyer-Tower circuit layout

Fig. 4 Experimental setup for this study

As illustrated in Fig. 4(a), V_x is horizontal input signal and V_y is vertical input signal to oscilloscope. As seen from Sawyer-Tower diagram, horizontal axis of hysteresis loop on screen instead of the voltage drop across supply and vertical axis instead of voltage across capacitor (C_0) which varied with the electric charge that occurs on the ceramic PZT (C_s) by that the polarization function is the number of charge per area unit. That can be written as the following equation.

$$P_{\text{sample}} = Q_s/A \quad (1)$$

where:

P_{sample} is the polarization of PZT ceramic.
 Q_s is the cumulative of PZT ceramic charge.
 A is the cross-sectional area of PZT ceramic.
 Similarly, the polarization can be written

$$P_{\text{sample}} = C_0 V_y / A \quad (2)$$

where:

C_0 is the standard capacity of the capacitor.
 V_y is voltage drop across a standard capacitor.

The electric field at the input to the PZT ceramic can be written as follows

$$E = V_x / d \quad (3)$$

where:

E is the electric field at input to PZT ceramic.
 V_x is the supply voltage drop.
 d is the thickness of PZT ceramic.

For study of fatigue from changing polarity of the PZT ceramic, specimen was placed between the electrode tip - flat plane, as shown in Fig. 5. During test, specimen was immersed in silicone oil to prevent surface discharge.

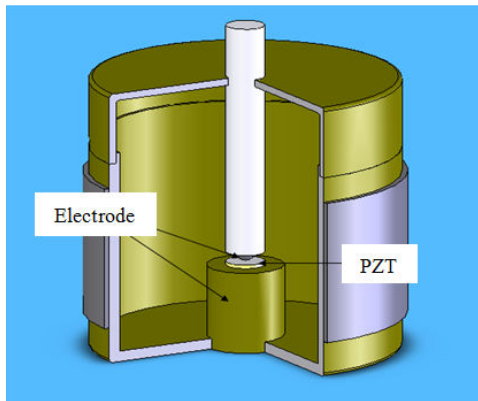

Fig. 5 Testing chamber

The testing process can be written as follows.

- Installing specimen in testing chamber.
- Applying the electric field with frequency 10 Hz to specimen in testing chamber at room temperature. Three levels of the electric field (1, 1.25 and 1.50 kV/mm.) were used.
- In each test, the cycles of applying electric field are 1×10^3 , 5×10^3 , 1×10^4 , 5×10^4 , 1×10^5 , 5×10^5 and 1×10^6 cycles, respectively.
- Recording the hysteresis loop.
- Calculating the electric field and polarization on each of the test.

III. TEST RESULTS AND DISCUSSIONS

The effects of electric field to fatigue from changing in polarization of PZT material have been studied.

From the experimental results, hysteresis loops of each electrical load having same frequency and cycle are illustrated in Fig. 6, Fig. 7 and Fig. 8, respectively. As seen from the

results, size of hysteresis loop depends on magnitude and cycle of electric field stress. Furthermore, size of hysteresis loop decreases with increasing in electric load cycle. As seen in Fig. 6, Fig. 7 and Fig. 8, rapidly decrease of hysteresis loop can be seen after 5×10^4 cycles. However, slowly decrease of hysteresis loop can be seen after 5×10^5 .

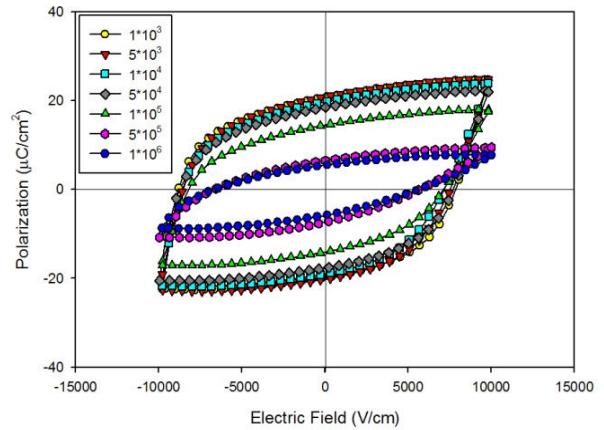

Fig. 6 Hysteresis loop with difference cycles (Electric field stress 1kV/mm)

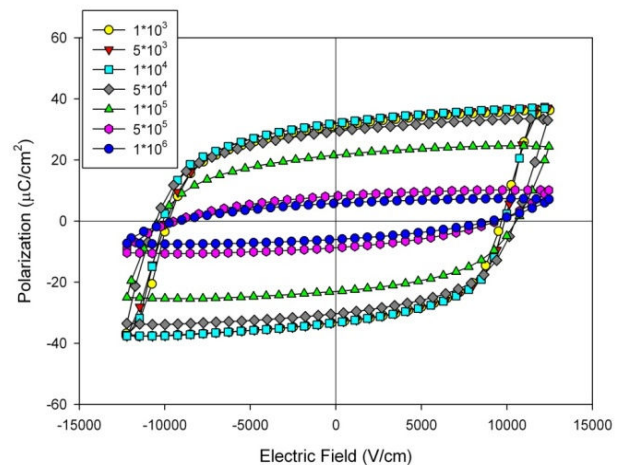

Fig. 7 Hysteresis loop with difference cycles. (Electric field stress 1.25 kV/mm)

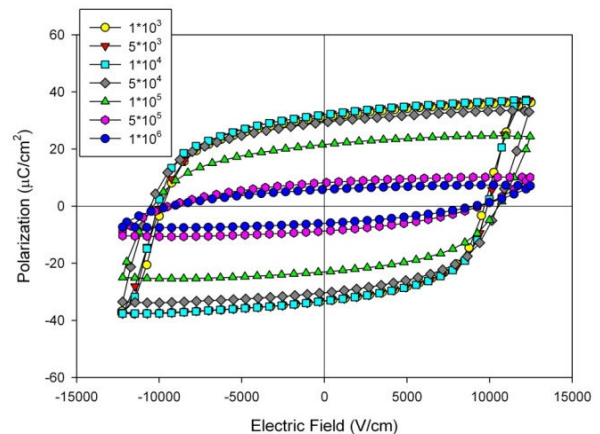

Fig. 8 Hysteresis loop with difference cycles (Electric field stress 1kV/mm)

As shown in Fig. 9 and 10, the remnant polarization and coercive field which are derived from the hysteresis loop. As seen in Fig. 9, larger reduction in remnant polarization at 1.25 and 1.5 kV/mm can be seen when increasing electric stress cycles. In case of electric field 1.5 kV/mm, reduction in remnant polarizations 81.76 %. While reduction in remnant polarization of electric field 1 and 1.25 kV/m are 69.85 and 78.91 %, respectively. As seen from the results, at the beginning, the remnant polarization of the electric field 1.5 kV/mm is more than the other two electric field stresses (1 and 1.25 kV/mm). However, faster reduction in remnant polarization at the electric field 1.5 kV/mm can be seen when comparing with the other two electric field stresses. In case of coercive field, as shown in Fig. 10, slightly increasing can be seen from the beginning but decreasing when increasing electric field stress cycle.

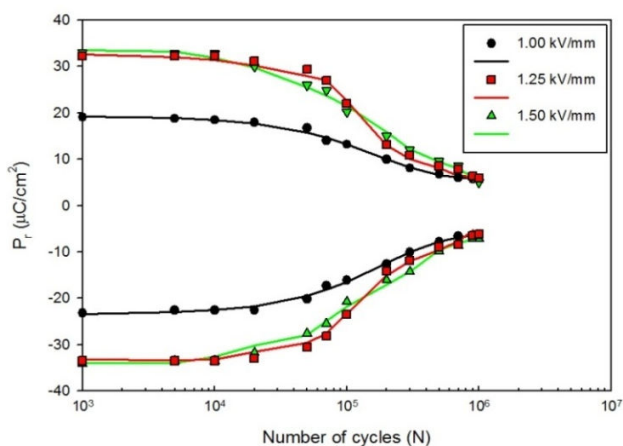

Fig. 9 Remnant polarization under different electrical field (Solid lines are the values obtained from experimental and dots are obtained from equation 4)

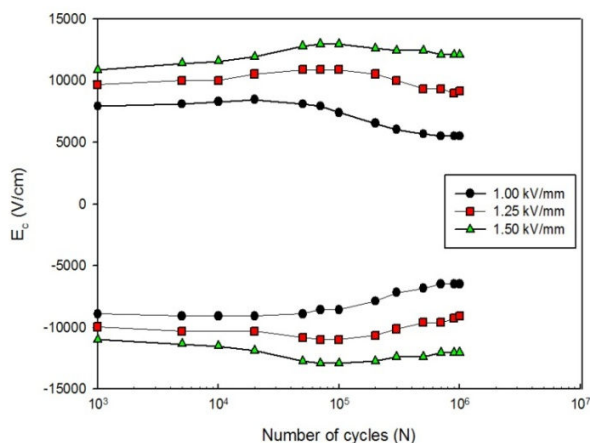

Fig. 10 Coercive field under difference electric field

This may be due in the first domain that can move as well when an electric field is increased. When numbers of cycles are increased, some domains unmovable because it was pinned by charged defects or oxygen vacancy [9-10]. This phenomenon is called domain pinning effect. Resulted polarization or domain in the PZT material unable to changed direction as the same direction of the electric field and the

domain wall can't move well. So, the remanent polarization is reduced.

As shown in Fig. 11, the model reduced the number of domains that can reverse direction as the electric field. The first is that during period 1×10^4 to 5×10^4 domain still moving well because a result of fixation of the domain walls is minimal. When number of cycles increased to the range 5×10^4 to 2×10^5 some domains unmovable, resulting in the remnant polarization decreased rapidly. The coercive field values which reflect the energy which system use to reversing direction of the domain are more valuable. But when it comes to the other one is cycle 2×10^5 to 1×10^6 , the reduction of the remanent polarization is reduced slowly and almost constant because the reversing domain's value is reduced. From the model in Fig. 11, increasing rate of the pinned domain has gone down. This could result in the coercive field is slowly reduced and almost constant too.

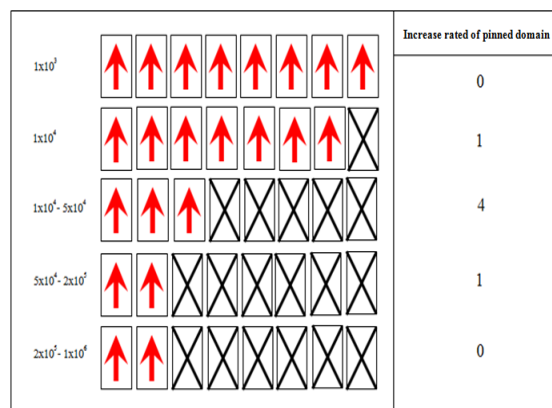

Fig. 11 Model of proportion domains that reversible direction (replaced by X) and irreversible domain effected of pinned domain (replaced by red arrow)

The reduction of the remnant polarization is based on the form of logarithmic fatigue. It can be written as the following equation.

$$P_N = P_o - A \ln(N+B) \quad (4)$$

where

A, B is constant value

P_o is the initial polarization.

N is the electric field's cycle.

The parameters A and B, at electric field values can be displayed in Table I. This study suggests that at electric field 1.50 kV / mm, the remnant polarization is rapidly decreased compared to the electric field 1 and 1.25 kV / mm. Resulting fatigue from a change in polarity is increased. Number of domains that can reverse direction can be decreased resulting in value of remanent polarization is reduced.

TABLE I
 REDUCTION OF THE REMNANT POLARIZATION PARAMETER AT THE DIFFERENT
 ELECTRIC FIELD

Electric Field (kV/mm)	P_0	A	B
1.00	59.707	-79.219	3.96 -5.34 23635.3 30863.46
1.25	100.4	-98	6.81 -6.8 13921.48 10614.19
1.50	110.08	-110.136	7.57 -7.56 20381.16 18516.50

IV. CONCLUSION

Effects of electric field amplitude on electrical fatigue behavior of PZT Ceramic have been studied. The following conclusions are given.

(1) Larger reduction in remnant polarization can be seen in case of electric field stress 1.5 kV/mm when comparing with the other two electric field stresses (1 and 1.25 kV/mm). This may be due to the electric field is increased a result of the pinned domain wall will be more valuable as well. Number of domains that can reverse direction will be greatly reduced; resulting in the remanent polarization is reduced rapidly.

(2) The degree of fatigue degradation depends on the amplitude of electric field.

(3) The higher amplitude exhibits the greater fatigue degradation.

ACKNOWLEDGMENT

The authors would like to thank Suranaree University of for kind financial support.

REFERENCES

- [1] G. H. Haertling, "Ferroelectric ceramics history and technology", *Journal of the American Ceramic Society*, Vol.82, 1999, pp. 797 - 818.
- [2] R. Qian, S. Lukasiewicz and Q. Gao, "Electrical fatigue response for ferroelectric ceramic under electrical cyclic load", *Solid-State Electronics*, Vol.44, 2000, pp. 1717-1722.
- [3] X. J. Lou and J. Wang, "Bipolar and unipolar electrical fatigue in ferroelectric lead zirconatetitanate thin films: An experimental comparison study", *Physical Review*, Vol.24, 2010, pp. 104-108.
- [4] N. Balke, H. Kungl, T. Granzow and D. C. Lupascu, "Bipolar fatigue caused by field screening in Pb(Zr,Ti)O₃ ceramics", *Journal of the American Ceramic Society*, Vol. 90, No. 12, 2007, pp. 3869-3874.
- [5] Y. Wang, K. H. Wong and C. L. Choy, "Fatigue problems in ferroelectric thin films", *Physical Review*, Vol. 191, No. 2, 2002, pp. 482-488.
- [6] S. Pojprapai, J. Russell, J. E. Daniels, M. Hoffman, "Frequency effects on fatigue crack growth and growth-tip domain switching behavior in a lead zirconatetitanate ceramic", *Acta Materialia*, Vol. 54, No. 11, 2007; pp. 3075-3083.
- [7] C. B. Sawyer and C. H. Tower, "Rochelle salt as a dielectric", *Physical Review*, Vol. 35, 1930, pp. 269 - 273.
- [8] D. Damjanovic, "Ferroelectric dielectric and piezoelectric properties of ferroelectric thin films", *Reports on Progress in Physics*, Vol. 61, 1998, pp. 1267.
- [9] C. Brennan, "Model of ferroelectric fatigue due to defect/domain interaction", *Department of chemistry*, Vol.150, 1998, pp. 199-208.
- [10] C. H. Park and D. J. Chadi, "Microscopic study of oxygen-vacancy defect in ferroelectric perovskites", *Physical Review*, Vol. 57, No. 22, 1997, pp. 13961-13964.