

Mathematical Model for the Transmission of Leptospirosis in Juvenile and Adults Humans

P. Pongsumpun

Abstract—Leptospirosis occurs worldwide (except the poles of the earth), urban and rural areas, developed and developing countries, especially in Thailand. It can be transmitted to the human by rats through direct and indirect ways. Human can be infected by either touching the infected rats or contacting with water, soil containing urine from the infected rats through skin, eyes and nose. The data of the people who are infected with this disease indicates that most of the patients are adults. The transmission of this disease is studied through mathematical model. The population is separated into human and rat. The human is divided into two classes, namely juvenile and adult. The model equation is constructed for each class. The standard dynamical modeling method is then used for analyzing the behaviours of solutions. In addition, the conditions of the parameters for the disease free and endemic states are obtained. Numerical solutions are shown to support the theoretical predictions. The results of this study guide the way to decrease the disease outbreak.

Keywords—Adult human, juvenile human, leptospirosis, mathematical model.

I. INTRODUCTION

LEPTOSPIROSIS is an infectious disease caused by a type of bacteria called a spirochete. This disease is transmitted by many animals such as rats, skunks, opossums, raccoons, foxes, and other vermin. It is transferred through contacting with infected soil or water. The soil or water is contaminated with the waste products of an infected animal. People contract the disease by either ingesting contaminated food or water or by broken skin and mucous membrane (eyes, nose, sinuses, mouth) contact with the contaminated water or soil. Leptospirosis occurs around the world, but it is usually found in the tropical countries. There are 7 strains due to Leptospirosis, such as *Leptospira interrogans*, *Leptospira kirschneri*, *Leptospira noguchii*, *Leptospira borgpetersenii*, *Leptospira santarosai*, *Leptospira weilii* and *Leptospira inadai*. Leptospirosis has emerged in Thailand since 1997, as a major health concern [1,2]. The characteristics of the patients due to Leptospirosis are high fever, headache, chills, muscle aches, conjunctivitis (red eyes), diarrhea, vomiting, and kidney or liver problems (which may include jaundice), anemia and, sometimes, rash. The duration of symptoms due to this disease may last from a few days to several weeks. After infected, some patients can be mild and without obvious symptom [3]-[7]. The season and the environmental factors effect to the

P. Pongsumpun is with the Department of Mathematics, Faculty of Science, King Mongkut's Institute of Technology Ladkrabang, Chalokkrung road, Ladkrabang, Bangkok, Thailand, 10520(phone: (662)-329-8400 ext.320; fax: (662)-329-8400 ext.284; e-mail: kppuntan@kmitl.ac.th).

outbreaks of this disease [8]. A deterministic model (consists of a set of differential equations) have a long tradition in the study of infectious diseases. In 2006, J.Holt and et al. constructed a mathematical model for the transmission of Leptospirosis in Tanzania [9]. In 2007, W.Triampo and et al. considered a deterministic SIR (S = Susceptible, I = Infected, R = Recovered) model for the transmission of leptospirosis in the Thai population but they did not consider the age group of the patients [10]. SIR model can be used for describing the transmission of many infectious diseases [11]. From the data of Leptospirosis patients during 2002 and 2009 in Thailand [12], we can see that there is the different number of cases between juvenile and adults humans as shown in Fig. 1.

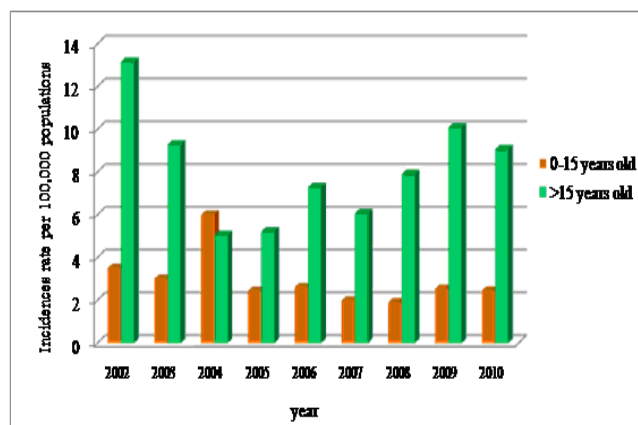

Fig. 1 Reported cases of Leptospirosis in Thailand, year 2002-2010 [12]

In this paper, we consider the transmission of Leptospirosis in Thailand through mathematical modeling. The difference of transmission rate for this disease between juvenile and adult humans is considered. The basic reproductive number of this disease is analyzed. The alternative way for controlling the outbreak of this disease is introduced.

II. MATHEMATICAL MODEL

We formulate the mathematical model of this disease by considering the dynamical equations for human and rats. The human is separated into two groups; juvenile and adult groups. Each group is divided into three sub-groups such as Susceptible(S), Infectious (I) and Recovered(R). The rat is divided into two sub-groups such as Susceptible(S) and Infectious (I) because the rat never recovers from infection. We assume that total human and rat populations are constant [13]. For our dynamical equations, the definitions of variables and parameters are given as follows:
b is the birth rate of human population,

d is the death rate of human population,
 N_t is the total human population,
 N_J is the total juvenile human population,
 N_A is the total adult human population,
 N_R is the total rat population,
 δ is the transition rate from juvenile to adult humans,
 s is the recovery rate of human,
 I_R is the birth rate of rat population,
 μ_R is the death rate of rat population,
 θ_J is the transmission rate of Leptospirosis from rat to juvenile human populations,
 θ_A is the transmission rate of Leptospirosis from rat to adult human populations,
 θ_R is the transmission rate of Leptospirosis between rat populations,
 \tilde{S}_J is the number of susceptible juvenile human populations,
 \tilde{I}_J is the number of infectious juvenile human populations,
 \tilde{R}_J is the number of recovered juvenile human populations,
 \tilde{S}_A is the number of susceptible adult human populations,
 \tilde{I}_A is the number of infectious adult human populations,
 \tilde{R}_A is the number of recovered adult human populations,
 The transmission diagrams for Leptospirosis of human and rat populations are represented in figure 2 and figure 3, respectively.

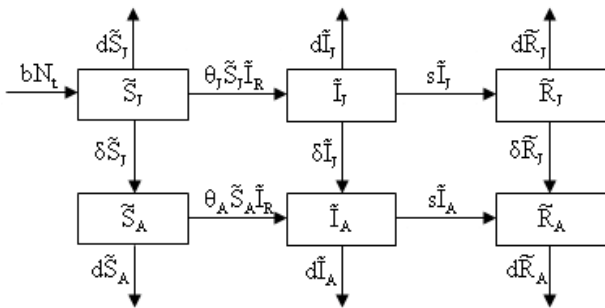

Fig. 2 The transmission diagram for human population

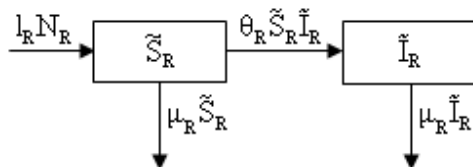

Fig. 3 The transmission diagram for rat population

The dynamical equations for human and rat populations are given as follows:

$$\frac{d\tilde{S}_J}{dt} = bN_t - \theta_J \tilde{S}_J \tilde{I}_J - (\delta + d)\tilde{S}_J \quad (1)$$

$$\frac{d\tilde{I}_J}{dt} = \theta_J \tilde{S}_J \tilde{I}_J - (s + \delta + d)\tilde{I}_J \quad (2)$$

$$\frac{d\tilde{R}_J}{dt} = s\tilde{I}_J - (\delta + d)\tilde{R}_J \quad (3)$$

$$\frac{d\tilde{S}_A}{dt} = \delta \tilde{S}_J - \theta_A \tilde{S}_J \tilde{I}_R - d\tilde{S}_A \quad (4)$$

$$\frac{d\tilde{I}_A}{dt} = \theta_A \tilde{S}_A \tilde{I}_A - (s + \delta + d)\tilde{I}_A \quad (5)$$

$$\frac{d\tilde{R}_A}{dt} = s\tilde{I}_A - (\delta + d)\tilde{R}_A \quad (6)$$

$$\frac{d\tilde{S}_R}{dt} = I_R N_R - \theta_R \tilde{S}_R \tilde{I}_R - \mu_R \tilde{S}_R \quad (7)$$

$$\frac{d\tilde{I}_R}{dt} = \theta_R \tilde{S}_R \tilde{I}_R - \mu_R \tilde{I}_R \quad (8)$$

where $N_t = N_J + N_A$, $N_J = \tilde{S}_J + \tilde{I}_J + \tilde{R}_J$,
 $N_A = \tilde{S}_A + \tilde{I}_A + \tilde{R}_A$ and $N_R = \tilde{S}_R + \tilde{I}_R$. (9)

The total human and rat populations are supposed to be constant. So the dynamical change of each populations equals to 0. Setting $\frac{dN_t}{dt} = \frac{dN_J}{dt} = \frac{dN_A}{dt} = \frac{dN_R}{dt} = 0$, then $b = d$,

$$\frac{N_t}{N_J} = \frac{b + \delta}{b}, \frac{N_A}{N_J} = \frac{\delta}{b} \text{ and } I_R = \mu_R. \text{ We normalize our}$$

dynamical equations by setting

$$S_J = \tilde{S}_J/N_J, I_J = \tilde{I}_J/N_J, R_J = \tilde{R}_J/N_J, S_A = \tilde{S}_A/N_A,$$

$$I_A = \tilde{I}_A/N_A, R_A = \tilde{R}_A/N_A, S_R = \tilde{S}_R/N_R \text{ and } I_R = \tilde{I}_R/N_R,$$

then the reduced equations become

$$\frac{dS_J}{dt} = (d + \delta)(1 - S_J) - \theta_J S_J I_R N_R \quad (10)$$

$$\frac{dI_J}{dt} = \theta_J S_J I_R N_R - (d + \delta + s)I_J \quad (11)$$

$$\frac{dS_A}{dt} = d(1 - S_A) - \theta_A S_A I_R N_R \quad (12)$$

$$\frac{dI_A}{dt} = \theta_A S_A I_R N_R + dI_J - (s + d)I_A \quad (13)$$

$$\frac{dI_R}{dt} = (\theta_R N_R - \mu_R)I_R - \theta_R N_R I_R^2 \quad (14)$$

with the conditions $R_J = 1 - S_J - I_J, R_A = 1 - S_A - I_A,$

$$S_R = 1 - I_R.$$

III. ANALYSIS OF MODEL

A. Model

To find the equilibrium states, we set the right hand side of equations (10) to (14) equal to zero. So the equilibrium states are

i) disease free state: $E_1 = (1,0,1,0,0)$ (15)

ii) endemic disease state: $E_2 = (S_J^*, I_J^*, S_A^*, I_A^*, I_R^*)$ (16)

where

$$S_J^* = \frac{1}{1 + \eta_1 I_R^*}, I_J^* = \frac{\eta_1 I_R^*}{(1 + \eta_2)(1 + \eta_1 I_R^*)}, S_A^* = \frac{1}{1 + \eta_3 I_R^*},$$

$$I_A^* = I_R^* \left(\frac{\eta_4}{1 + \eta_3 I_R^*} + \frac{\eta_5}{1 + \eta_1 I_R^*} \right), I_R^* = 1 - \frac{\mu_R}{\theta_R N_R},$$

$$\eta_1 = \frac{\theta_J N_R}{d + \delta}, \eta_2 = \frac{s}{d + \delta}, \eta_3 = \frac{\theta_A N_R}{d}, \eta_4 = \frac{\theta_A N_R}{d + s} \text{ and}$$

$$\eta_5 = \frac{d \eta_1}{(d + s)(1 + \eta_2)}.$$

The locally asymptotical stable of each equilibrium state is determined by the sign of eigenvalues for each equilibrium state. If all eigenvalues have negative real parts, then that equilibrium state is local stability [13]. The eigenvalues are obtained by solving the following characteristic equation

$$\det(J_{C_1} - \lambda I_5) = 0 \quad (17)$$

where I_5 is the identity matrix dimension 5×5 and J_{C_1} is the *Jacobian* matrix of the steady state $D_i; i=1,2$. For the disease free state $C_1 = (1,0,1,0,0)$, the *Jacobian* matrix is given by

$$J_{C_1} = \begin{pmatrix} -(d+\delta) & 0 & 0 & 0 & -\theta_J N_R \\ 0 & -(d+\delta+s) & 0 & 0 & \theta_J N_R \\ 0 & 0 & -d & 0 & -\theta_A N_R \\ 0 & d & 0 & -(d+r) & \theta_A N_R \\ 0 & 0 & 0 & 0 & -(d-\theta_R N_R) \end{pmatrix}$$

The characteristic equation is

$$(\lambda + d + \delta)(\lambda + d + \delta + s)(\lambda + d)(\lambda + d + s)(\lambda + \mu_R - \theta_R N_R) = 0 \quad (18)$$

The eigenvalues are

$$\lambda_1 = -d - \delta, \lambda_2 = -d - \delta - s, \lambda_3 = -d, \lambda_4 = -d - s, \lambda_5 = -\mu_R + \theta_R N_R. \quad (19)$$

We can see that all eigenvalues have negative real parts for

$$G_0 < 1; \text{ where } G_0 = \frac{\theta_R N_R}{\mu_R}. \quad (20)$$

In the same manner, for the endemic disease state

$C_2 = (S_J^*, I_J^*, S_A^*, I_A^*, I_R^*)$, the *Jacobian* matrix is given by

$$J_{C_2} = \begin{pmatrix} -(d+\delta)\theta_J N_R I_R^* & 0 & 0 & 0 & -\theta_J N_R S_J^* \\ \theta_J N_R I_R^* & -(d+\delta+s) & 0 & 0 & \theta_J N_R S_J^* \\ 0 & 0 & -d\theta_A N_R I_R^* & 0 & -\theta_A N_R S_A^* \\ 0 & d & \theta_A N_R I_R^* & -(d+r) & \theta_A N_R S_A^* \\ 0 & 0 & 0 & 0 & -\mu_R + \theta_R N_R (1 - 2I_R^*) \end{pmatrix}$$

the characteristic equation is given by

$$(\lambda + d + \delta + \theta_J N_R - \frac{\mu_R \theta_J}{\theta_R})(\lambda + d + \delta + s)(\lambda + d + s)(\lambda + d + \theta_A N_R - \frac{\mu_R \theta_A}{\theta_R})(\lambda + \theta_R N_R - \mu_R) = 0. \quad (21)$$

The eigenvalues are

$$\lambda_1 = -d - \delta - \theta_J N_R + \frac{\mu_R \theta_J}{\theta_R}, \lambda_2 = -d - \delta - s, \lambda_3 = -d - s, \lambda_4 = -d - \theta_A N_R + \frac{\mu_R \theta_A}{\theta_R}, \lambda_5 = -\theta_R N_R + \mu_R \quad (22)$$

The above eigenvalues have negative real parts for $G_0 > 1$;

$$\text{where } G_0 = \frac{\theta_R N_R}{\mu_R}. \quad (23)$$

Therefore, we can conclude that the disease free state is locally asymptotical stable for $G_0 < 1$ and the endemic disease state is locally asymptotical stable for $G_0 > 1$, where

$$G_0 = \frac{\theta_R N_R}{\mu_R}. \text{ The basic reproductive number of the disease is}$$

evaluated from the averaging of the number of secondary case that one case can produce if he/she is introduced into a susceptible human. This number is represented as $G_0' = \sqrt{G_0}$.

B. Numerical Simulation

In this paper, we are interested in the transmission of Leptospirosis between the human and rat populations. The different transmission rate of Leptospirosis to juvenile and adult humans is considered. The values of the parameters used in this study are as follows: $d = 1/(365 \times 70)$ per day corresponds to the life expectancy of 70 years for human population. $s = 1/15$ per day corresponds to the 15 days of the recovery for the human populations. $\delta = 1/(365 \times 15)$ per day satisfies the 15 years of the transition from juvenile to adult human populations. $\mu_R = 1/(365 \times 1.5)$ per day satisfies the life expectancy of 1.5 years for rat population. The other parameters are arbitrary chosen as follows: the total juvenile, adult humans, transmission rate of Leptospirosis from rat to juvenile humans, transmission rate of Leptospirosis from rat to adult humans, transmission rate of Leptospirosis between rats are $N_J = 3,000$, $N_A = 7,000$, $\theta_J = 0.001$, $\theta_A = 0.01$ and $\theta_R = 0.000001$, respectively.

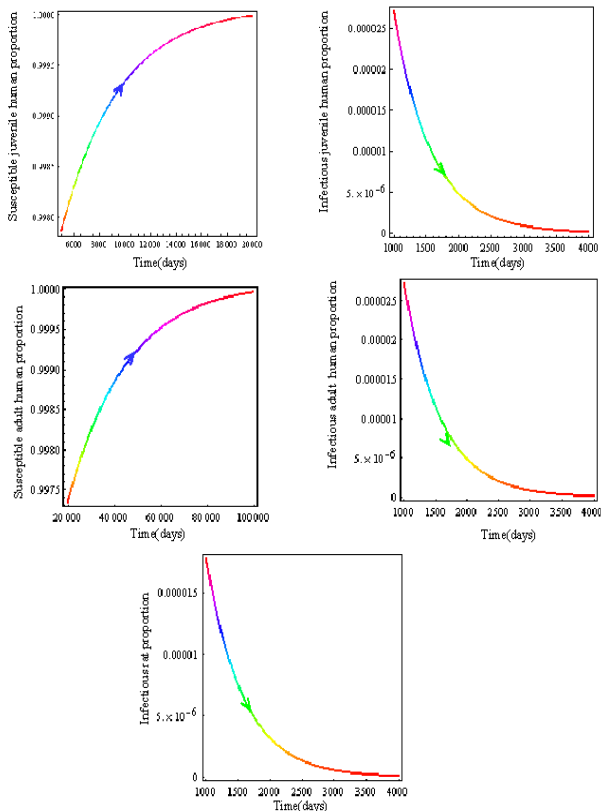

Fig. 4 Time series solutions of our dynamical equations. The parameters are $d = 1/(365 \times 70)$, $s = 1/15$, $\delta = 1/(365 \times 15)$, $\mu_R = 1/(365 \times 1.5)$, $N_J = 3,000$, $N_A = 7,000$, $\theta_J = 0.001$, $\theta_A = 0.01$, $\theta_R = 0.000001$, $N_R = 100$, $G_0 = 0.05475$.

We can see that the solutions approach to the disease free equilibrium state (1,01,0,0)

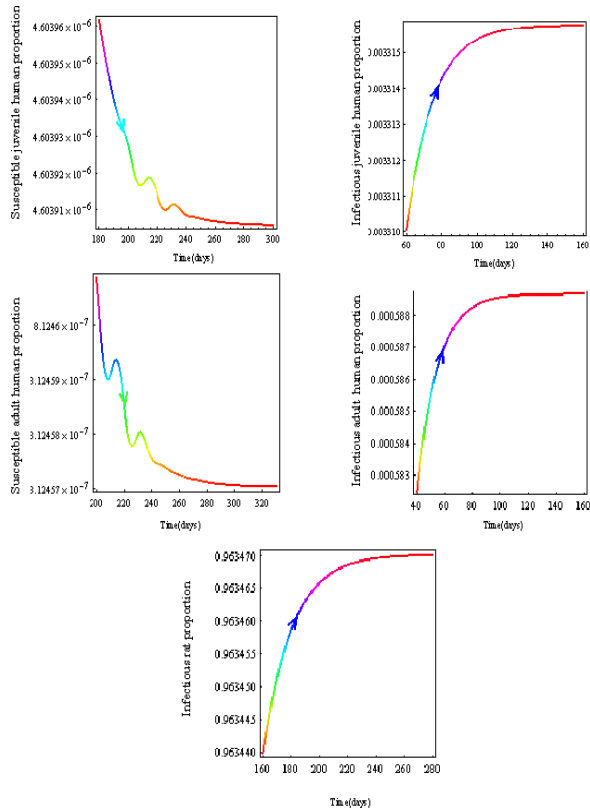
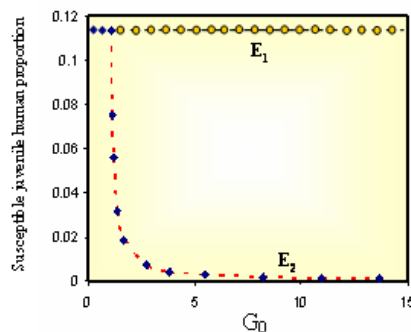

Fig. 5 Time series solutions of our dynamical equations. The parameters are $d = 1/(365 \times 70)$, $s = 1/15$, $\delta = 1/(365 \times 15)$, $\mu_R = 1/(365 \times 1.5)$, $N_J = 3,000$, $N_A = 7,000$, $\theta_J = 0.001$, $\theta_A = 0.01$, $\theta_R = 0.000001$, $N_R = 50,000$, $G_0 = 27.375$. We can see that the solutions converge to the disease endemic state (0.0000046,0.0033,0.00000081,0.00059,0.96)

From fig.5 and fig.6, we can see that the solutions converge to the disease free state and endemic disease state for $G_0 < 1$ and $G_0 > 1$, respectively



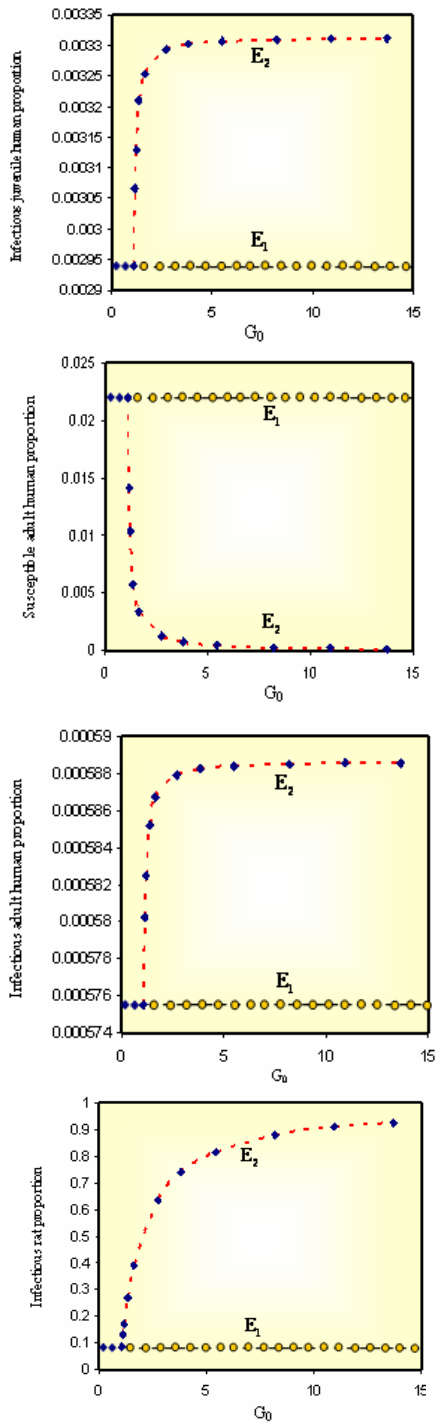

Fig. 6 Bifurcation diagrams of (10)-(14) demonstrate the equilibrium solutions of susceptible, infectious juvenile humans, susceptible, infectious adult humans and infectious rat populations, respectively for the different values of G_0 with $d = 1/(365 \times 70)$, $s = 1/15$, $\delta = 1/(365 \times 15)$, $\mu_R = 1/(365 \times 1.5)$, $N_J = 3,000$, $N_A = 7,000$, $\theta_J = 0.001$, $\theta_A = 0.01$, $\theta_R = 0.000001$. $\bullet\bullet\bullet$ represents the stable solutions and $\circ\circ\circ$ represents the unstable solutions. For $G_0 < 1$, E_1 will be stable. For $G_0 > 1$, E_2 will be stable

IV. CONCLUSION

The basic reproductive number of the disease (G_0) is defined as follows: $G_0 = \frac{\theta_R N_R}{\mu_R}$. From figure 6, if the basic reproductive number is higher, this means that one patient can produce the higher number of secondary cases. If the basic reproductive number is greater than one, the normalized susceptible juvenile and susceptible adult human decrease. The normalized infectious juvenile human, infectious adult human and infectious rat populations increase. The normalized infectious juvenile and adult human first increase to a peak and then decrease. This subsequent behavior occurs because there are enough susceptible juvenile human and adult human to be infected from infectious rat population. Furthermore, we compare the behaviors of time series of solutions when there is the different transmission rate of Leptospirosis between rat populations.

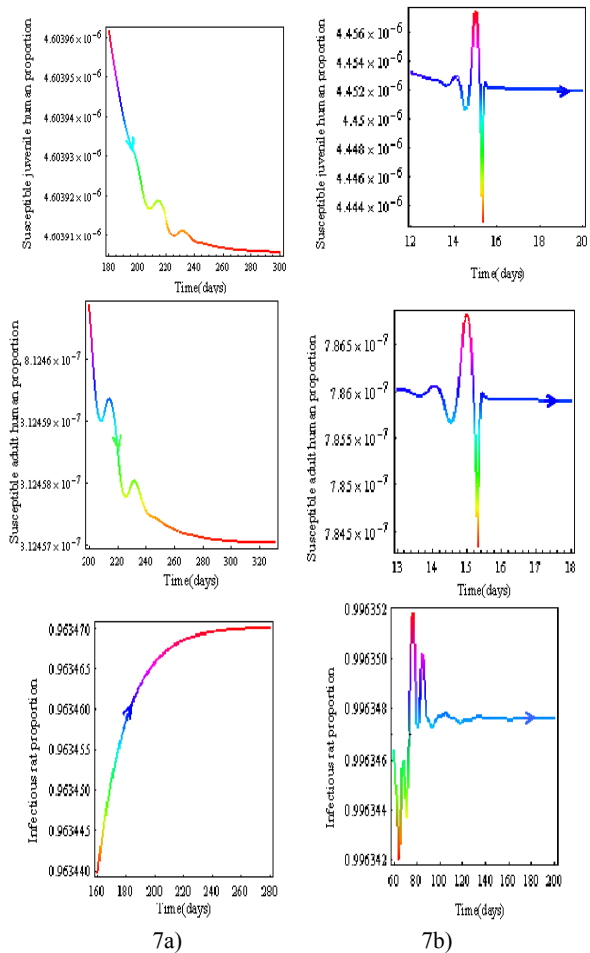

Fig. 7 Time series solutions of our dynamical equations. The parameters are $d = 1/(365 \times 70)$, $s = 1/15$, $\delta = 1/(365 \times 15)$, $\mu_R = 1/(365 \times 1.5)$, $N_J = 3,000$, $N_A = 7,000$, $\theta_J = 0.001$, $\theta_A = 0.01$, $N_R = 50,000$
 7a) $\theta_R = 0.000001, G_0 = 27.375$ 7b) $\theta_R = 0.000001, G_0 = 273.75$

We can see that when there is the smaller transmission rate of Leptospirosis between rat populations, the basic reproductive number (G_0) is higher and the duration of reducing the outbreak for this disease is smaller. The basic reproductive numbers are produced to be the alternative way for decreasing the outbreak of the diseases [14,15]. The output of this study should introduce the way for controlling the outbreak of Leptospirosis.

ACKNOWLEDGMENT

This work is supported by Faculty of Science, King Mongkut's Institute of Technology Ladkrabang, Thailand. Thailand. The author would like to thank Prof.Dr.I-Ming Tang at Mahidol University, Thailand. Numerical simulations are done by Thongoon Munmai.

REFERENCES

- [1] A.R. Bharti, J.E.Nally, J.N.Ricaldi, M.A.Matthias, M.M.Diaz, M.A.Lovett, P.N.Levett, R.H.Gilman, M.R.Willig, E.Gotuzzo, and J.M. "Leptospirosis: a zoonotic disease of global importance", *Lancet Infectious Diseases*, vol.12, pp.757-771, 2003.
- [2] W.Tangkanakul, H.L.Smits, S.Jatanasen, and D.A.Ashford, "Leptospirosis: an emerging health problem in Thailand", *Southeast Asian Journal of Tropical Medicine and Public Health*, vol.36,no.2, pp.281-288, 2005.
- [3] R. Inada , Y. Ido , and et al, "Etiology mode of infection and specific therapy of Weil's disease", *The Journal of Experimental medicine*, vol. 23, pp.377-402, 1916.
- [4] R. C. Abdulkader , A. C. Seguro , P. S. Malheiro , and et al, "Peculiar electrolytic and hormonal abnormalities in acute renal failure due to leptospirosis", *The American Journal of Tropical Medicine and Hygiene*, vol. 51, no. 1, pp. 1-6, 1996.
- [5] V. M. Arean , G. Sarasin, and J. H. Green, "The pathogenesis of leptospirosis: toxin production by leptospira icterohaemorrhagiae", *American Journal of Veterinary Research*, vol. 28, pp. 836-43, 1964.
- [6] V. M. Arean , "Studies on the pathogenesis of leptospirosis.II, A clinicopathologic evaluation of hepatic and renal function in experimental leptospira infections", *Laboratory Investigation*, vol. 11, pp.273-88, 1962.
- [7] S. Barkay , and H. Garzozzi , "Leptospirosis and uveitis," *Annals of Ophthalmology*, vol. 16, no. 2, pp. 164-8, 1984.
- [8] S. Faine, "Guideline for control of leptospirosis", *World Health Organization Geneva*, vol. 67, pp.129, 1982
- [9] J.Holt, S.Davis and H.Leirs, "A model of Leptospirosis infection in African rodent to determine risk to humans : Seasonal fluctuations and the impact of rodent control", *Acta Tropica*, vol. 99, pp. 218 – 225, 2006.
- [10] W. Triampo, D. Baowan, I. M. Tang, N. Nuttavut, J. Wong– Ekkabut and G. Doungchawee, "A Simple Deterministic Model for the Spread of Leptospirosis in Thailand," *International Journal of Biomedical Sciences*, vol 2, pp. 1306 –1216, 2007.
- [11] R. M. Anderson and R.M. May, *Infectious Diseases of Humans: Dynamics and Control*, Oxford University Press, Oxford, 1991.
- [12] Division of Epidemiology, *Annual Epidemiological Surveillance Report*, Ministry of Public Health, Royal Thai Government, 2002-2010.
- [13] Edelstein – Keshet, Leah, *Mathematical models in biology*, Random House of Canada, 1988.
- [14] P.Pongsumpun, and I. M . Tang, "Mathematical model for the transmission of Plasmodium Vivax Malaria," *International Journal of mathematical models and methods in applied sciences*, vol. 3, pp.117-121, 2007.
- [15] P.Pongsumpun, and I. M . Tang, "Limit Cycle and Chaotic Behaviors for the Transmission Model of Plasmodium Vivax Malaria ," *International Journal of mathematical models and methods in applied sciences*, vol.2, pp.563-570, 2008.

P. Pongsumpun received her B.Sc. degree in Mathematics (second class honors), Mahidol University, Thailand, in 1998, and her Ph.D. degree in Mathematics(International Programme), Mahidol University, Thailand, in 2004. From 2004 till date she is an assistant Professor of Mathematics, Ph.D.Thesis and M.Sc.advisors in King Mongkut's Institute of Technology Ladkrabang, Thailand. Her research interests are Mathematical modelling in medical science, differential equation and numerical analysis.