

Spectral Amplitude Coding Optical CDMA: Performance Analysis of PIIN Reduction Using VC Code Family

Hassan Yousif Ahmed, Ibrahima Faye, N.M.Saad and S.A. Aljined

Abstract—Multi-user interference (MUI) is the main reason of system deterioration in the Spectral Amplitude Coding Optical Code Division Multiple Access (SAC-OCDMA) system. MUI increases with the number of simultaneous users, resulting into higher probability bit rate and limits the maximum number of simultaneous users. On the other hand, Phase induced intensity noise (PIIN) problem which is originated from spontaneous emission of broad band source from MUI severely limits the system performance should be addressed as well. Since the MUI is caused by the interference of simultaneous users, reducing the MUI value as small as possible is desirable. In this paper, an extensive study for the system performance specified by MUI and PIIN reducing is examined. Vectors Combinatorial (VC) codes families are adopted as a signature sequence for the performance analysis and a comparison with reported codes is performed. The results show that, when the received power increases, the PIIN noise for all the codes increases linearly. The results also show that the effect of PIIN can be minimized by increasing the code weight leads to preserve adequate signal to noise ratio over bit error probability. A comparison study between the proposed code and the existing codes such as Modified frequency hopping (MFH), Modified Quadratic-Congruence (MQC) has been carried out.

Keywords—FBG, MUI, PIIN, SAC-OCDMA, VCC.

I. INTRODUCTION

TELECOMMUNICATION networks based on optical fiber technology have become a main information-system. Due to fact that, optical fiber provides an extremely high bandwidth compared to the traditional media.

The successful of long-span fiber optic communication systems has shifted the focus of optical network to shorter-span metropolitan and local area domains [1]. There is not

Hassan Yousif Ahmed is with the Electrical & Electronic Engineering Department, Universiti Teknologi PETRONAS, Bandar Seri Iskandar, 31750 Tronoh, Perak, MALAYSIA Tel: +605-368-8000 Fax: +605-365-7443 (e-mail: Hassan_uofg@yahoo.com)

Ibrahima Faye and N.M.Saad are with the Electrical & Electronic Engineering Department, Universiti Teknologi PETRONAS, Bandar Seri Iskandar, 31750 Tronoh, Perak, MALAYSIA Tel: +605-368-8000 Fax: +605-3657443 (email:ibrahima_faye@petronas.com.my, naufal_saad@petronas.co).

S.A. Aljined is with School of computer and communication Engineering, Universiti Malaysia Perlis, Malaysia.

much different between multiple access and multiplexing techniques, in simple word, multiple access allows communication media to be shared between different users, multiple access techniques represent one of the most essential functions of access networks while multiplexing is combination of signals into single transmission signal. The three basic multiple access techniques are Frequency Division Multiple Access (FDMA), Time Division Multiple Access (TDMA) and Code Division Multiple Access (CDMA). TDMA is a technology that allows multiple users to access a channel by allocating time slots to each user within each channel. WDMA is a technology allowing multiple users to access a channel by allocating wavelength or frequency to each user within each channel [1-5]. TDMA and WDMA have a limited bandwidth for every user.

CDMA was invented and used as the first technique for wireless communication. It gives best results compared to other wireless multiple access techniques. This fact led the researcher to study if the advantages of CDMA could also be utilized in optical communication systems. Optical CDMA is the latest multiple access technique has been proposed during the last twenty years after studies in the drawbacks of the previous multiple access technique. OCDMA systems likes wireless CDMA, each user is assigned with unique signature sequence called code word. An intelligent design of code words construction is a key to any successful CDMA system, either electrical or optical. However, codes based on $[-1, +1]$ signals, which are used in wireless CDMA system, cannot be applied in optical system because the signal is equivalent to instant power which is nonnegative [1, 2]. Optical fiber offers a much larger transmission band width and in CDMA every user is distinguished from the others by his unique code, hence the user can use the whole band width of the fiber optic media.

The key advantage of using OCDMA is that, OCDMA can be encoded and decoded in optical domain without converting the signal to electronic unless it needed to be. In OCDMA, the multi user interference (MUI) [2] is the ultimate limit in system performance. MUI increases with the number of simultaneous users and severely limits the capacity of the system. Although MUI can be cancellation by balance detection scheme, inherently problem of noise still remains labeled as phase induced intensity noise (PIIN) arising from spontaneous emission of broad band source. To suppress it, an intelligent design of codeword with low cross correlation is

important to reduce the effect of MUI and PIIN to total received [3].

The rest of this paper is organized as follows. A review of OSDMA system is presented in section II. The families of newly constructed codes are described in Section III. Section IV demonstrates the encoder-decoder structure. Section V presents the analytic results of system performance. The properties of these codes are discussed from view of comparison in section VI. Theoretical analysis and simulation results are shown in Section VII. Finally, we have the conclusion in Section VIII.

II. SAC-OCDMA SYSTEMS

Optical spectrum (OSCDMA) is an incoherent broadband light source which contains N user with optical transmitters and receivers [4]. OSDMA system contains encoders and decoders which can be designed by using any kind of optical filtering technology. In this system, the signature sequence is spread across different wavelength with each chip occupying different wavelength [4-11].

The advantage of OSDMA is it does not need synchronization as the chip spreads in frequency and not in time. (See Fig. 1)

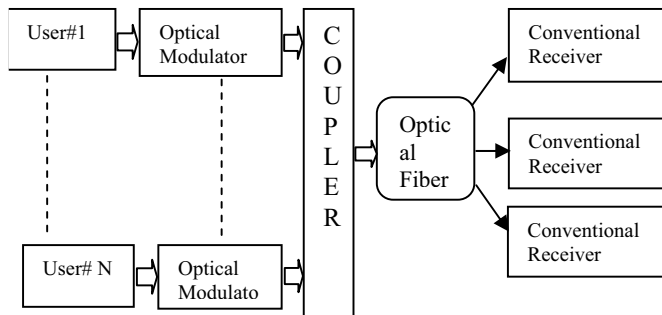

Fig. 1 Schematic diagram of OSDMA

Recently several spectral amplitude coding for OCDMA codes have been proposed such as Hadamard code [4], integer lattices [5], modified quadratic congruence (MQC) [6], modified frequency hopping (MFH) [7], modified double code (MDW) [8], and enhance double weight (EDW) [9]. However, recent studies showed that, an OCDMA cannot be designed only by considering the cross correlation properties. The length plays an important role and we should be addressed as well. Long length is a disadvantage since the code is subject to either very wide band source or narrow filter bandwidths are required while short length limits the freedom of code selection. Therefore, a tradeoff between the number of code words and code lengths must be made.

In this paper, we have constructed three codes families called ideal vector combinatorial (IVC), none-ideal vector combinatorial (NVC) and vector combinatorial (VC) codes with ideal in-phase cross correlation (λ_c) for SAC-OCDMA system, based on combination of specific vectors and combinatorial theories. These new codes families are

constructed in a simple algebraic way while maintaining the interference-cancellation property. The construction based on the number of users N and weight W for the conditions $N-I=W$, $N-I<W$ and $N-I>W$ and exist for convenient length that are neither too long nor too short.

III. CODE CONSTRUCTION AND PROPERTIES

Let \mathbf{R} denotes the field of real numbers. The space of all W -tuples of real numbers forms a W -dimensional vector space over \mathbf{R} denoted by \mathbf{R}^W [12]. An element y of \mathbf{R}^W can be written as a column vector as in (1):

$$\mathbf{x} = \begin{pmatrix} x_1 \\ x_2 \\ \vdots \\ x_N \end{pmatrix} \quad (1)$$

Based on above definition considering the parameters (W, N) , let y_j be a column vector where j is a positive integer in a set \mathbf{R}^W having "0s" at all rows (users) except row j whose magnitude is "1". The sequence y_1, y_2, \dots, y_W is a basis of \mathbf{R}^W , called the standard basis. For \mathbf{R}^4 (i.e., $W=4$), the columns vectors can be constructed as shown in (2a), (2b), (2c) and (2d) according to j position.

$$\mathbf{y}_1 = \begin{pmatrix} 1 \\ 0 \\ 0 \\ 0 \end{pmatrix} \quad (2a)$$

$$\mathbf{y}_2 = \begin{pmatrix} 0 \\ 1 \\ 0 \\ 0 \end{pmatrix} \quad (2b)$$

$$\mathbf{y}_3 = \begin{pmatrix} 0 \\ 0 \\ 1 \\ 0 \end{pmatrix} \quad (2c)$$

$$\mathbf{y}_4 = \begin{pmatrix} 0 \\ 0 \\ 0 \\ 1 \end{pmatrix} \quad (2d)$$

Based on the above assumptions, the proposed code can be constructed by using the following steps:

$$Y_{(j,j+1)} = \begin{pmatrix} 1 \\ 0 \\ \cdot \\ \cdot \\ 1 \end{pmatrix} \quad (3)$$

Step1: Let $Y(j, j+1)$ be a column vector whose j th element is one and others are zero and its length N (Eq. 3). Fig. 2 represents a general matrix of the proposed system after combining all columns vectors using (3) based on W and N values. From the figure, we can observe that each column vector contains two "1"s, W represents number of "1"s per row and N is the number of rows.

Step 2: in order to make the in-phase CC exactly equal to 1 in each column while maintaining the weight value in the row (code word for each user), every vector in the matrix (Fig. 2) is indexed as $Y(j, j+1)$ for j fixed to denote user arrangement and $j+1$ shifts to the down by one up to N to make the CC with $N-1$ is exactly equal to 1 (i.e., for $j=1, N=5, Y(j, j+1) = Y_{12}, Y_{13}, Y_{14}, Y_{15}$; for $j=2, N=5, Y(j, j+1) = Y_{23}, Y_{34}, Y_{35}$; for $j=3, N=5, Y(j, j+1) = Y_{34}, Y_{35}$; for $j=4, N=5, Y(j, j+1) = Y_{45}$;) which means j represents number of row (user). Therefore, the sequence

$(Y_{12}Y_{13}\dots Y_{1N})(Y_{23}Y_{24}\dots Y_{2N})\dots(Y_{(N-1)N})$ gives a code having ideal in-phase CC ($\lambda=1$) called Ideal Case (IC).

Step3: By using an IC, the new code families can be constructed when applying the conditions $N-1=W, N-1<W$ and $N-1>W$ for IVC, NVC and VC respectively as shown in Fig. 3.

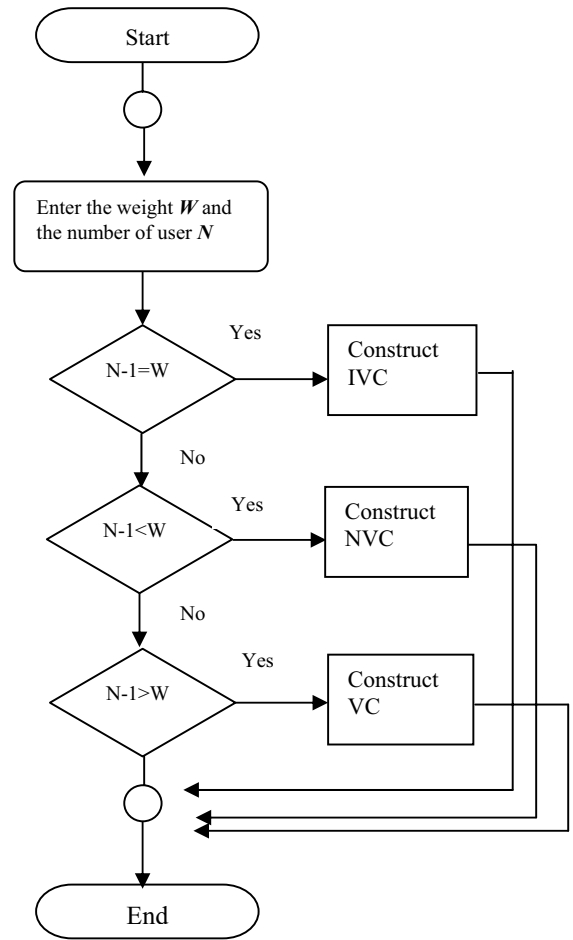

Fig. 3: flowchart of proposed system

From Fig. 3, we can analyze the code conditions as follows:

- If $N-1=W$, (where $N=4$ and $W=3$), the column vector can be constructed as follows:

$$y_{12} = \begin{pmatrix} 1 \\ 1 \\ 0 \\ 0 \end{pmatrix}, y_{13} = \begin{pmatrix} 1 \\ 0 \\ 1 \\ 0 \end{pmatrix}, y_{14} = \begin{pmatrix} 1 \\ 0 \\ 0 \\ 1 \end{pmatrix}, y_{23} = \begin{pmatrix} 0 \\ 1 \\ 1 \\ 0 \end{pmatrix}, y_{24} = \begin{pmatrix} 0 \\ 1 \\ 0 \\ 1 \end{pmatrix}, y_{45} = \begin{pmatrix} 0 \\ 0 \\ 1 \\ 1 \end{pmatrix}$$

Therefore, the code patterns for IVC can be generated as shown in Table I

TABLE I IVC CODE FOR $N=W+1$

1	1	1	0	0	0
1	0	0	1	1	0
0	1	0	1	0	1
0	0	1	0	1	1

Open Science Index, Electronics and Communication Engineering Vol:3, No:4, 2009 publications.waset.org/7709/pdf

(i,i+1)	Y_1	Y_1	...	Y_1	Y_2	Y_2	...	Y_2	$Y_{(N-1)N}$
ser# 1	2	3	·	N	3	4	·	N	0
ser# 2	1	1	...	1	0	0	...	0	0
	1	0	...	0	1	1	...	1	0
	0	1	...	0	1	0	...	0	0
	0	0	...	·	0	1	...	·	·
	0	0	...	·	0	0	...	·	·
	0	0	...	·	0	0	...	·	1
User# N	0	0	...	1	0	0	...	1	1

Fig. 2: A general matrix of IC

TABLE II NVC CODE FOR $N < W+1$

1	1	0	1	0	0
1	0	1	0	1	0
0	1	1	0	0	1

- If $N-1 < W$ (where $N=3, W=3$), the column vector can be constructed as follows:

$$y_{12} = \begin{pmatrix} 1 \\ 1 \\ 0 \end{pmatrix}, y_{13} = \begin{pmatrix} 1 \\ 0 \\ 1 \end{pmatrix}, y_{23} = \begin{pmatrix} 0 \\ 1 \\ 1 \end{pmatrix}, y_1 = \begin{pmatrix} 1 \\ 0 \\ 0 \end{pmatrix}, y_2 = \begin{pmatrix} 0 \\ 1 \\ 0 \end{pmatrix}, y_3 = \begin{pmatrix} 0 \\ 0 \\ 1 \end{pmatrix}$$

We need to increase the weight from $N-1$ to W without increasing the CC to satisfy the condition $N-1=W$ (i.e., y_{12}, y_{13} and y_{23}). Therefore, a zero-CC with the parameters $(W-N+1, N)$ must be added (i.e., y_1, y_2 and y_3 repeated $W-N+1$ times). The length for this zero-CC is $N(W-N+1)$. Finally, the length for the whole sequence will be

$$L = N \times (2W-N+1)/2 \quad (4)$$

Therefore, the code pattern for NVC can be generated as shown in Table II.

- If $N-1 > W$ (where $N=5, W=3$).

Although the IC can be constructed easily using a column vector, the requirement that $N-1=W$ must be satisfied limits the number of users, to overcome this problem, a mapping technique must be applied based the condition $N-1 > W$, thus, the column vector can be constructed as follows (see Fig. 4):

$$e_{12} = \begin{pmatrix} 1 \\ 1 \\ 0 \\ 0 \end{pmatrix}, e_{13} = \begin{pmatrix} 1 \\ 0 \\ 1 \\ 0 \end{pmatrix}, e_{14} = \begin{pmatrix} 1 \\ 0 \\ 0 \\ 1 \end{pmatrix}, e_{23} = \begin{pmatrix} 0 \\ 1 \\ 1 \\ 0 \end{pmatrix}, e_{24} = \begin{pmatrix} 0 \\ 1 \\ 0 \\ 1 \end{pmatrix}, e_{34} = \begin{pmatrix} 0 \\ 0 \\ 1 \\ 1 \end{pmatrix}$$

Therefore, N can be written as:

$$N = P(W+1) + R \quad (5)$$

Where P, R are positive integer numbers represent number of $(W+1)$ repeating in diagonal fashion (see Fig. 4), and the remaining users after module division for N respectively, therefore R can be expressed as:

$$R = N \bmod P(W+1) \quad (6)$$

To clarify (5) and (6) where \bmod represents modulo division, for example let $N=18, W=5$, substitute the values in (5), (6), gives $18=3 \times (5+1) + 0$, which means $P=3$ and $R=0$. For $N=17, W=4$, gives $17=3 \times (4+1) + 2$ which means $P=3$ and $R=2$. In order to increase the number of users in the VC code family, a mapping technique must be applied.

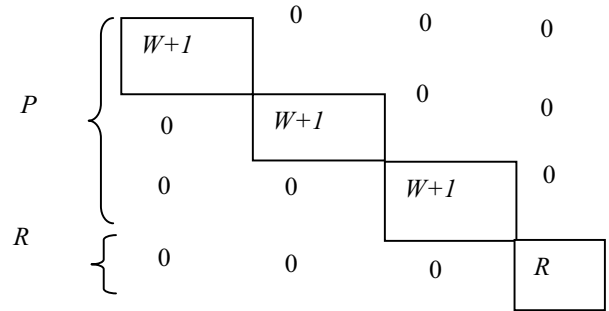

Fig. 4: A graphic representation of mapping techniques for $N = P(W+1) + R$

The mapping technique (see Fig. 4) operates by repeating the IC in diagonally fashion for the $(W+1)$ users P -times and filling the empty spaces with zeros. The length of that part is $P \cdot \frac{W(W+1)}{2}$. Consequently, an IC with the parameters (W, R) must be added if $R < W+1$ is satisfied (i.e., $R = N \bmod P(W+1) \neq 0$) (see Fig. 4). The length of that second part of the code is $\frac{R \times (2W - R + 1)}{2}$. Finally, the whole length L is given by:

$$L = \frac{PW(W+1)}{2} + \frac{R(2W - R + 1)}{2} = \frac{WN + R(W+1 - R)}{2} \quad (7)$$

In Table III, $W = 3$ and $N=5$ gives $5=1 \times 4+1$, resulting $P=1$ and $R=1$. By using (7), the length will be 9. There are two groups, the first group of the code (the first six columns) is the IC with the ideal parameters (3,4) having CC equals to 1, the second group (the columns from 7 to 9) is the IC with the parameters (3,1) having CC equals to 1.

Properties of VC codes:

- VCC code has the following properties.
- The cross-correlation is fixed to one.
- Always the number of users equal $P(W+1)+R$
- The weigh can be any number.

TABLE III VC CODE FOR $N > W+1$

1	1	1	0	0	0	0	0	0
1	0	0	1	1	0	0	0	0
0	1	0	1	0	1	0	0	0
0	0	1	0	1	1	0	0	0
0	0	0	0	0	0	1	1	1

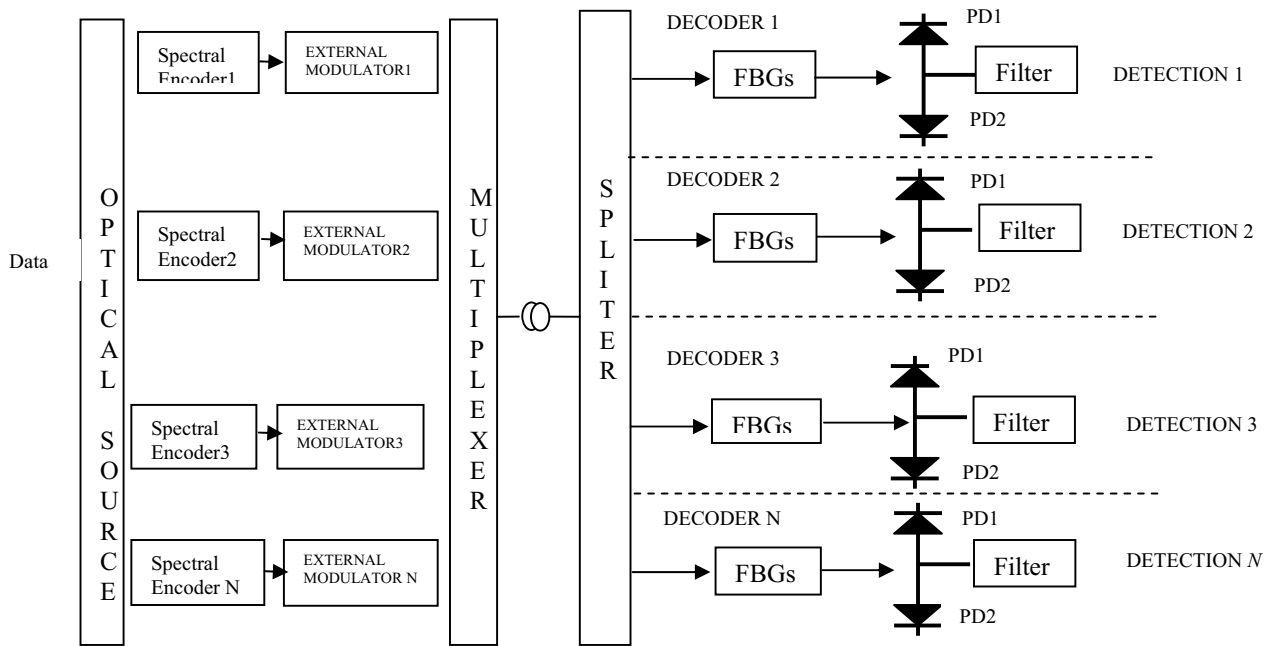

Fig. 5: A general block diagram of proposed system consist N Encoder and N Decoder

IV. PERFORMANCE ANALYSIS

The signal to noise ratio (SNR) of the IVC, NVC and VC codes is calculated by using the same method described in [5-9], and is given by the formulas (8), (9) and (10) respectively. The photodiode shot noise and the thermal noises are taken into account. Therefore, the SNR of IVC code family is given by:

$$SNR = \frac{\Re^2 P_{sr}^2 W^2}{\frac{P_{sr} e B \Re}{L} [(2N-2)+W] + \frac{P_{sr}^2 B \Re^2 N W}{2 \Delta V L^2} [(2N-2)+W] + \frac{4 K_B T_n B}{R_L}} \quad (8)$$

The SNR of NVC code family is given by

$$SNR = \frac{\Re^2 P_{sr}^2 W^2}{\frac{P_{sr} e B \Re}{L} [(2N-2)+W] + \frac{P_{sr}^2 B \Re^2 N W}{2 \Delta V L^2} [(2N-2)+W] + \frac{4 K_B T_n B}{R_L}} \quad (9)$$

The SNR of VC code family is given by

$$SNR = \frac{\Re^2 P_{sr}^2 W^2}{\frac{P_{sr} e B \Re}{L} [(N-1)+W] + \frac{P_{sr}^2 B \Re^2 N}{2 \Delta V L^2} [(N-1)+W+(N-1)/P+R] + \frac{4 K_B T_n B}{R_L}} \quad (10)$$

Where \Re is the photodiode responsivity, P_{sr} is the effective power of a broad-band source at the receiver, e is the electronic charge, B is the electrical equivalent noise bandwidth of the receiver, K_B is the Boltzmann's constant, T_n the

absolute receiver noise temperature, R_L is the receiver load resistor, ΔV is the optical source bandwidth, W , N , L , P and R are the code weight, the number of users, the code length, the number of mapping and the remaining of N after modulo operation respectively as being the parameters of IVC, NVC and VC codes. The Bit Error Rate (BER) is computed from the SNR using Gaussian approximation as [7]

$$BER = P_e = \frac{1}{2} \operatorname{erfc} \left(\sqrt{\frac{SNR}{8}} \right) \quad (11)$$

A good SNR corresponds to a small BER. For numerical simulations, we used the following parameters: $\Delta V=3.75$ THz is the line width of the broad band source, $B=311$ MHz is the receiver noise-equivalent electrical bandwidth, $T_n = 300$ K, $R_L=1030 \Omega$, bit-rate 155 Mb/s, $\eta=0.6$ is the photodiode quantum efficiency and $\lambda=1550$ nm is the operating wavelength.

V. CODE EVALUATION AND COMPARISON

For comparison, the properties of VC, MQC, and MFH are listed in Table IV. Table IV shows the codes lengths required by MQC ($p=7$), MFH ($q=7$, $n=1$) and VC ($W=2$, $p=16$, $R=1$) to support 49 users. From the table we can observe that, VC provides better performance than other codes for same number of users in terms of code length. Long length is a disadvantage since the code is subject to either very wide band source or narrow filter bandwidths are required while short length limits the freedom of code selection. The VC exists for a practical length that is neither too long nor too short.

TABLE IV COMPARISON OF VC, MQC AND MFH FOR THE SAME NUMBER OF USERS, N=49

Code	Number of users	Weight	λ	Code length
MQC	49	7	1	56
MFH	49	7	1	56
VCC	49	2	1	50

VI. STRUCTURE OF TRANSMITTER AND RECEIVER

Fig. 5 shows a general block diagram of proposed system which consists three parts including the encoder part, the fiber optic as medium, and the decoder. In Fig. 5, ON-OFF shift keying modulation is used to modulate the information bits for the desire user, and then the result of optical signal is directed to FBGs, where each chip of the VC has been attributed with a specific wavelength. The decoding process is similar to conventional SAC systems, and could be achieved by passing the receiving signal through two FBG arrays assigned by the weight and its complementary then recover the signal differentially to reproduce the desire signal.

VII. SIMULATION RESULT AND DISCUSSION

Fig. 6 shows the PIIN plotted against the received power for the NVC, IVC and VC using the parameters: $W=4$, data rate 622Mb/s, 2.5Gb/s and 10Gb/s respectively. From the figure we can observe that when the received power increases, the PIIN noise for all the codes increases linearly. The PIIN noise of VC code family is less compared to that of IVC and NVC codes. Moreover the PIIN noise can be effectively suppressed by using VC code family. This is because by using mapping techniques, the power of interference from other users is reduced with the increase of the code length, and eventually eliminates the MUI effects.

Fig. 7 show the PIIN plotted against the received power for the VC, MQC and MFH using the parameters: $W=4, 14$ and 17 for VC, MQC and MFH respectively at data rate 10Gb/s. From the figure we can observe that when the received power increases, the PIIN noise for all the codes increases linearly. The PIIN noise of VC code family is less compared to that of IVC and NVC codes. Moreover the PIIN noise can be effectively suppressed by using VC code family. This is because by using mapping techniques, the power of interference from other users is reduced with the increase of the code length, and eventually eliminates the MUI effects. Also we shown in Fig 7, when the code weight is increased, the PIIN noise can further be suppressed.

Fig 8 shows the relation between number of active users and the PIIN noise for IVC, NVC and VC codes. In Fig 8, the parameters values are: $W=4, 5$, and 4 $p=2$ for IVC, NVC and

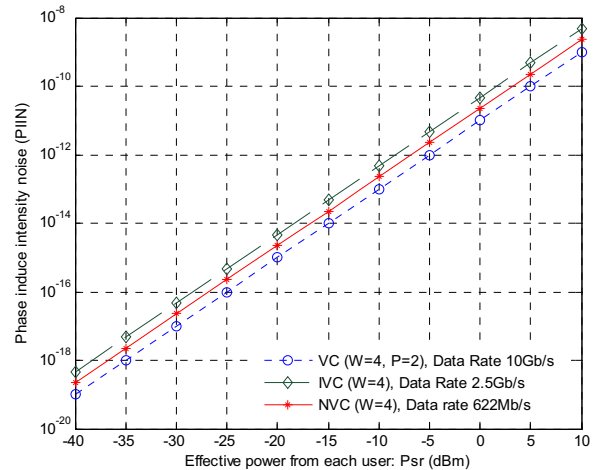

Fig. 6: PIIN Noise versus Received Power for IVC, NVC and VC codes at different data rates for $W=4$.

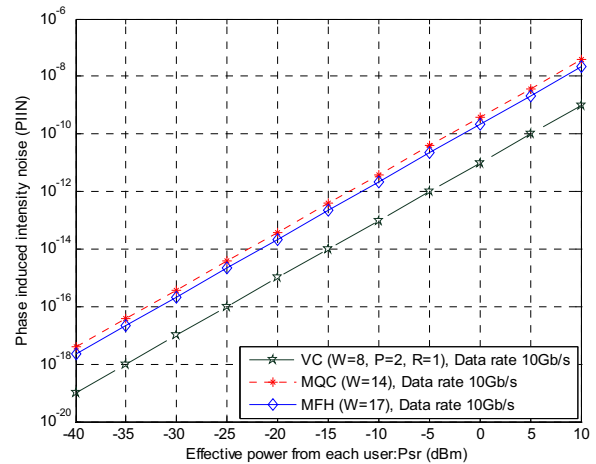

Fig. 7: PIIN Noise versus Number of Active Users for VC, MQC and MFH codes at data rate 10Gb/s for different values of W .

VC respectively; the bit rate is 622Mb/s; $P_{sr} = -10$ dBm but number of users N varied from 1 to 100.

The figure clearly shows that, for VC code family, the PIIN noise will be maintained when the number of active user increases. This is due to the good properties of the code sequences and mapping technique.

Fig 9 shows the relation between number of active users and the PIIN noise for VC, MQC and MFH codes. In Fig 9, the parameters values are: $W=8, 10, 4$ and 4 $p=2$ for MQC, MFH and VC respectively; the bit rate is 622Mb/s; $P_{sr} = -10$ dBm but number of users N varied from 1 to 100. The figure clearly shows that, for VC code family, the PIIN noise will be maintained when the number of active user increases. This is due to the good properties of the code sequences and mapping technique. On the other hand, for MQC and MFH codes the PIIN noise increase when the number of active user increases.

REFERENCES

- [1] J. A. Salehi, "Code division multiple access techniques in optical fiber network—Par I: Fundamental principles," IEEE Trans. Commun., vol.37, pp. 824–833, Augst 1989.
- [2] A. Stok and E. H. Sargent, Lighting the local network: Optical code division multiple access and quality of service provisioning, IEEE Network, vol. 14, no. 6, pp. 42–46, Nov. 2000.
- [3] H. Fathallah et al, IEEE/OSA Journal of Lightwave Technology, vol. 17, no. 3, pp. 397-405, 1999.
- [4] M. Kavehrad, and D. Zaccarh, "Optical Code-Division-Multiplexed Systems Based on Spectral Encoding of Noncoherent Sources," Journal of Lightwave Technology, vol. 13, March 1995
- [5] Ivan B. Djordjevic and Bane Vasic, "Combinatorial Constructions of Optical Orthogonal Codes for OCDMA Systems". Journal of Lightwave Technology, vol. 21, September 2003.
- [6] Zou Wei, H. M. H. Shalaby, H. Ghafouri-Shiraz, "Modified Quadratic Congruence codes for Fiber Bragg-Grating-Based SAC-OCDMA," Journal of Lightwave Technology, vol. 50, , pp. 1209-1212, August 2002.
- [7] Zou Wei, H. Ghafouri-Shiraz, "Codes for Spectral-Amplitude- Coding Optical CDMA Systems," Journal of Lightwave Technology, Vol. 50, pp. 1209-1212, August 2002.
- [8] S.A.Aljunid, M.Ismail, A.R.Ramli, Borhanuddin M. Ali, and Mohamad Khazani Abdullah, "A New Family of Optical Code Sequences for Spectral-Amplitude-Coding Optical CDMA Systems" IEEE Photonics Technology Letters, vol. 16, October 2004
- [9] Mohamad Khazani Abdullah , Feras N. Hasoon , S.A. Aljunid , Sahbudin Shaari," Performance of OCDMA systems with new spectral direct detection (SDD)technique using enhanced double weight (EDW) code" ScienceDirect, Optics Communications, vol . 281, pp 4658–4662, June 2008.
- [10] [Chao-Chin Yang "Hybrid Wavelength-Division Multiplexing/Spectral-Amplitude-Coding Optical CDMA System"IEEE Photon. Technol. Lett., vol. 17, No. 6, June. 2005.
- [11] [12] Cheing-Hong lin,Jingshown Wu,Chun-Liang Yang, "noncoherent Spatial/Spectral optical CDMA System with two dimensional Perfect Difference Codes ," Journal of Lightwave Technology, vol. 23, pp. 1209-1212, December 2005.
- [12] Kelley, John L. (1975). General Topology. Springer-Verlag. ISBN 0-387-90125-6. http://en.wikipedia.org/wiki/Euclidean_space.

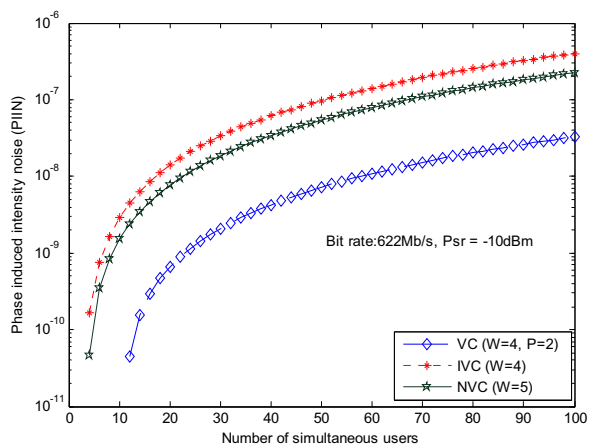

Fig. 8: PIIN Noise versus Number of Active Users for IVC, NVC and VC codes at data rate 622Mb/s when Psr = -10dBm.

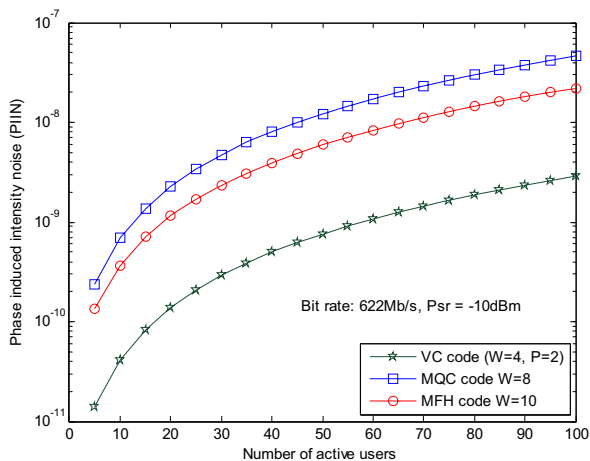

Fig. 9: PIIN Noise versus Number of Active Users for VC, MQC and MFH codes at data rate 622Mb/s when Psr = -10dBm.

VIII. CONCLUSION

In this paper, we have proposed new codes families can effectively suppress the MUI and PIIN. The properties and theoretical development of new families have been proved and discussed with the related equations. New structures of both transmitter and receiver sides have been designed using FBG groups. To conclude, the advantages of the codes can be summarized as follows: 1) any positive integer number of weights can be used; 2) large flexibility in choosing the number of users (free cardinality) over other codes like MQC and MFH; 3) simplicity of code construction; 4) maximum cross correlation is one and exists for a practical code length. The new structures of transmitter and receiver have been analyzed using VC families taking into consideration the effect of intensity noise, thermal noise and shot noise. The results reveal that, the VC families using small values of W with a mapping technique outperforming the MQC and MFH in many perspectives.



Hassan Yousif Ahmed received the B.Eng. in Computer Engineering (Network) and M.Sc in Computer Science and Information from Gezira University, Sudan in 2002 and 2007 respectively. His research interests are on Computer Network, wireless communications networks, optical communications, and he is currently working toward Ph.D degree in optical communications, working at University Teknologi PETRONAS department of Electrical and Electronic, Malaysia