

# Kinematics and Control System Design of Manipulators for a Humanoid Robot

S. Parasuraman

**Abstract**—In this work, a new approach is proposed to control the manipulators for Humanoid robot. The kinematics of the manipulators in terms of joint positions, velocity, acceleration and torque of each joint is computed using the Denavit Hardenberg (D-H) notations. These variables are used to design the manipulator control system, which has been proposed in this work. In view of supporting the development of a controller, a simulation of the manipulator is designed for Humanoid robot. This simulation is developed through the use of the Virtual Reality Toolbox and Simulink in Matlab. The Virtual Reality Toolbox in Matlab provides the interfacing and controls to an environment which is developed based on the Virtual Reality Modeling Language (VRML). Chains of bones were used to represent the robot.

**Keywords**—Mobile robot, Robot Kinematics, Robot Navigation, MATLAB.

## I. INTRODUCTION

IN this work, the model of an anthropomorphic arm design was used as a reference. This model consists of a mobile robot which has wheels as its base, two five degree of freedom arm and a 2 degree of freedom torso. The designed robot is as shown in Fig. 1. The design of the proposed model is motivated by the work done by Nortman, S. et al [5], [1], [3] and [4]. The entire robot was designed using Solid works.

In Fig. 1, additional four finger gripper attached to the robot. This mobile robot is designed based on the actual anthropomorphic data of a male in UK. The following section of the work will illustrate the various analyses which are performed on the robot. In this section, the detailed analysis of the designed anthropomorphic robot will be illustrated. This includes the kinematics analysis (forward and inverse kinematics), describing the velocities and static forces through the robot dynamics. However, due to the complexity of this mechanism, the problem is decomposed into several modules namely, the waist to torso, five degree of freedom arm and the gripper fingers.

The following section illustrates the robot kinematics for the entire robot from the waist to the end of the arm.

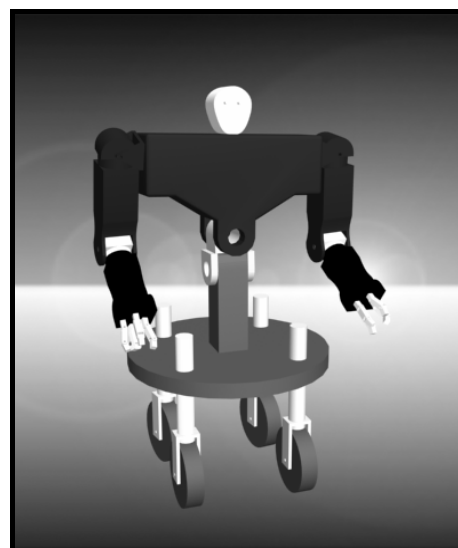

Fig. 1 Anthropomorphic Mobile Robot Design

## II. THEORETICAL WORK

### A. Modeling the Waist to Torso

The first module is to analyze the robot from the waist to its torso. Fig. 2 shows the designed waist to torso.

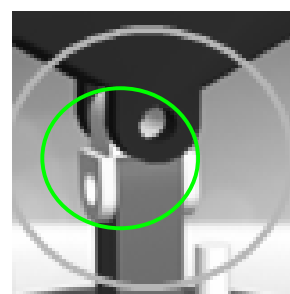

Fig. 2 Waist to Torso Design

TABLE I  
DH TABLE

Joint No.	$a_{i-1}$	$\alpha_{i-1}$	$d_i$	$\theta_i$
w <sub>1</sub>	0	0	0	$\theta_{w1}$
w <sub>2</sub>	$L_w$	90	0	$\theta_{w2}$
s	$L_t$	0	0	90
a	$L_s$	0	0	-90

S. Parasuraman is with the Monash University Sunway Campus, Bandar Sunway, 46150, Malaysia (phone: +603 55146254; fax: +603 55146207; e-mail: s.parasuraman@eng.monash.edu.my).

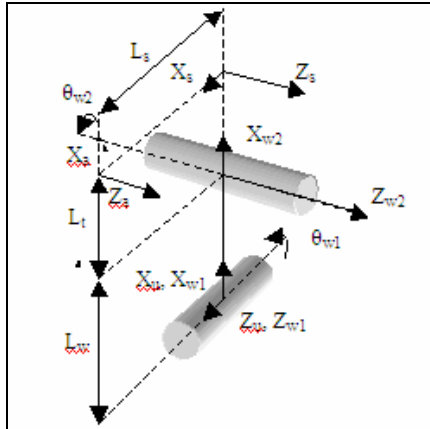

Fig. 3 Frame assignment of Waist to Torso Design

$${}^u_s T = {}^u_{w1} T \cdot {}^{w1}_{w2} T \cdot {}^{ws}_s T$$

$${}^u_s T = \begin{bmatrix} r_{11} & r_{12} & r_{13} & p_x \\ r_{21} & r_{22} & r_{23} & p_y \\ r_{31} & r_{32} & r_{33} & p_z \\ 0 & 0 & 0 & 1 \end{bmatrix}$$

where

$$\begin{aligned} r_{11} &= c_{w1}c_{w2}, \\ r_{12} &= -c_{w1}s_{w2}, \\ r_{13} &= s_{w1}, \\ r_{21} &= s_{w1}c_{w2}, \\ r_{22} &= -s_{w1}s_{w2}, \end{aligned}$$

$$= \begin{bmatrix} -c_{w1}c_{w2}L_s \dot{\theta}_{w2} - c_{w1}c_{w2}L_s \dot{\theta}_{w3} - c_{w1}s_{w2}L_t \dot{\theta}_{w2} + s_{w1}(-L_t c_{w2} - L_w + L_s s_{w2}) \dot{\theta}_{w1} \\ -s_{w1}c_{w2}L_s \dot{\theta}_{w2} - s_{w1}c_{w2}L_s \dot{\theta}_{w3} - s_{w1}s_{w2}L_t \dot{\theta}_{w2} - c_{w1}(-L_t c_{w2} - L_w + L_s s_{w2}) \dot{\theta}_{w1} \\ -s_{w2}L_s \dot{\theta}_{w2} - s_{w2}L_s \dot{\theta}_{w3} + c_{w2}L_t \dot{\theta}_{w2} \end{bmatrix} \quad (5)$$

$$= \begin{bmatrix} s_{w1}(-L_t c_{w2} - L_w + L_s s_{w2}) & -c_{w1}(c_{w2}L_s + s_{w2}L_t) & -c_{w1}c_{w2}L_s \\ -c_{w1}(-L_t c_{w2} - L_w + L_s s_{w2}) & -s_{w1}(c_{w2}L_s + s_{w2}L_t) & -s_{w1}c_{w2}L_s \\ 0 & -s_{w2}L_s + c_{w2}L_t & -s_{w2}L_s \end{bmatrix} \begin{bmatrix} \dot{\theta}_{w1} \\ \dot{\theta}_{w2} \\ \dot{\theta}_{w3} \end{bmatrix} \quad (6)$$

The joint position and velocity the end effector relative to origin is obtained using the equation (2) and (6) respectively.

### B. Modeling the 5 DOF Robot Arm

The second module is the 5DOF arm which is directly connected to the torso as shown in Fig. 1. Although there are two arms on the robot, however, providing the analysis on one arm will be sufficient since both arms are identical. Fig. 4 used in the control system design.

$$\begin{aligned} r_{23} &= -c_{w1}, \\ r_{31} &= s_{w2}, \\ r_{32} &= c_{w2}, \\ r_{33} &= 0, \\ p_x &= -c_{w1}s_{w2}L_s + c_{w1}c_{w2}L_t + c_{w1}L_w \\ p_y &= -s_{w1}s_{w2}L_s + s_{w1}c_{w2}L_t + s_{w1}L_w \\ p_z &= c_{w2}L_s + s_{w2}L_t \end{aligned}$$

$$\theta_2 = \text{Atan2}(r_{31}, r_{32})$$

$$\theta_1 = \text{Atan2}(r_{13}, -r_{23}) \quad (2)$$

### Velocities and Static Forces:

$${}^{i+1}w_{i+1} = {}^{i+1}_i R^i w_i + \theta_{i+1} \hat{Z}_{i+1} \quad (3)$$

$${}^{i+1}v_{i+1} = {}^{i+1}_i R \left( {}^i v_i + {}^i w_i \times {}^i p_{i+1} \right) \quad (4)$$

$${}^0 v_4 = {}^0 R^4 v_4$$

$$= \begin{bmatrix} c_{w1}c_{w2} & -c_{w1}s_{w2} & s_{w1} \\ s_{w1}c_{w2} & -s_{w1}s_{w2} & -c_{w1} \\ s_{w2} & c_{w2} & 0 \end{bmatrix} \begin{bmatrix} -L_s \dot{\theta}_{w2} - L_s \dot{\theta}_{w3} \\ L_t \dot{\theta}_{w2} \\ (-L_t c_{w2} - L_w + L_s s_{w2}) \dot{\theta}_{w1} \end{bmatrix}$$



Fig. 4 5DOF Arm Design

Joints ShoulderA, ShoulderB, and ElbowA are coincident at the shoulder. This alignment allows for the arm to rotate as if a ball and socket joint were implemented. ElbowB and WristA joints are also coincident.

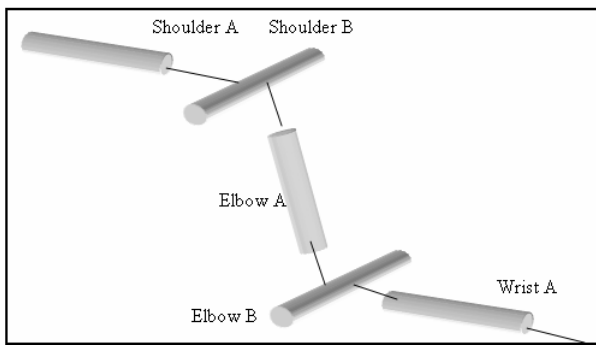

Fig. 5 Kinematics of 5DOF Arm Links

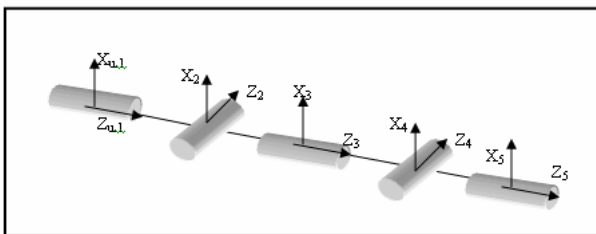

Fig. 6 Frame assignments of 5DOF Arm Links

TABLE II  
 DH TABLE

Joint No.	$a_{i-1}$	$\alpha_{i-1}$	$d_i$	$\theta_i$
1	0	0	0	$\theta_1$
2	0	90	0	$\theta_2$
3	0	-90	$d_3$	$\theta_3$
4	0	90	0	$\theta_4$
5	0	-90	0	$\theta_5$

$${}^uT = {}^uT_1 T_2 T_3 T_4 T_5 T \quad (7)$$

$${}^uT = \begin{bmatrix} r_{11} & r_{12} & r_{13} & p_x \\ r_{21} & r_{22} & r_{23} & p_y \\ r_{31} & r_{32} & r_{33} & p_z \\ 0 & 0 & 0 & 1 \end{bmatrix}$$

where

$$\begin{aligned} r_{11} &= [(c_1c_2c_3 - s_1s_3)c_4 - c_1s_2s_4]c_5 - (c_1c_2s_3 + s_1c_3)s_5, \\ r_{12} &= -[(c_1c_2c_3 - s_1s_3)c_4 - c_1s_2s_4]s_5 - (c_1c_2s_3 + s_1c_3)c_5, \\ r_{13} &= -(c_1c_2c_3 - s_1s_3)s_4 - c_1s_2c_4, \\ r_{21} &= [(s_1c_2c_3 + c_1s_3)c_4 - s_1s_2s_4]c_5 - (s_1c_2s_3 - c_1c_3)s_5, \\ r_{22} &= -[(s_1c_2c_3 + c_1s_3)c_4 - s_1s_2s_4]s_5 - (s_1c_2s_3 - c_1c_3)c_5, \\ r_{23} &= -(s_1c_2c_3 + c_1s_3)s_4 - s_1s_2c_4, \\ r_{31} &= (s_2c_3c_4 + c_2s_4)c_5 - s_2s_3s_5, \\ r_{32} &= -(s_2c_3c_4 + c_2s_4)s_5 - s_2s_3c_5, \\ r_{33} &= -s_2c_3s_4 + c_2c_4, \end{aligned}$$

$$p_x = -c_1s_2d_3 \quad (8)$$

$$p_y = -s_1s_2d_3 \quad (9)$$

$$p_z = c_2d_3 \quad (10)$$

$$\frac{p_x}{p_y} = \frac{-s_1s_2d_3}{-c_1s_2d_3} = \tan \theta_1$$

$$\theta_1 = A \tan 2(p_y, p_x) \quad (11)$$

$$\theta_2 = A \tan 2(\pm \sqrt{p_x^2 + p_y^2}, p_z) \quad (12)$$

$$\theta_3 = A \tan 2(s_1r_{13} - c_1r_{23}, -r_{13}c_1c_2 - s_1c_2r_{23} - s_2r_{33}) \quad (13)$$

$$\theta_4 = A \tan 2[-[(c_1c_2c_3 - s_1s_3)r_{13} + (s_1c_2c_3 + c_1s_3)r_{23} + (s_2c_3)r_{33}], (-c_1s_2r_{13} - s_1s_2r_{23} + c_2r_{33})] \quad (14)$$

$$\begin{aligned} \theta_5 &= A \tan 2[(-c_1c_2s_3 - s_1s_3)r_{13} + (-s_1s_3c_2 + c_1c_3)r_{21} + (-s_2s_3)r_{31}, \\ &\quad (-c_1c_2s_3 - s_1s_3)r_{12} + (-s_1s_3c_2 + c_1c_3)r_{22} + (-s_2s_3)r_{32}] \end{aligned} \quad (15)$$

$${}^5v_5 = {}^5R({}^4v_4 + {}^4w_4 \times {}^4p_5) \quad (16)$$

$$= \begin{bmatrix} (d_3 c_3 s_2 s_5 - d_3 c_4 c_5 s_2 s_3) \dot{\theta}_1 + (c_3 c_4 c_5 d_3 + s_3 s_5 d_3) \dot{\theta}_2 \\ (d_3 c_3 c_5 s_2 + d_3 c_4 s_2 s_3 s_5) \dot{\theta}_1 + (c_5 s_3 d_3 - s_5 c_3 c_4 d_3) \dot{\theta}_2 \\ d_3 s_2 s_3 s_4 \dot{\theta}_1 - s_4 c_3 d_3 \dot{\theta}_2 \end{bmatrix} \quad (17)$$

$${}^0 v_5 = {}^0 R^5 v_5 \quad (18)$$

$${}^u v_5 = \begin{bmatrix} r_{11} & r_{12} & r_{13} \\ r_{21} & r_{22} & r_{23} \\ r_{31} & r_{32} & r_{33} \end{bmatrix} \cdot {}^5 v_5 \quad (19)$$

where

$$\begin{aligned} r_{11} &= [(c_1 c_2 c_3 - s_1 s_3) c_4 - c_1 s_2 s_4] c_5 - (c_1 c_2 s_3 + s_1 c_3) s_5, \\ r_{12} &= -[(c_1 c_2 c_3 - s_1 s_3) c_4 - c_1 s_2 s_4] s_5 - (c_1 c_2 s_3 + s_1 c_3) c_5, \\ r_{13} &= -(c_1 c_2 c_3 - s_1 s_3) s_4 - c_1 s_2 c_4, \\ r_{21} &= [(s_1 c_2 c_3 + c_1 s_3) c_4 - s_1 s_2 s_4] c_5 - (s_1 c_2 s_3 - c_1 c_3) s_5, \\ r_{22} &= -[(s_1 c_2 c_3 + c_1 s_3) c_4 - s_1 s_2 s_4] s_5 - (s_1 c_2 s_3 - c_1 c_3) c_5, \\ r_{23} &= -(s_1 c_2 c_3 + c_1 s_3) s_4 - s_1 s_2 c_4, \\ r_{31} &= (s_2 c_3 c_4 + c_2 s_4) c_5 - s_2 s_3 s_5, \\ r_{32} &= -(s_2 c_3 c_4 + c_2 s_4) s_5 - s_2 s_3 c_5, \\ r_{33} &= -s_2 c_3 s_4 + c_2 c_4, \end{aligned}$$

$${}^0 v_5 = \begin{bmatrix} r_{11} & r_{12} & r_{13} \\ r_{21} & r_{22} & r_{23} \\ r_{31} & r_{32} & r_{33} \end{bmatrix} \begin{bmatrix} (d_3 c_3 s_2 s_5 - d_3 c_4 c_5 s_2 s_3) \dot{\theta}_1 + (c_3 c_4 c_5 d_3 + s_3 s_5 d_3) \dot{\theta}_2 \\ (d_3 c_3 c_5 s_2 + d_3 c_4 s_2 s_3 s_5) \dot{\theta}_1 + (c_5 s_3 d_3 - s_5 c_3 c_4 d_3) \dot{\theta}_2 \\ d_3 s_2 s_3 s_4 \dot{\theta}_1 - s_4 c_3 d_3 \dot{\theta}_2 \end{bmatrix} \quad (20)$$

Similarly the angular velocity of the manipulators and Jacobian are computed analytically, which are as follows:

$${}^0 w_5 = \begin{bmatrix} r_{11} & r_{12} & r_{13} \\ r_{21} & r_{22} & r_{23} \\ r_{31} & r_{32} & r_{33} \end{bmatrix} \begin{bmatrix} c_3 c_4 c_5 s_2 \dot{\theta}_1 - s_3 c_4 c_5 \dot{\theta}_2 + c_2 c_5 s_4 \dot{\theta}_1 + c_5 s_4 \dot{\theta}_3 + s_2 s_3 s_5 \dot{\theta}_1 + c_3 s_5 \dot{\theta}_2 - s_5 \dot{\theta}_4 \\ -c_3 c_4 s_2 s_5 \dot{\theta}_1 + s_3 s_5 c_4 \dot{\theta}_2 - c_2 s_4 s_5 \dot{\theta}_1 - s_4 s_5 \dot{\theta}_3 + c_5 s_2 s_3 \dot{\theta}_1 + c_3 c_5 \dot{\theta}_2 - c_5 \dot{\theta}_4 \\ -s_4 c_3 s_2 \dot{\theta}_1 + s_3 s_4 \dot{\theta}_2 + c_2 c_4 \dot{\theta}_1 + c_4 \dot{\theta}_3 + \dot{\theta}_5 \end{bmatrix} \quad (21)$$

The computed variables such as joint positions (equation (11) to (15)), Velocity and angular velocity of the joint are applied to the control system, which is discussed in the following section.

### C. Design of the Control System

The control system is developed based on the kinematics of the manipulators and the joint parameters  $\theta$ ,  $v$ ,  $w$ , and  $\tau$  are applied to the control system as shown in Figure 7. The equations (1) to (21) are used to compute the position, joint angle of each manipulator, velocity of the end-effectors, angular velocity of the joint and acceleration [6],[7].

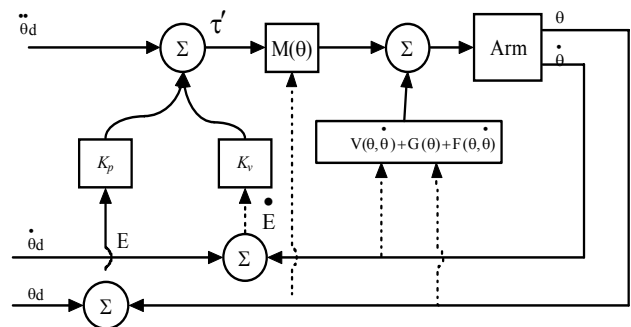

Fig. 7 Manipulators Control System

The model that is used to compute the torque is based on the rigid body dynamic equation [8], which is as follows:

$$\tau = M(\theta)\ddot{\theta} + V(\theta, \dot{\theta}) + G(\theta) \quad (22)$$

Where  $M(\theta)$  is the  $n \times n$  inertia matrix of the manipulator,

$V(\theta, \dot{\theta})$  is an  $n \times 1$  vector of centrifugal and Coriolis terms, and  $G(\theta)$  is an  $n \times 1$  vector of gravity terms. Each element of  $M(\theta)$  and  $G(\theta)$  is a complicated function that depends on  $\theta$ , the position of all the joints of the manipulator. Since the friction is the function of joint position and velocity, this will be incorporated in to the model and this will yield

$$\tau = M(\theta)\ddot{\theta} + V(\theta, \dot{\theta}) + G(\theta) + F(\theta, \dot{\theta}) \quad (23)$$

A partitioned control scheme is developed from the model shown in equation (23) and given as

$$\tau = \alpha \tau' + \beta \quad (24)$$

Where  $\tau$  is the  $n \times 1$  vector of joint torques and  $\alpha = M(\theta)$  and

$$\beta = V(\theta, \dot{\theta}) + G(\theta) + F(\theta, \dot{\theta}) \quad (25)$$

With the servo law

$$\tau' = \ddot{\theta}_d + K_v \dot{E} + K_p E \quad (26)$$

where  $E = \theta_d - \theta$

The resulting control system is shown in Fig. 7.

### III. SIMULATION

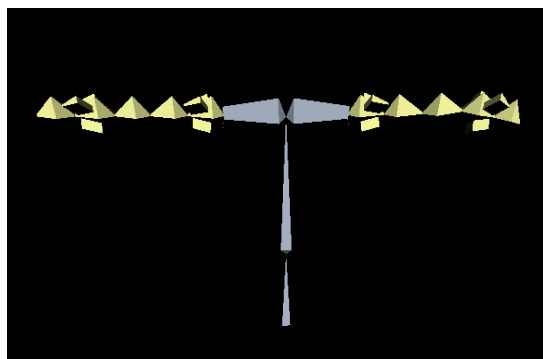

Fig. 8 Bone Structure of the Manipulators

Normally, in the design of the controller, a simulation will be in place such that the behavior of the designed controller could be analyzed. In view of supporting the development of a controller, a simulation of the manipulator is designed for Humanoid robot and shown in Fig. 8. This simulation is developed through the use of the Virtual Reality Toolbox and Simulink in Matlab. The Virtual Reality Toolbox in Matlab provides the interfacing and controls to an environment which is developed based on the Virtual Reality Modeling Language (VRML). Chains of bones were used to represent the robot as illustrated in Fig. 8.

To develop this bone structure would be rather troublesome by using a notepad to write the VRML codes. To avoid this time consuming task, Autodesk 3DS Max 8.0 was used to build the bone model. This model in 3DS Max is then exported into VRML.

Using the VRML editor in Matlab, V-Realm Builder, the model is customized. This is then followed by programming the block diagram in Simulink such that the user could control the bone structure shown in a VRML browser through the Matlab controls.

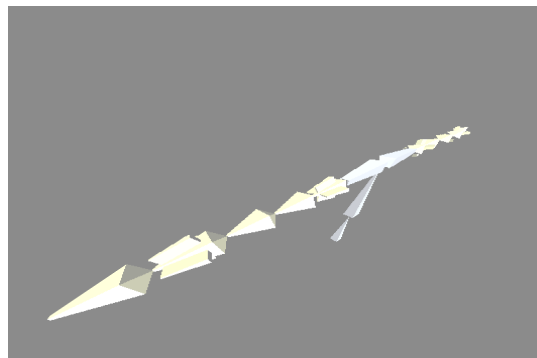

Fig. 9 Manipulators motion while simulation

To a further extend, the developed simulation could output the X, Y and Z position of the arm by using the derived Forward Kinematics. The developed simulation is as illustrated in Figs. 8 and 9 and the VRML block diagram is as shown in Figs. 10 and 11.

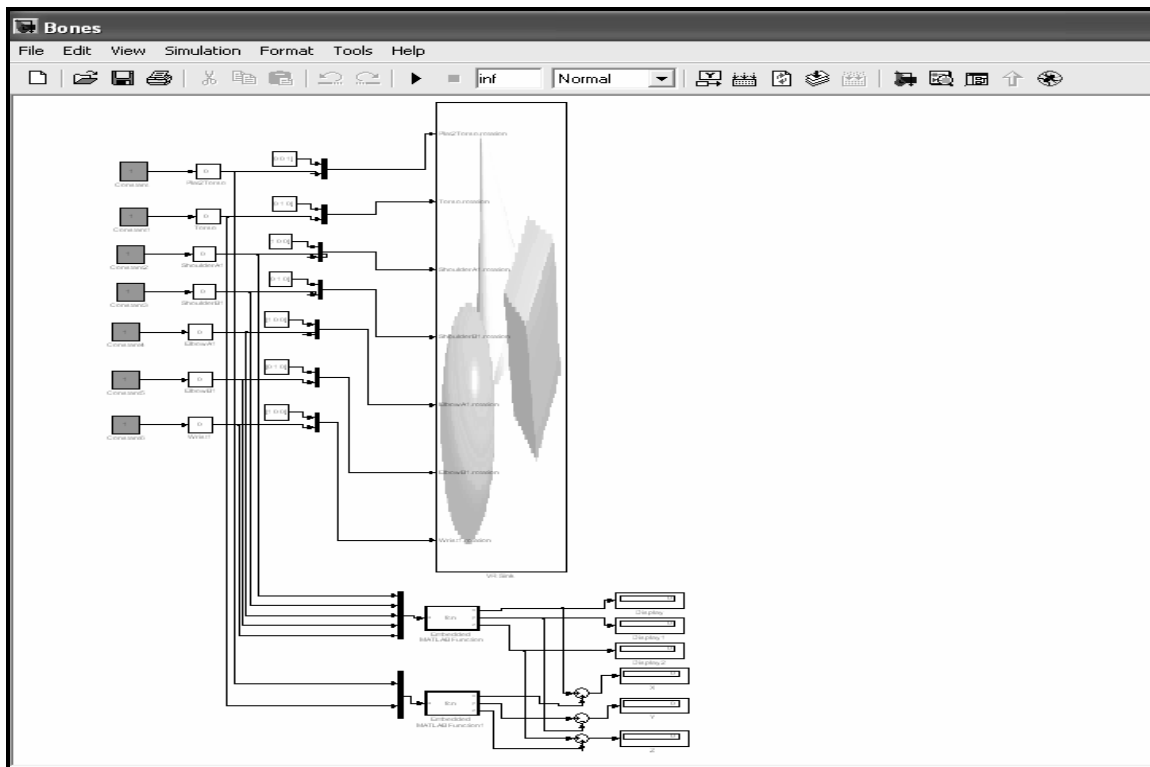

Fig. 10 Simulink Block Diagram

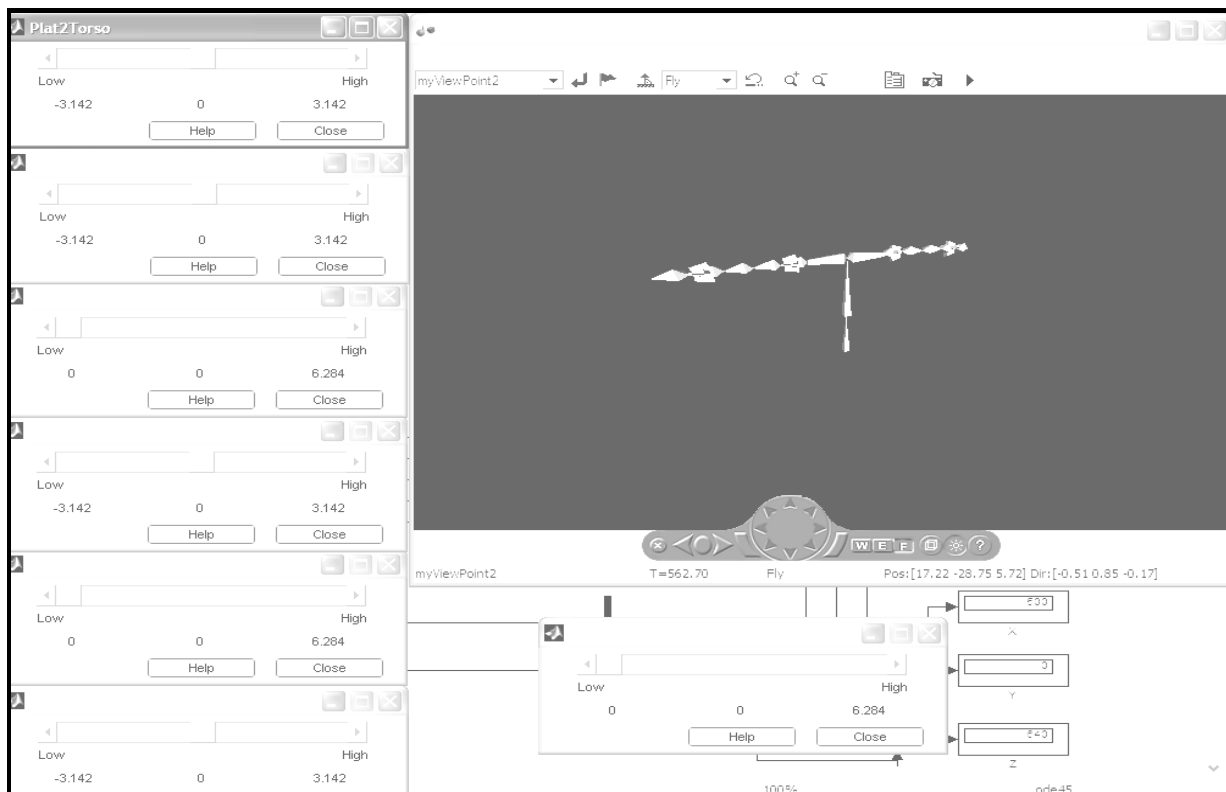

Fig. 11 Simulation of the Mobile Robot in a Bone Structure

#### IV. CONCLUSION

The analysis here is mostly valid from the waist to the end of the arm. All Parameters are computed using Matlab. Thus, if required, the analysis could be extended to the fingers easily when the frames are already assigned to the links of the fingers and the DH table derived. Looking into the final solutions, it would not be practical to illustrate these solutions here due to the length of the final solutions. In the development of the controllers, a simulation was developed in this work which could be used to observe how the robot behaves when the respective angles of the links are altered. To further extent, it could provide the user the X, Y and Z coordinates of the robot arm through the Forward Kinematics. Basically, there is still a lot of work which could be carried out in this project. With the use of Matlab, various controllers could be designed and tested using the developed simulation environment.

#### REFERENCES

- [1] Bischoff, R., *Design Concept and Realization of the Humanoid Service Robot HERMES*, <http://robotik.w3.rz.unibwmuennen.de/PDF/DeCoRo.pdf>
- [2] Craig, J. J., *Introduction to Robotics: Mechanics and Control, 2<sup>nd</sup> ed.*, Addison-Wesley, Reading, MA 1989.
- [3] Fukaya, N., Toyama, S., Asfour, T., Dillmann, R., *Design of the TUAT/Karlsruhe Humanoid Hand*. [http://www.sfb588.unikarlsruhe.de/publikationen/2000\\_16.pdf](http://www.sfb588.unikarlsruhe.de/publikationen/2000_16.pdf)
- [4] Graf, B., Helms, E., Lakshmana, V., Rohmoser, B., *Anthropomorphic Robot Assistants – Giving the Human a Helping Hand*. [http://www.morpha.de/download/publications/IPA\\_AnthropomorphicRobotAssistants\\_IEEE\\_RAS2002.pdf](http://www.morpha.de/download/publications/IPA_AnthropomorphicRobotAssistants_IEEE_RAS2002.pdf).
- [5] Nortman, S., Peach, J., Nechyba, M., Brown, L. S., Arroyo, A., *Construction and Kinematic Analysis of an Anthropomorphic Mobile Robot*. [http://www.mil.ufl.edu/publications/fcrar01/SDN\\_fcrar011.pdf](http://www.mil.ufl.edu/publications/fcrar01/SDN_fcrar011.pdf)
- [6] B.Markiewicz, "Analysis of the Computed Torque Drive Method and Comparison with Conventional Position Servo for a Computer-Controlled Manipulaors," Jet Propulsion Laboratory Technical Memo 33-601, March 1973.
- [7] J. La Salle and S. Lefschetz, *Stability by Liapunov's Direct Method with Applications*, Academic Press, New York, 1961.
- [8] P.K.Khosla, "Some Experimental Results on Model-Based Control Schemes," IEEE Conference on Robotics and Automation, Philadelphia, April 1988.
- [9] B. Armstrong, O. Khatib, and J. Burdick, "The Explicit Dynamic Model and Inertial Parameters of the PUMA560 arm," IEEE Conference on Robotics and Automation, San Francisco, April 1986.

**S. Parasuraman** has received a BE in Mechanical Engineering from the University of Madras, India and an ME in Manufacturing Automation from Anna University, India. He received a PhD in Mechanical Engineering (Robotics) from Monash University, Australia. He had worked in various capacities as Research and Development Engineer, Research and Development Manager, Lecturer and Senior Lecturer in various Industries in Malaysia and Monash University. His research interests are robotics, artificial intelligence, mobile robot navigation, sensors data fusion for mobile robots and robot kinematics, dynamics and controls.