

Blind Spot Area Tracking Solution using 1x12 POF-Based Optical Couplers

Mohammad Syuhaimi Ab-Rahman, Mohd Hadi Guna Safnal, Mohd Hazwan Harun,
Mohd. Saiful Dzulkefly Zan and Kasmiran Jumari

Abstract—Optical 1x12 fused-taper-twisted polymer optical fiber (POF) couplers has been fabricated by a perform technique. Characterization of the coupler which proposed to be used in passive night vision application to tracking a blind sport area was reported. During the development process of fused-taper-twisted POF couplers was carried out, red LED fully utilized to be injected into the couplers to test the quality of fabricated couplers. Some characterization parameters, such as optical output power, POFs attenuation characteristics and power losses on the network were observed. The maximum output power efficiency of the coupler is about 40%, but it can be improved gradually through experience and practice.

Keywords— polymer optical fiber (POF), customer-made, fused-taper-twisted fiber, optical coupler, small world communication, home network.

I. INTRODUCTION

IN the past few years, number of applications in automobile technologies based on optical fiber so rapidly developed as in the area of optical short-range communication. Demand POFs in application of automobile technology was relatively high [1,4,5,6]. POFs have attracted much attention in past decades especially in automobile field because POFs have some unique characteristics, such as flexibility, easy to handle, relative low cost in coupling due to their large core diameter [2], heat-proof, immune for noise (external electromagnet disruption), suitable for data communication for long distance up to 100 meter, high speed data transmission (400 Mbps for SI's type and 1 Gbps for GI's type), higher bandwidth (exceed 4 GHz) and have losses below 25 db / km additional loss once it bent [3,4,6,8]. In vehicles, airplanes and rail transportation more and more digital communications connections are being

utilized [5]. As a result, increased demands on the architecture of the data connections as well as the transmission media are being made [1].

Due to fact, that automobile field the step towards digitalization has long been made, POFs can meet many of these requirements to an optimum degree and are therefore increasingly of interest. Likewise, in the automotive technologies based on passive night vision, POFs can be applied to support these systems. Proposed study for passive night vision was defined by passive imaging system based on optical fiber sensor application. This sensor application was kind of technology based on optoelectronic and optical data communication through optical fiber. Optical fiber sensor gave more advantages compared with electronic sensor due to it quality, high sensitivity, high-speed data rate, low power budget, and low cost components required [7].

Optical imaging through optical fiber defined as a light transmitting system which being reflected by one of an end of optical fiber to another. This process will be successfully worked once a source of light applied on it, triggered the switching speed, with an appropriate wavelength and high optical output power. It is called passive system; they used the surrounding light as source to lighten up focused objects. In the context of automotive or driving, the particular invisible area by the driver either from forward direction or backward called blind spot area. Tracking over blind spot area focused on the behind part of vehicle, because while driving, the attention of the driver was more focused on forward area, and the eyesight range of behind vehicle was less.

Many research come out with their own proposed technology have been carried out, start from conventional side mirror (see Figure 1) until costly advanced ultrasonic sensor which put in the bumper part of vehicle. Although various methods were introduced to track blind spot area yet respectively has distinctive weakness. Therefore, further study need to be developed to solve the blind spot area tracking problem and overcome the weakness of previous methods.

Mohammad Syuhaimi Ab-Rahman, Mohd Hadi Guna Safnal, Mohd Hazwan Harun, Mohd. Saiful Dzulkefly Zan and Kasmiran Jumari Mohammad Syuhaimi Ab-Rahman are with the Computer and Network Security Research Group, Department of Electrical, Electronics and Systems Engineering, Faculty of Engineering and Built Environment, Universiti Kebangsaan Malaysia, 43600 UKM Bangi, Selangor, Malaysia (phone: +603-89216448; fax: +603-89216146; e-mail: syuhaimi@vlsi.eng.ukm.my, hadi_guna87@yahoo.com, parasit_911@yahoo.com, saiful@vlsi.eng.ukm.my and kbj@vlsi.eng.ukm.my).

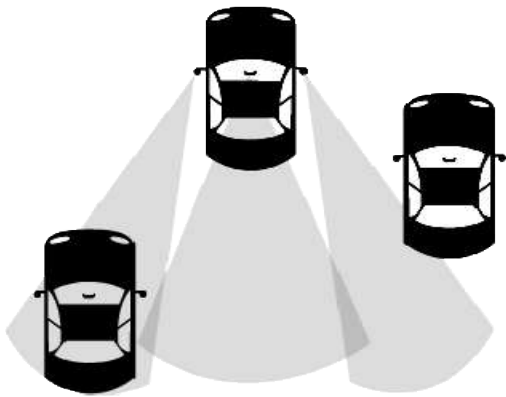

Figure 1. Blind spot area tracking with conventional side and rear-view mirror

Passive night vision with POF-based technology expected to be able to compete with other previous method to overcome the blind spot area tracking problem. Study for characteristics of POFs was strictly required to conduct for achieving desired design with some detail modification. In this case, the proposed fabrication design finally comes out with a real fused-taper-twisted POF coupler (see Figure 2).

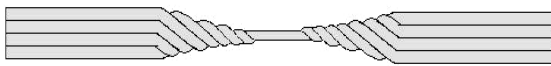

Figure 2. Fabrication of fused-taper-twisted POF

In this study, as a preliminary work on the investigation of prototype characterization, it also carried out to develop the design of end part of fused-taper-twisted POF coupler. In prototype characterization, some experiments were conducted to determine optical output power, POFs attenuation characteristics and power losses on the network.

II. EXPERIMENTAL

POF-based coupler is an optical device which ended by 12 port as an input, while the other side ended by 1 output port. Furthermore, they both work bidirectional. However, they can work from the 1 port into 12 port or vice versa, for passive night vision application we need to apply coupler function which operated from 12 POF combined into 1 POF port, based on the objective of the research to ensure 12 separate optical signals to be linked into one coupled signal, as a centralized monitoring concept to overcome blind spot problem.

A. Material

In development process of 1x12 coupler based on POF technology, multimode SI-POF type made of polymethyl methacrylate (PMMA) 1 mm core size fully utilized in this paper, as PMMA is one of the most commonly used optical materials, Due to its intrinsic absorption loss mainly contributed by carbon-hydrogen stretching vibration in PMMA core POF [6].

B. Prototype Development

By overall, prototype development gives a priority in fabrication method due to expectation to generate an optical coupler with the specifications which meet research's requirement. Development process for the proposed technology can be seen in Figure 3.

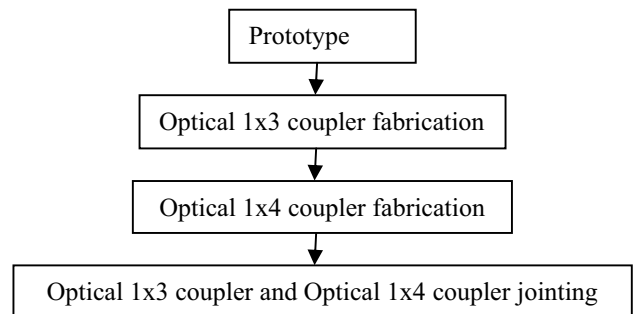

Figure 3. Flowchart for prototype development process.

C. Prototype design

In this study, optical 1x12 coupler developed by the jointing of Optical 1x3 coupler and Optical 1x4 (both devices fabricated based on fused-taper-twisted POF). Other specification for the design, the 1x12 coupler reach data transmission distance up to 25 cm. therefore, a POF cables (11 to 13 cm length) is required to be linked with end part of 1x3 coupler (as an output) to input of 1x4 coupler. Basically, this optical 1x12 coupler design (see Figure 4) formed by all four optical 1x3 couplers arranged in series, and this series arrangement connected with optical 1x4 couplers parallel.

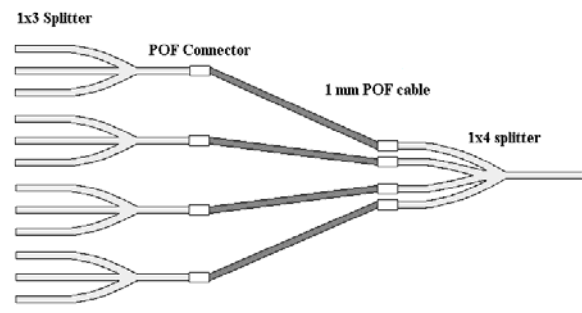

Figure 4. Optical 1x12 coupler design for passive night vision application

D. Fabrication method

To fabricate the final product of optical 1x12 coupler, some stages has to be done, start from fiber fusion, bundle formation and finalized with cable jointing.

Fusion method either for optical 1x3 or 1x4 coupler has just the same principle. Fabricated through fusion method by fuses and combine 3 or 4 POFs (in bundle form) and fabricate it ends part in a shape of fused-taper-twisted fibers (diameter 1 mm). POFs will be twisted and pulled down while it is fused

in a heat of flame. Heating process was done indirectly, while POFs covered by metal tube. Thus, heat was provided for POFs through metal tube heating (see Figure 5).

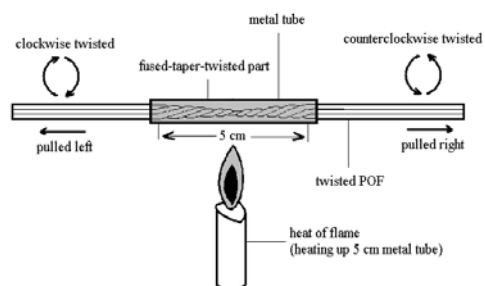
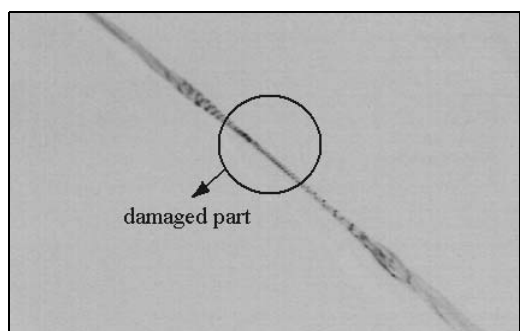

Figure 5. Fabrication method of POFs

Right after twisted closely of POF's center part obtained, metal tube will be heated up until center part starting to melt. Then, gently pull the POFs in opposite directions, until the shape of that part properly taper-twisted. However, some of the POFs successfully fabricated before, some damaged samples still found from the fabrication aspects of it, e.g. imperfect shape. A sample can be called ideal once its diameter uniformly fused-taper-twisted approaching 1 mm. To confirm that samples unable to be used in characterization testing, these samples will be tested by red-LED injection. It is obtained that red-LED will not come out from the samples in a bad quality. Thus, the samples cannot be used in characterization testing (see Figure 6(a) & 6(b)).



(a)



(b)

Figure 6. Final product of fused-taper-twisted POFs (a) meet the specification's requirement (b) with damaged formation

To connect optical 1x3 and 1x4 coupler, research suggests using 1 mm POFs cable. Connection between 1x3 couplers and POFs cable joint by POFs connector (1 mm core diameter with jacket). POF connector contains two different socket sides, the one with a wide socket pit while the other has a narrower. The end part of 1x3 taper-twisted POFs is inserted into the socket with a wider slot and glued properly, so that the connection will be difficult to be pulled out. While the other slot side of the connector is inserted by POFs cable (see Figure 7).

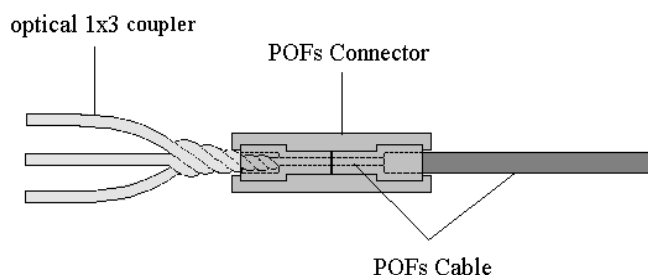

Figure 7. Connection between optical 1x3 coupler with 1 mm POF cable

After successfully linking the optical 1x3 coupler with one side of POFs cable, the fabrication method continues by connecting the other side of POFs cable with an optical 1x4 coupler using the same method explained before (see Figure 8).

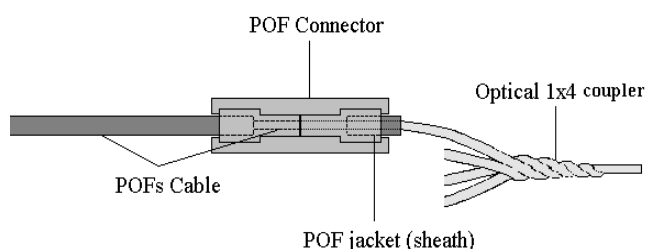

Figure 8. Connection between 1x4 coupler with 1 mm POF cable

E. Prototype characterization

In this study, characterization needs to be carried out for each fabricated optical coupler. Each of the developed couplers must be able to couple every optical signal to generate one coupled optical signal with low power loss.

In this study, an optical power meter has been used to measure the optical power from POFs. Before the switch is opened, it is obtained that $0.02\mu\text{W}$ for its zero error exists on the meter. It is stated that $11\mu\text{W}$ optical power of a red LED was injected as an optical input power for each POF.

The best sample from the fabrication process has been chosen. Ideally, once the input power starts being injected into an optical 1x12 coupler, the output and input will be the same. If we inject 1 end-POF with $11\mu\text{W}$ optical power, then the other end side of 12 POFs could reach $\sim 1\mu\text{W}$ of output power for each POF.

III. RESULT AND DISCUSSION

The analysis of the prototype characterization was carried out, especially for its efficiency percentage of each POFs. So, the comparison for the all power efficiency of optical 1x12 coupler based on POFs has been observed, which the 1 end-POF act as an input and the other side which consist of 12 POFs stated as an output, the comparison between input and output has been calculated (see Figure 9).

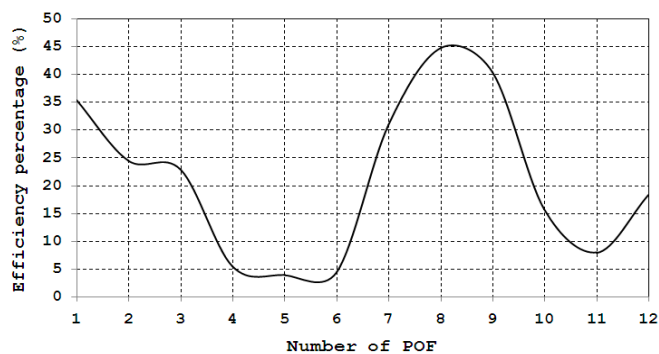
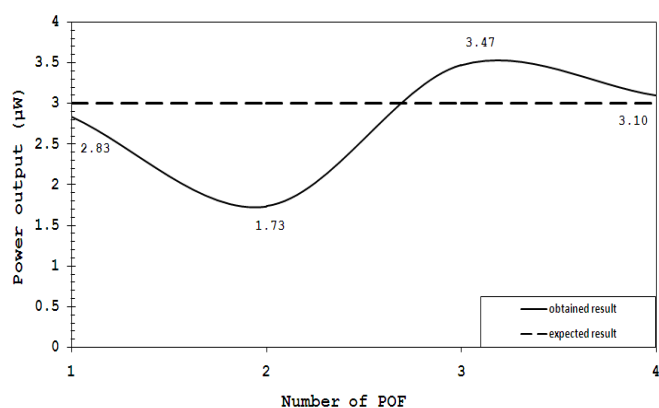

Figure 9. Comparison of each POF (came from the end side of 12POFs) which has been injected with $11\mu\text{W}$ from the input side (1POF), in this case, maximum efficiency of optical 1x12 coupler can be reach up to 40%

From the observation above, the power efficiency of each output shows a different value with a maximum power efficiency reaching 40%. It is true; because error could be happen on it either while fabrication process or characterization test stages imposed on them.

Measurement also conducted in optical 1x4 couplers using optical power meter with $12\mu\text{W}$ injected into the 1POF as an input and 4POF as an output. As expected, output will be obtained minimum is $3\mu\text{W}$ (as the power was separated into 4POFs). The result can be seen in Figure 10.

Figure 10. Obtained power output compared with expected result



Irregularities of controlled heat while heating process exposed on the POFs become one of the major problem, due to its lower melting point makes core structure of POF could be more sensitive on heating process. Once it is damaged, it is hard to let a light pass through the core, or even not pass at all.

IV. CONCLUSION

In summary, a perform technique has been used to fabricate optical 1x12 coupler with based on POFs technology. Multimode SI-POF type with 1 mm core size fully utilized for the base material of the coupler. Some procedures, such as fabrication and characterization stages have been carried out to develop the coupler. Red LED with a 650 nm wavelength has been injected into the coupler for the purpose of characterization testing to analyze the level of power efficiency of the coupler. Final analysis shows that efficiency of coupler output able to reach up to 40%.

This POF-based optical 1x12 coupler have been suggested to be applied into automobile application to overcome blind spot area tracking problem as a one of low-cost solution in the future. As advised, POF sensor will be connected with optical 1x12 coupler, in this case the coupler will be act like an optical network which has a function to coupling the optical signal (blind spot area image) from all of installed POF to become one coupled signals (12x1) to be sent into POF transeiver (for optical signal processing). It is recommended to install all of 12 POF sensors into the bumper back side of vehicle, in order to obtained wider imaging (blind spot) area.

Further study about interfacing POF-based system for the automobile application are advised to be conducted, all the way to improve the efficiency of POFs power transmission, in order to overcome blind spot area tracking problem with passive night vision application.

ACKNOWLEDGMENT

The research activity had been conducted in Photonic Technology Laboratory, Institute of Micro Engineering and Nanoelectronics (IMEN), Universiti Kebangsaan Malaysia (UKM). The authors would like to thank Prof. Dr. Sahbudin Shaari for his invaluable help in model development and simulation prior to this work. This work was supported by the Malaysian Ministry of Science, Technology and Innovation (MOSTI) under Research University Grant UKM-GUP-TMK-07-02-108.

REFERENCES

- [1] A. Grzemba. MOST: The Automotive Multimedia Network. Franzis, Kevelaer: Germany, 2008.
- [2] E. Nihei, S. Shimizu, Opt. Commun. 275 (2007) 14–21.
- [3] H. Y. Liu, H. B. Liu, G. D. Peng, P. L. Chu, Opt. Commun. 220 (2003) 337–343.
- [4] M. G. Kuzyk. Polymer Fiber Optics: Materials, Physics, and Applications. Taylor & Francis Group, Boca Raton: USA, 2007.
- [5] O. Zieemann, J. Krauser, P. E. Zamzow, and W. Daum, POF Handbook: Optical Short Range Transmission Systems, 2nd. Springer, Berlin: Germany, 2008.
- [6] R. J. Yu, B. Zhang, M. Chen, L. Huo, Z. Tian, X. Bai, Opt. Commun. 266 (2006) 536–540.
- [7] Y. Zhang, G. R. Pickrell, B. Qi, A. S. Jazi, and A. Wang, Sensors. 6, pp. 823–834, 2006.
- [8] X. Xu, Opt. Commun. 225 (2003) 55–59.



Mohammad Syuhaimi Ab-Rahman received the B.Eng., M.Sc. and PhD degrees in Electrical, Electronics and Systems Engineering from Universiti Kebangsaan Malaysia (UKM), Malaysia, in 2000, 2003, 2007 respectively.

He joined the Institute of Micro Engineering and Nanoelectronics (IMEN) in 2003. He is currently a senior lecturer in UKM, Malaysia. He is also an associated research fellow of IMEN since 2006. His current research interests are in the area of photonic networks and optical communication technologies such as optical security nodes, device fabrication, photonic crystal, laser technology, active night vision, plastic optical fiber, fiber to the home, fiber in automotive and optical code-division multiplexing (OCDM). The current and interest project is development of survivability and smart network system for customer access network then can be called as an intelligent Fiber-to-the-Home (*i*-FTTH), collaborated with Ministry of Science, Technology and Innovation (MOSTI) of the Government of Malaysia.



Mohd Hadi Guna Safnal graduated from UKM with a B.Eng. in Electrical, Electronics and Systems Engineering. In July 2008, he joined as a researcher in the Computer and Network Security Research Group, UKM. Currently, he is doing a M.Sc. degree in Electrical, Electronics and Systems Engineering at the Faculty of Engineering and Built Environment, UKM. His current research interests are in the area of optical communication, FTTH network and polymer optical fiber technologies.



Mohd Hazwan Harun graduated from UKM with a B.Eng. in Microelectronics Engineering. In July 2008, he joined as a researcher in the Computer and Network Security Research Group, UKM. Currently, he is doing a M.Sc. degree in Electrical, Electronics and Systems Engineering at the Faculty of Engineering and Built Environment, UKM. His current research interests are in the area of polymer optical fiber technology.



Mohd Saiful Dzulkefly Zan obtained BEng from Waseda University, Japan in 2006. He has been appointed as assistant lecturer in Universiti Kebangsaan Malaysia since 2007. The current and interest is in the field of photonic technology, fiber optic communication and optical devices.



Kasmiran Jumari is a professor in the Department of Electrical, Electronics and Systems Engineering, UKM. He received the B.Sc. and M.Sc. in Physics and Instrument Design from UKM and University of Aberdeen in 1976 and 1978, respectively. In 1985, he holds a PhD degree in Electronics from University of Kent.

His research is in the area of security system, intrusion detection system, signal processing, image processing and computer communications networks. Currently, he is also hold a position as an associate research fellow of Institute of Space Science (ANGKASA).