

Optimization of the Transfer Molding Process by Implementation of Online Monitoring Techniques for Electronic Packages

Burcu Kaya, Jan-Martin Kaiser, Karl-Friedrich Becker, Tanja Braun, Klaus-Dieter Lang

Abstract—Quality of the molded packages is strongly influenced by the process parameters of the transfer molding. To achieve a better package quality and a stable transfer molding process, it is necessary to understand the influence of the process parameters on the package quality. This work aims to comprehend the relationship between the process parameters, and to identify the optimum process parameters for the transfer molding process in order to achieve less voids and wire sweep. To achieve this, a DoE is executed for process optimization and a regression analysis is carried out. A systematic approach is represented to generate models which enable an estimation of the number of voids and wire sweep. Validation experiments are conducted to verify the model and the results are presented.

Keywords—Epoxy molding compounds, optimization, regression analysis, transfer molding process, voids, wire sweep.

I. INTRODUCTION

TRANSFER molding process is a well-established process for encapsulation of electronic packages, e.g. for power modules due to its cost-efficiency and high production volume. Usually epoxy molding compounds (EMC) are used as a packaging material due to the fact that they have a good thermo-mechanical matching to materials typically used in packaging and thermal stability. Final package quality strongly depends on the process parameters of the transfer molding process and the material characteristics of EMC. Although transfer molding process is a major process for encapsulation of electronic packages, there are several challenges regarding the process. Firstly, the optimum process parameters for the transfer molding process are often not easily obtained and the parameter settings are done mostly in a trial and error manner [1], [2]. Furthermore, the machine settings are mostly not reflecting the situation in the cavity. The pressure and temperature set in the machine are deviating from pressure and temperature measured in the cavity. Yet, some failure mechanisms can arise during transfer molding process, which can cause a total package failure. Void formation, wire sweep, or delamination are some of the common failure mechanisms, which can occur in the package.

In order to diminish the failure mechanisms in the package and to increase the quality of the package, understanding impact of the process parameters on the package quality is necessary. Additionally, online monitoring techniques are required in order to monitor the process parameters and to obtain a stable

transfer molding process.

In our previous work, the influence of the process parameters on the voids and wire sweep were investigated [3]. OFAT (one factor at a time) design was selected to analyze the impact of each process parameter on the number of voids and degree of wire sweep. In addition, the suitability of the demonstrator layout for the DoE was tested.

This work aims to develop a systematic approach to generate a model which describes the correlation between process parameters and package quality. D-optimal design was selected to study the interaction between the process parameters, and to generate a qualified process model. This process model is introduced for an estimation of the package quality. To validate the process model, additional experiments were conducted and the results obtained from these validation experiments were compared with the results predicted with the model. In order to monitor process stability, additional temperature and pressure sensors were implemented into the cavities.

II. EXPERIMENTAL

As an encapsulation material, highly filled EMC containing a filler content of approx. 83 % by weight of molding compound was used in this work. Cut off size of the filler particles was around 75 μm .

As process parameters, temperature (T), holding pressure (P), preheat time (t) and transfer speed (v) were studied. D-optimal design was selected as a DoE to include the interactions between the process parameters and the quadratic influences of parameters into the model. The process parameters set in 3 levels, and in total 20 different parameter combinations were studied. Each parameter set was run five times to obtain repeatable results. Table I shows the experimental plan executed in this work.

The experiments were conducted with a Lauffer transfer molding press (clamping force of max. 280 kN) in a tool with two cavities. A vacuum system was implemented into the tool to avoid air entrapments in the package. To monitor process stability and to measure temperature and pressure in the cavities, eight additional temperature and pressure sensors were mounted into the cavities (Kistler Instrumente GmbH) (Fig. 1).

Burcu Kaya is with the Robert Bosch GmbH, Germany (corresponding author; phone: 004971181112133; e-mail: burcu.kaya2@de.bosch.com).

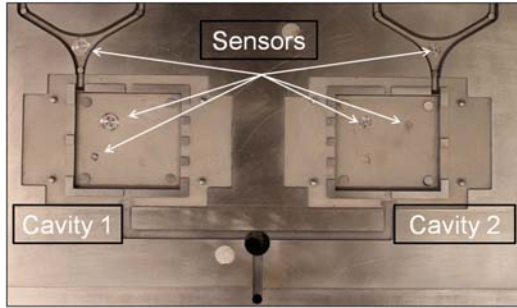

Fig. 1 Molding tool with two cavities with mounted temperature and pressure sensors

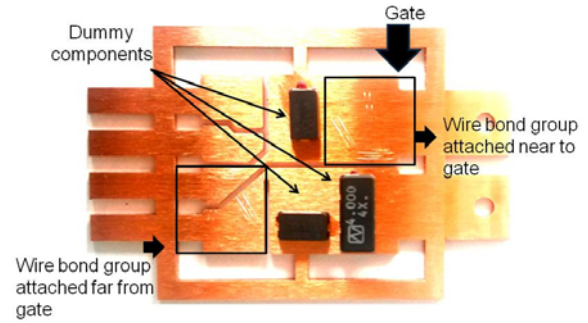

Fig. 2 Layout of the demonstrator with 24 wire bonds in different positions and location relative to the gate and 3 dummy components

As a criterion for the failure mechanics, the goal is to achieve void-free packages, and acceptably low wire deformation, i.e. maximum lateral displacement of the wire bond should not exceed 10% of its span [3].

TABLE I
 EXPERIMENTAL PLAN

Parameter set no.	T (°C)	v (mm/s)	P (bar)	t (s)
1	165	6.5	80	0
2	165	6.5	140	16
3	165	1.5	80	0
4	165	1.5	80	16
5	165	1.5	140	0
6	165	4	110	8
7	175	6.5	110	0
8	175	4	80	0
9	175	6.5	80	8
10	175	1.5	110	16
11	175	1.5	140	0
12	175	4	110	8
13	185	1.5	80	16
14	185	1.5	140	16
15	185	6.5	80	16
16	185	1.5	140	0
17	185	6.5	140	0
18	185	6.5	80	0
19	185	4	140	16
20	185	4	110	0

T= temperature, v=transfer speed, P=holding pressure, t=preheat time

To study the wire sweep, overall 24 aluminum wire bonds with a thickness of 50 μm were bonded on the demonstrator substrate. To analyze the influence of the wire bonds positions on the wire sweep, the wire bonds were attached close to the gate as well as far from the gate. Both positions consisted wire bond groups in three different angles to the gate, i.e. 180°, 90°, and 45°. To study the influence of the wire bond length on the wire deformation, short (2.7 mm) and long wire bonds (5.5 mm) with identical loop height (0.5 mm) were bonded in each group. Moreover, three dummy components with two different sizes were implemented onto the substrate (FRG Frischer Electronic GmbH). The layout of the demonstrator is illustrated in Fig. 2.

Visual inspection was employed to analyze the wire bonds. To inspect the wire bonds after the molding process, the molded package was opened by laser etching techniques, and the wire bonds were analyzed. Each wire bond was examined before and after the molding process and the difference between initial and final wire positions was determined (Fig. 3).

The void formation was detected by a scanning acoustic microscope (SAM) with a transducer frequency of 15 MHz.

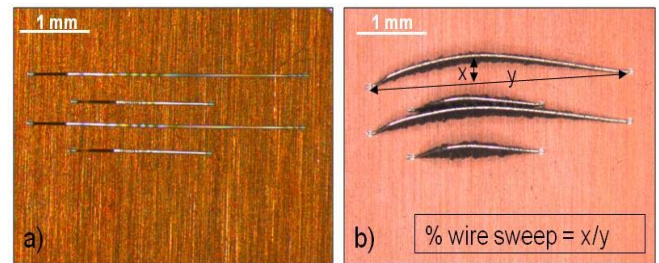

Fig. 3 Measurement of the wire sweep (a) before the molding process (b) after the molding process

Regression analysis was used in this work to correlate the process parameters with voids and wire sweep and to identify the significant process parameters and the interaction between the parameters. After the evaluation of wire sweep and void presence, models were introduced which describe the relationship between process parameters and quality characteristics (Fig. 4) For each quality characteristics, a separate model was introduced so that the model accuracy is high enough to predict the quality characteristics precisely.

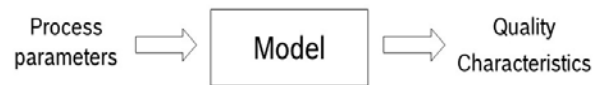

Fig. 4 The general definition of model

Additional experiments were conducted to validate the process model. To compare the results with DoE and to ensure process stability, three known parameter combinations which were already run in the DoE were repeated in the validation experiments. In addition, four new parameter combinations were integrated into the experimental plan to test the model with unknown process parameter combinations. The experimental plan for the validation experiments is illustrated in Table II.

TABLE II
EXPERIMENTAL PLAN FOR VALIDATION

Parameter set no.	T (°C)	v (mm/s)	P (bar)	t (s)
1	165	6.5	80	0
2	168	2	80	2
3	168	5	100	4
4	175	4	110	8
5	177	2	85	12
6	182	1.5	140	0
7	185	1.5	80	16

III. RESULTS AND DISCUSSION

Fig. 5 demonstrates the void formation with respect to different processing parameters. The number of voids was significantly influenced by the process parameters. Depending on the parameter combination, with some processing parameters e.g. parameter set no. 2, 6, 12, 17, low void formation was observed in the package, whereas with some processing parameters e.g. parameter set no. 13, many voids were formed in the package (Fig. 6 (a)).

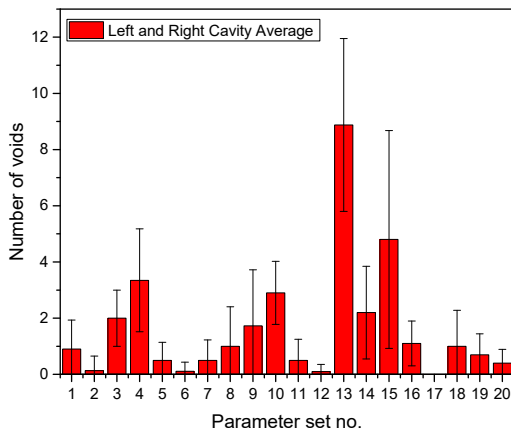

Fig. 5 Influence of process parameters on void formation

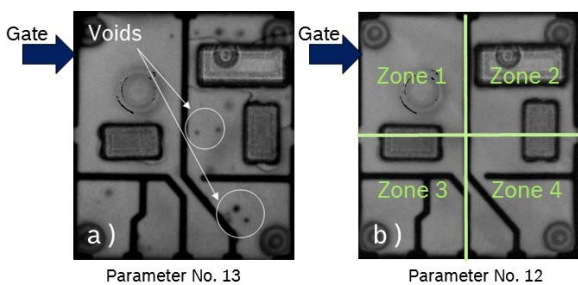

Fig. 6 SAM images of the molding packages (a) voids in the package for parameter set no.13 (b) voids formed in different zones in the package

As seen in Fig. 6 the voids were formed in different positions in the package. Identification of the positions of the voids in the package is important to define the critical areas on the layout.

For this reason, the voids were divided into four different zones as illustrated in Fig. 6 (b). The number of voids formed in different zones is given in Fig. 7.

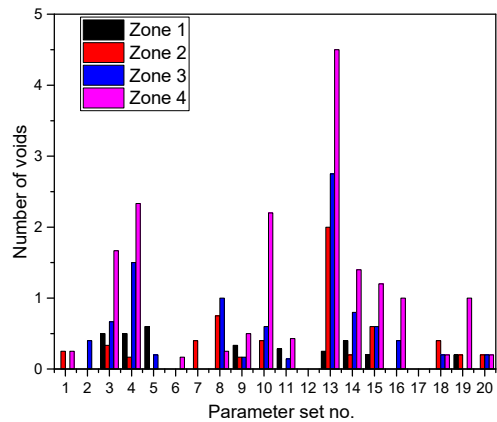

Fig. 7 Void formation in different zones with respect to process parameters

Regression analysis was used to determine the significant process parameters on the void formation. Fig. 8 indicates the influence of the process parameters on the number of voids. Hereby, on the y-axis in Fig. 8 “adjusted” number of voids is shown. In regression analysis, adjusted number of voids are simply the values, in which the other influencing factors are eliminated, so that only the impact of one factor i.e. one process parameter, on the number of voids is investigated [5]. Holding pressure and transfer speed showed significant influence on the void formation. By increasing holding pressure and transfer speed, the number of voids decreased substantially. On the other hand, temperature and preheat time did not show a strong influence on the void formation. Decreasing preheat time and temperature showed only a low impact on the diminishing of the number of voids.

The influence of process parameters on wire sweep is presented in Fig. 9. Wire sweep was influenced notably by the process parameters. Depending on the process parameters set, wire deformation was varied in the package. Wire bonds attached close to the gate showed more deformation compared to wire bonds attached far from the gate.

The influence of the process parameters on the short wire bond is demonstrated in Fig. 10. It is evident that the short wire bonds did not show large wire deformation. Only in some process parameter combinations i.e. parameter set no. 2, large wire deformation was observed for short wire bonds. Nevertheless, short wire bonds attached close to the gate showed larger deformation compared to the short wire bonds attached far from the gate. Generally, the long wire bonds demonstrated larger wire sweep in comparison to the short wire bonds.

Adjusted Response Graph for Voids

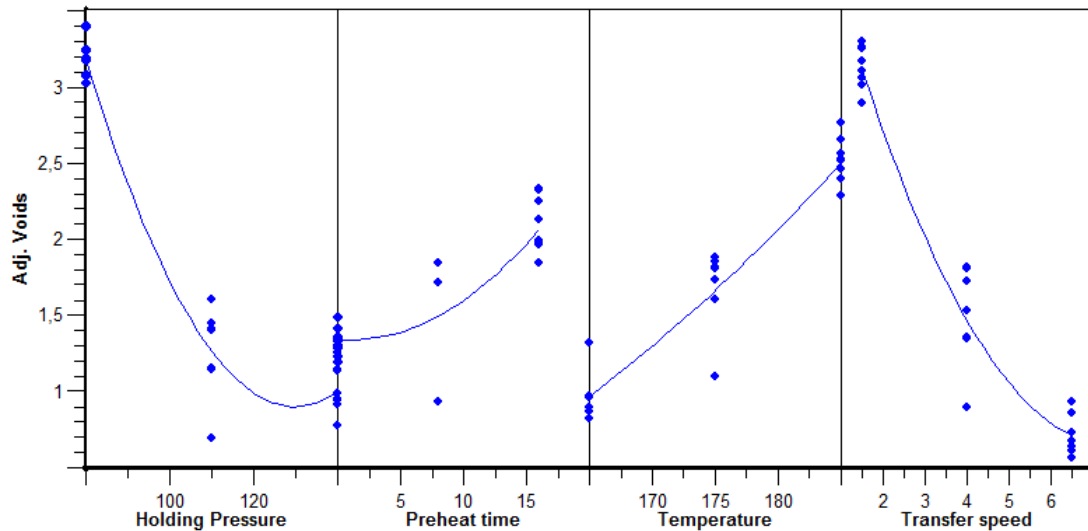

Fig. 8 Significant process parameters on the void formation

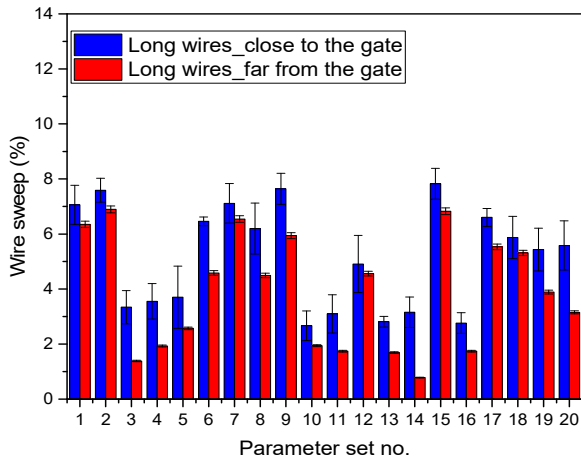

Fig. 9 Influence of process parameters on long wire bonds located close to the gate and far from the gate

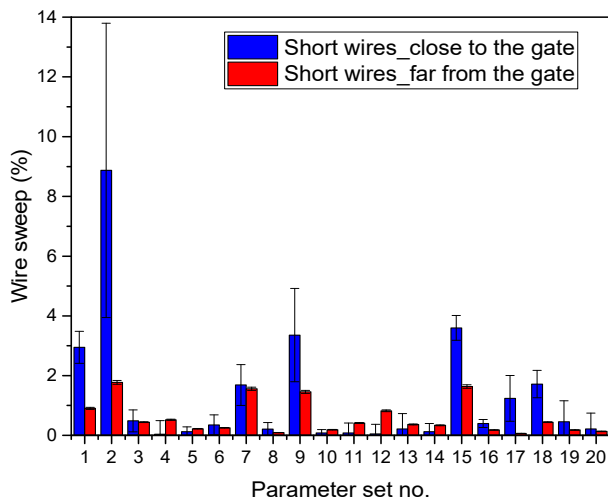

Fig. 10 Influence of process parameters on short wire bonds located close to the gate and far from the gate

In Fig. 11, the influence of the direction of the wire bonds to the gate on the wire sweep is shown. Only slight differences on the wire sweep were observed for different angles of wire bonds. The tendency of the wire deformation regarding different parameter combinations was similar in all wire bond directions.

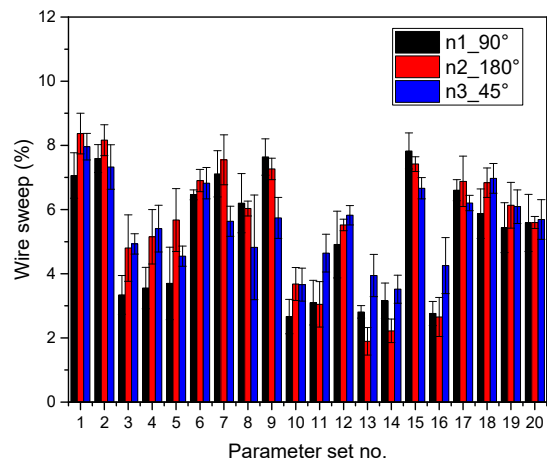

Fig. 11 Influence of process parameters on the wire bonds with different angles to the gate

The significance of different process parameters for wire sweep is represented in Fig. 12. The regression analysis showed, that the transfer speed had a remarkable influence on the wire sweep. On the contrary to the effect observed in void formation, transfer speed showed a negative influence on the wire sweep. By increasing the transfer speed, the wire deformation increased. This effect caused mostly due to the fact that by increasing the transfer speed, the force applied on the wire bonds raised. Moreover, temperature showed slight influence on the wire sweep, and by increasing the temperature, the wire deformation diminished. Preheat time and holding

pressure showed minor impact on the wire sweep.

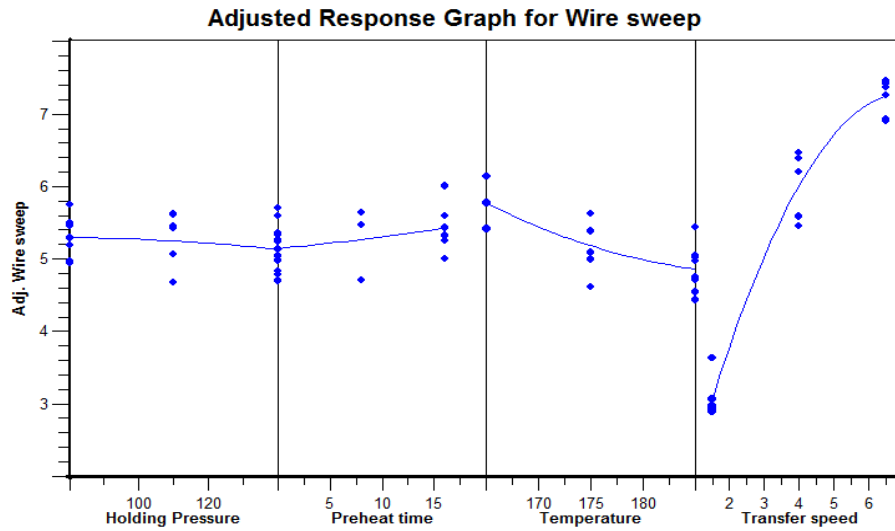

Fig. 12 Significant process parameters for wire sweep

After evaluating the significant process parameters, it is possible to determine the optimum process parameters for a minimum number of voids and a minimum wire sweep. Table III illustrates optimum process parameters. To achieve best package quality with the lowest number of voids and the smallest wire deformation, higher holding pressure, slower transfer speed, medium temperature and short preheat time are required.

TABLE III

OPTIMUM PROCESS PARAMETERS FOR VOIDS AND WIRE SWEEP

Process Parameters	Optimum Process Parameters
Holding Pressure	138 bar
Preheat time	4 s
Temperature	171 °C
Transfer speed	1.5 mm/s

Subsequently, the models for the estimation of the number of voids and wire sweep were generated. A quadratic model which includes all two factors interactions and the quadratic terms was selected. An example of a quadratic model for two factors is shown in (1) where; x_1 and x_2 are the factors, $\beta_1, \beta_2, \dots, \beta_n$ are the coefficients, β_0 is the constant, and ε_i is the residual [5]. Two separate models were described for the estimation of number of the voids and wire sweep respectively.

$$y_i = \beta_0 + \beta_1 x_{1i} + \beta_2 x_{2i} + \beta_{11} x_{1i}^2 + \beta_{12} x_{1i} x_{2i} + \beta_{22} x_{2i}^2 + \varepsilon_i \quad (1)$$

Table IV demonstrates the R^2_{adj} (adjusted coefficient of determination), which indicates the fitting quality of the model and RMS (root mean squared) error, which is an estimation of the difference between measured output parameters, i.e. number of voids and wire sweep and the values predicted with the model [4].

TABLE IV
 FITTING QUALITY OF THE REGRESSION MODELS

Quality characteristics	R^2_{adj}	RMS-Error
Voids	0.97	0.35
Wire sweep	0.95	0.42

Table IV shows that over 97% of the voids formed and 95% of the wire deformation that occurred in the package can be explained with the help of this model. The RMS errors are relatively small for both models, which enable accurate predictions. Thus, the results imply that the process parameters correlate well with number of the voids and wire sweep and this correlation can be described with this mathematical model.

The models were validated with the additional experiments. Firstly, the process stability was tested by running the three known processing parameters which were already evaluated in the DoE. The results for the number of voids and for the wire sweep were compared and found similar to the results obtained from the DoE which assures that the process was stable. The estimation of the number of voids was done for seven processing parameters (Table II) by using the regression models and the results of the estimation for number of voids and the wire sweep are shown in Table V.

TABLE V
 PREDICTION OF NUMBER OF VOIDS AND WIRE SWEEP WITH MODEL

Parameter set no.	Predicted number of voids	Predicted wire sweep (%)
1	1	7.4
2	3	4.2
3	0	6.9
4	1	6
5	6	3.8
6	1	3.0
7	11	2.7

Fig. 13 demonstrates the comparison of the number of voids predicted by model with the number of voids measured in validation experiments. The number of voids calculated with the model was found very close to the number of voids measured in validation experiments. Moreover, the model also delivered very promising results for the unknown processing parameters i.e. parameter set no 2, 3, 5, 6.

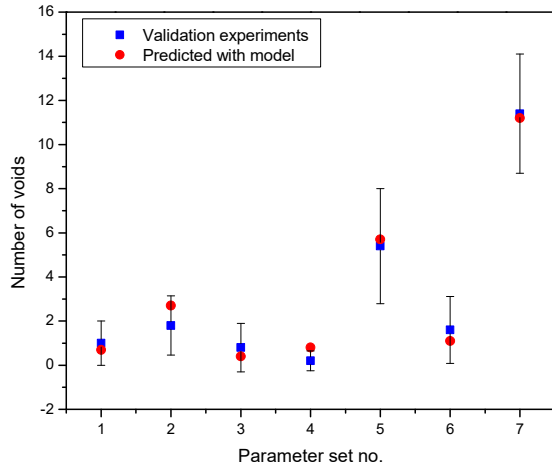

Fig. 13 Comparison of the voids results obtained from the validation experiments with the results estimated with the regression model

The similar approach was used also to test the regression model for wire sweep. The results obtained from the validation experiments were compared with the results calculated with the model. The comparison between model results and validation results is illustrated in Fig. 14.

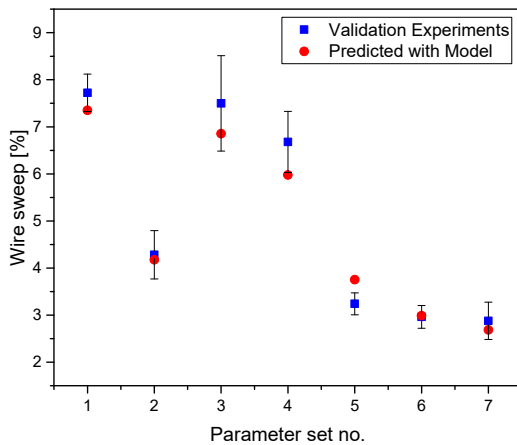

Fig. 14 Comparison of wire sweep results obtained from validation experiments with results estimated with the regression model

As seen in Fig. 14, the wire sweep analyzed with the validation experiments showed very similar results to the wire sweep calculated with the model. Yet, considering the voids and wire sweep results, it is possible to say that the regression model for both quality characteristics delivered very promising results and the models worked good for an estimation of the number of voids and wire sweep in the molded packages.

IV. CONCLUSIONS

In this study, a systematic approach is presented to define the relationship between the process parameters and the quality characteristics. Models were defined which allow an estimation of the number of voids and the wire sweep.

The results of void formation showed that the number of voids was strongly affected by the process parameters. The number of voids was divided into four zones to identify the critical zone on the layout. Zone 4, far from the gate, was found to be a critical zone, where the majority of voids were formed. Holding pressure and transfer speed were selected as significant process parameters for void formation. Increasing holding pressure and transfer speed diminished the number of voids in the package. On the other hand, preheat time and temperature did not show significant influence.

The wire sweep analysis was carried out for 24 wire bonds. The results demonstrated, that wire sweep was influenced by the process parameters. Long wire bonds showed more deformation compared to short wire bonds. In general, the wire bonds attached close to the gate exhibited more deformation compared to the wire bonds attached far from the gate. The direction of the wire bonds relative to the gate did not show a remarkable influence on the wire sweep. Transfer speed showed a considerable impact on the wire sweep. Increasing the transfer speed caused more wire deformation. Small effect was observed for the temperature, and by increasing the temperature, the wire sweep slightly decreased. Preheat time and holding pressure did not show notable impact on the wire deformation.

After the regression analysis, the optimum process parameters for a minimum number of voids and a minimum wire sweep were defined. The parameter combinations are given in Table III.

The models which enable the estimation of the number of voids and wire sweep were generated with the help of a regression analysis. Validation experiments were carried out to verify the models. The results obtained from the validation experiments were compared with the results estimated with the model. Both results were found very close to each other. Thus, the mathematical models described the correlations between process parameters and quality characteristics very good and delivered very promising results for the estimation of the number of voids and wire sweep.

REFERENCES

- [1] K.W. Tong, C.K. Kwong, and K.M. Yu, "Process optimization of transfer moulding for electronic packages using artificial neural networks and multiobjective optimization techniques," *International Journal of Advanced Manufacturing Technology*, vol. 24, 2004, pp. 675-685.
- [2] L.T. Nguyen, "Reactive flow simulation in transfer molding of IC Packages," *Proceedings 43rd IEEE Electronic Components and Technology Conference*, 1993, pp. 375-390.
- [3] J. H. Wu, A. A. O. Tay, K. S. Yeo, and T. B. Lim, "A three-dimensional modeling of wire sweep incorporating resin cure," *IEEE Transactions on components, packaging, and manufacturing technology*, Part B, vol. 21, no.1, 1998, pp. 65-72.
- [4] T. Wember, *Technische Statistik und statistische Versuchsplanung, Einführung in statistische Methoden mit Anwendungsschwerpunkt in der Analyse technischer Daten für Techniker, Ingenieure und Naturwissenschaftler*; P & P Informationstechnologie GmbH, 2008.

- [5] W. Kleppmann, *Taschenbuch Versuchsplanung: Produkte und Prozesse optimieren*; 5. Auflage; Hanser: München; ISBN 978-3-446-41595-9 2008.