

Innovative Power Engineering in a Selected Rural Commune

Pawel Sowa, Joachim Bargiel

Abstract—This paper presents modern solutions of distributed generation in rural communities aiming at the improvement of energy and environmental security, as well as power supply reliability to important customers (e.g. health care, sensitive consumer required continuity). Distributed sources are mainly gas and biogas cogeneration units, as well as wind and photovoltaic sources. Some examples of their applications in a selected Silesian community are given.

Keywords—Energy security, power supply reliability, power engineering, mini energy centers.

I. INTRODUCTION

THE issue of energy security is of growing importance for all countries. The problem of energy security is global (entire state) and local (local government units), as well as energy security in the short- and long-term. Energy security is important for the supply of electricity, heat and transport fuels. Local Government Units observing the phenomenon of economic, technical, social, and carrying out their basic tasks imposed by the state administration, take measures to improve the energy security of its territory. The improvement will be made by an increase of the supply reliability to important municipal buildings (offices of municipalities, crisis management centers, health centers and hospitals, school gyms, kitchens and canteens, sports facilities, buildings, fire brigades, indoor swimming pools, etc.) and by investments in the area of distributed generation (DG) [1]. The improvement of power supply reliability will be realized through the construction of (mostly) gas cogeneration units in these buildings or in their vicinity, which will enable both the main and emergency power supply. In Poland, there is still more support for concepts and realizations of such projects [2]. These are called mini power centers of municipalities. They include small generating units and equipment which are very important for the organization of work in the municipality (for instance because of military security and health). Such equipment must be supplied and maintained even during blackout periods. In such a case, they work autonomously creating so-called mini power islands. Rural communities consume approximately 12% of the country's overall electricity supply.

Pawel Sowa is with the Silesian University of Technology, Poland (e-mail: pawel.sowa@polsl.pl).

II. LOCAL GOVERNMENT UNITS AS PROSUMER ENTITIES

The local and global power industry faces new challenges due to the current and future situation in the NPS and the forecasts concerning the development of various types of power generation sources. These are connection, operational, dispatching and economic challenges. As regards to the problem of connecting to the network, new sources appear mainly in 110 kV networks (wind farms), as well as medium and low voltage networks (biogas power plants, small water power plants, single wind sources). As a result, there arise problems associated with the change in the flow of currents and the problems connected with the change in short-circuit and voltage conditions [3].

From the point of view of the local government unit, the role of DG will be as follows:

- To increase in the local energy security;
- To improve the power supply reliability to important municipal consumers (hospitals, schools, health, recreation and sports centers), especially during failures enabling the island operation to supply these consumers;
- To cooperate with distribution network operators in mitigating the effects of failure or power deficit in the NPS which may be due to the decreasing level of the spinning reserve;
- To reduce transmission losses;
- To achieve the ecological effect by limiting CO₂ emissions;
- To increase the development potential of municipalities in the field of DG development using local energy resources;
- And additionally, to implement some legal acts important for local government units.

III. MAIN TASKS OF THE COMMUNE TO ENSURE LOCAL ENERGY SECURITY

The commune's own tasks are:

- Ensuring increasingly higher standards of electricity, heat and gas supply reliability to important municipal (communal) consumers and citizens;
- Making plans and energy balances for the commune by:
 - assessment of local demand for heat and electricity,
 - assessment of local energy resources and their use (in particular renewable resources),
 - selection of important heat and electricity consumers,
- Energy modernization,
- Optimal location of modern heat and electricity generation sources,
- Implementation of the climate package by the municipality,

- Optimal location of heat and electricity generation sources being also emergency sources.

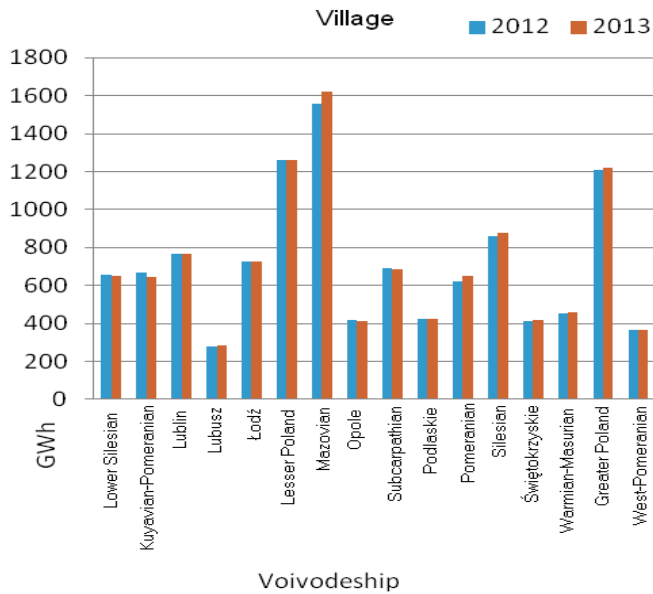

Fig. 1 Electricity demand of rural municipalities

Fig. 1 shows the energy consumption in particular voivodeships (towns and villages) in Poland in the years 2012 and 2013 [4], [5]. In 2012 and 2013, energy consumption in the cities decreased slightly, which might result from a greater awareness by people in energy saving and the more efficient use of the energy produced. However, in rural areas, energy consumption increased. The difference is not big, but visible. It may suggest the development of agriculture in particular provincial areas [6]. Referring only to the Silesian Voivodeship, it can be noted that the energy consumption has increased over years. This phenomenon can be observed both in urban and rural areas. Rural communities consume approximately 12% of electric power.

The consumption of the primary energy in the selected Silesian commune (Gierałtowie Commune – 11,500 residents, four villages, 3,000 residential buildings, 30 municipal buildings) is presented below. The estimated annual energy consumption and the profile of the community were determined based on the monitoring of energy consumption [7], [8].

Energy consumption in the Gierałtowie Commune:

Electric power:

- 20 000 MWh/year for individual consumers;
- 3 000 MWh/year for municipal consumers

Natural gas;

- 1 mln m³/year

Heat;

- 430 000 GJ/year for individual consumers;
- 25 000 GJ/year for municipal consumers.

IV. TARGET PROSUMER ENERGY MODEL IN THE SELECTED SILESIAN COMMUNE



Fig. 2 Energy situation in the selected commune

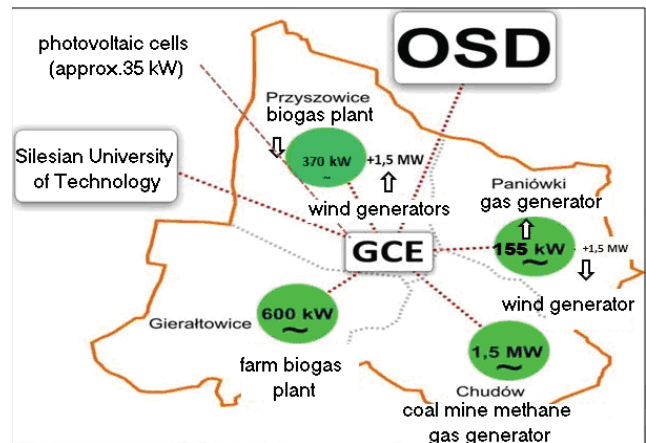

Fig. 3 Mini energy centres in the Gierałtowie Commune

TABLE I
DEMAND OF IMPORTANT CONSUMERS OF THE COMMUNE

Object	kWh
Gierałtowie Commune – street lights	1014064,00
Gierałtowie Commune – other objects	343924,00
Municipal Public Library	4351,00
Municipal Cultural Centre in Gierałtowie	22 523,00
Swimming Pool Wodnik Ltd. company.	629 514,00
Primary School in Chudów	188 603,00
School and Pre-school Complex in Gierałtowie	86 207,00
School and Pre-school Complex in Paniówki	155 935,00
School and Pre-school Complex in Przystawice	133 410,00
Public Utility Enterprise Ltd. company	407 764,00
Total	2 986 295,00

It results from the presented profile of the municipality demand that four mini energy centers with a total installed capacity of approximately 55 MW are needed (Fig. 3). They include three biogas plants with a capacity of 1.1 MW (600+370+155), two 1.5 MW wind generators and one 1.5 MW cogeneration unit using coal mine methane. These sources are connected to a 20 kV network, but in emergency situations they can operate as autonomous areas [9], [10].

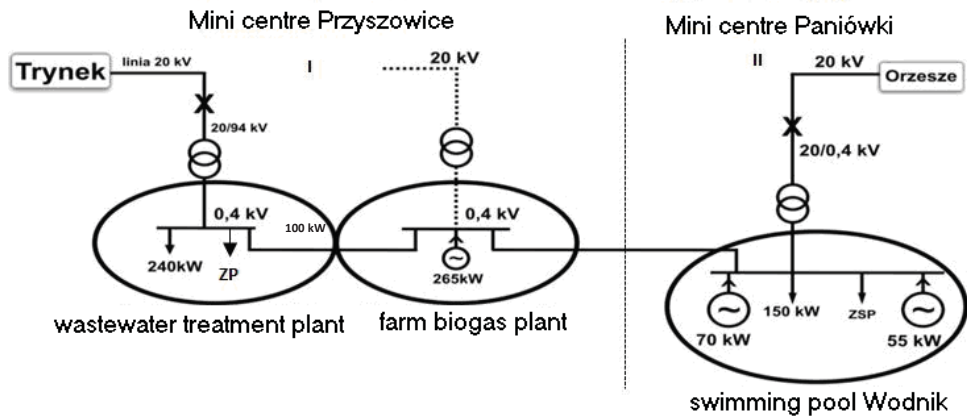

Fig. 4 The concept of Przyszowice – Paniówki Energy Island joining 2 mini energy centers



Fig. 5 Cogeneration unit 55kW

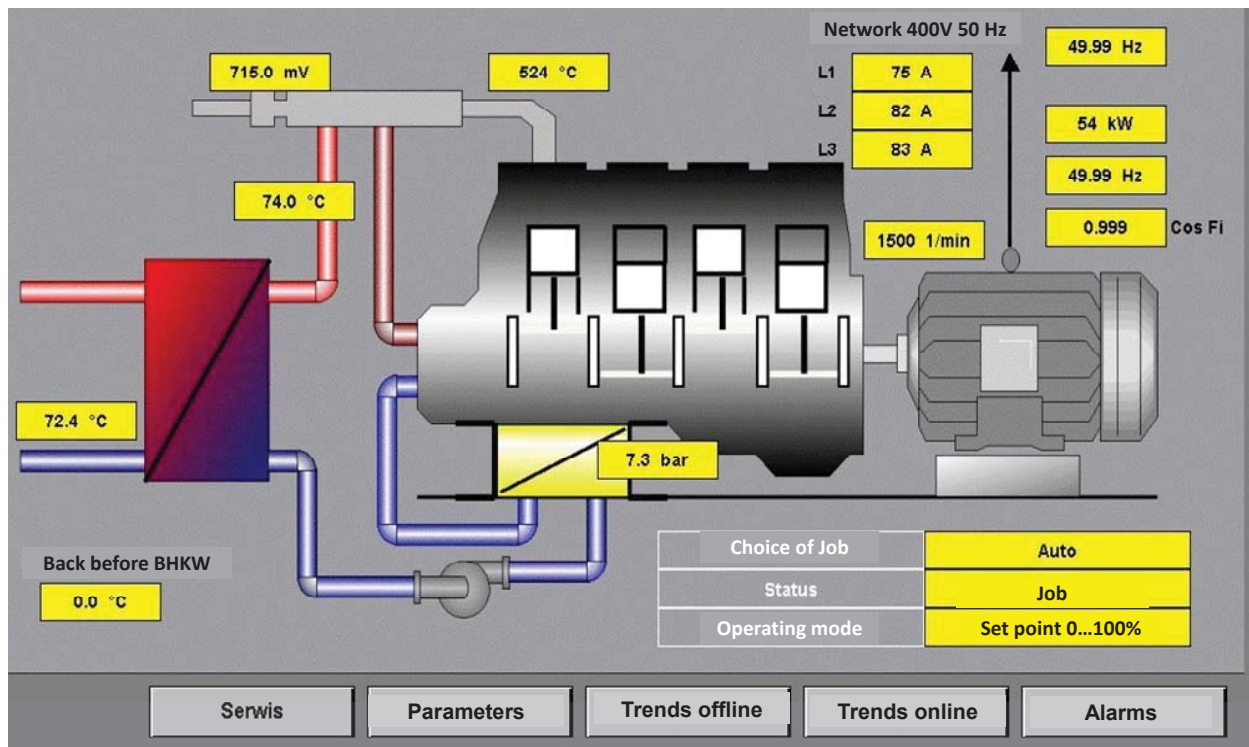

Fig. 6 Exemplary cogenerator operational parameters



Fig. 7 Wastewater treatment plant with a biogas plant



Fig. 8 Przyszowice palace complex with the health center, the Office of Civil Status and a kindergarten

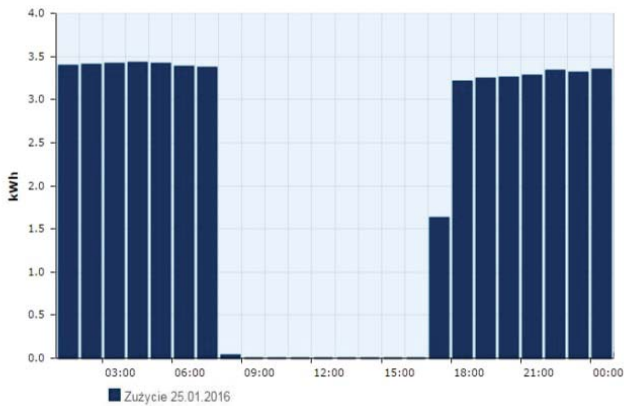

Fig. 9 Energy consumed daily by the street lighting – example

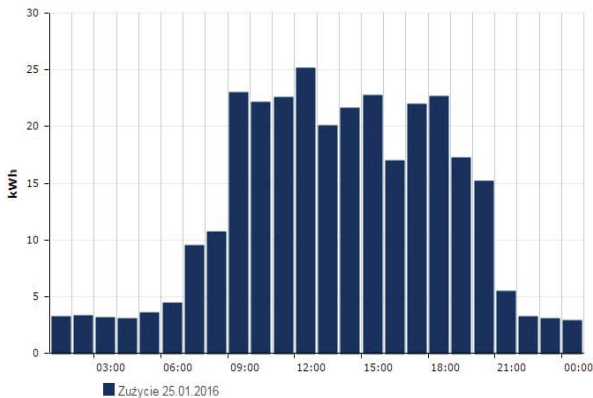

Fig. 10 Energy consumed daily by one of municipal schools – example

Annual electricity consumption in particular tariff groups of municipality units

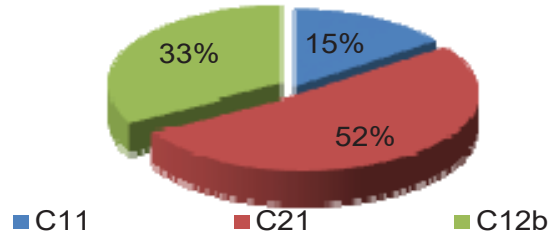
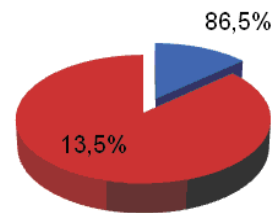

Fig. 11 Annual electricity consumption in particular tariff groups of municipality units



Annual electricity consumption

■ Units of Gierałtowiec Commune ■ Other consumers

Fig. 12 Annual electricity consumption in the selected commune

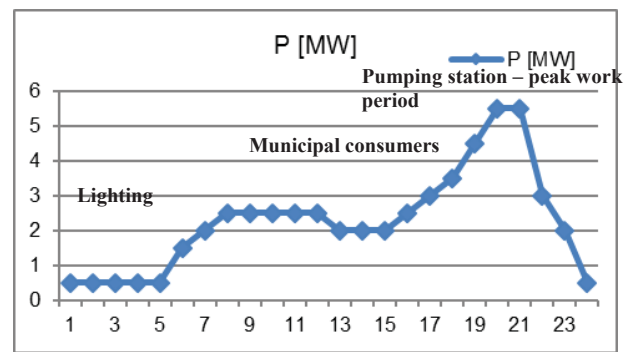

Fig. 13 Estimated graph of the whole community day (summer day)

V. SUMMARY

The presented exemplary innovative solutions in the selected commune enable one to:

- Balance the demands with the capabilities of distributed generation;
- Increase the energy security in the municipality;
- Maintain autonomous operation of important loads or objects in emergency conditions;
- Improve the power supply reliability to municipal consumers;

- Generate some surplus energy (e.g. 1-1,5 MW for the analysed commune, especially in situations of power deficit in the NPS and a local area network);
- Control the supply and demand for active and reactive power in the areas of mini energy centres.

REFERENCES

- [1] J. Bargiel, J. Paska, P. Sowa, "Ways of Mitigation of Potential Power and Energy Deficits in the Polish Electric Power System", *RYNEK ENERGII*, October 2011, Issue: 5, pp. 14-19.
- [2] J. Bargiel, P. Sowa, K. Zajac, "Methods of Improvement of Reliability in Medium Voltage Networks - Energy Policy Communities", *RYNEK ENERGII*, April 2011, Issue: 2, pp. 95-101.
- [3] J. Bargiel, W. Goc, P. Sowa, J.Paska, "Problems of reliability and power quality assessment in Polish electric power system", *IEEE Power Engng Soc Ninth International Conference on Harmonics and Quality of Power Proceedings, Vols I - III*, 2000, pp. 97-104.
- [4] Statystyka elektroenergetyki polskiej (Statistics of Polish power system), ARE SA Warszawa 2014.
- [5] Informacja statystyczna o energii elektrycznej (Statistical information on electricity), ARE SA, Warszawa 2015.
- [6] J. Bargiel, W. Goc, B. Teichman, P. Sowa, "Components reliability parameters by mid-term deficit of electric energy" IEEE AFRICON 2009, 23-25 September 2009, Nairobi, Kenya, ISBN: 978-1-4244-3919-5/09/2009, IEEE 1-5.
- [7] J. Bargiel, B. Mol, K. Łuszcz, P. Sowa, „Importance of Distributed Generation in the National Power System Based on the Example of Gieraltowice Commune”, *Acta Energetica*, pp. 31-42.
- [8] J. Bargiel, P. Sowa, K. Zajac, B. Mól, T. Sierociński, "Security of rural communes' and security of the National Power System", *Energetyka*, May 2012, special issue No XXIII, pp. 23-28.
- [9] J. Bargiel, W. Goc, P. Sowa, B. Teichman, T. Sierociński, "The risk of failure in local distribution systems", *Safety of the Polish power system, Edition 2012*, ISBN 978-83-7712-072-9, pp. 79-85.
- [10] P. Sowa, J. Bargiel, B. Mol, K. Łuszcz, "Technical and Economic Environment in the Polish Power System as the Basis for Distributed Generation and Renewable Energy Sources Development", May, 2015, Montreal, Canada. World Academy of Science, Engineering and Technology, pp. 796-800.

Professor Pawel Sowa (M'2000) holds a Doctorate Degree, as well as Doctorate of Science in Technical Science from Silesian University of Technology, Poland. He is currently Dean of the Faculty of Electrical Engineering and Director of the Institute of Power Systems and Control, Silesian University of Technology. Throughout his academic career he has published more than 200 scientific publications in many international referred journals and conferences proceedings. Prof. Sowa has served as a project leader/principal investigator to 13 projects with another 48 as active co-researchers. He has been actively involves in many consultancies and invited to talk in various seminars, dialogues and conferences (26 invited lectures at universities and foreign enterprises, 12 internships at foreign universities from 1 to 8 months, 7 signed letters of intent, 8 bilateral agreements and grants management, review, collaboration with international industry. Specialist in power engineering, power system modelling and transient electromagnetic phenomena. He has also won several awards in international and national research competitions.

Dr Joachim Bargiel holds a Doctorate Degree in Technical Science from Silesian University of Technology, Poland. An assistant professor at the Institute of Electrical Power and Systems Control of the Silesian University of Technology, Voigt of the Gieraltowice Commune. Author of numerous papers and articles on the reliability of power systems, a promoter of e-municipality and distributed energy generation.