

# Two Degree of Freedom Spherical Mechanism Design for Exact Sun Tracking

Osman Acar

**Abstract**—Sun tracking systems are the systems following the sun ray by a right angle or by predetermined certain angle. In this study, we used theoretical trajectory of sun for latitude of central Anatolia in Turkey. A two degree of freedom spherical mechanism was designed to have a large workspace able to follow the sun's theoretical motion by the right angle during the whole year. An inverse kinematic analysis was generated to find the positions of mechanism links for the predicted trajectory. Force and torque analysis were shown for the first day of the year.

**Keywords**—Sun tracking, theoretical sun trajectory, spherical mechanism, inverse kinematic analysis.

## I. INTRODUCTION

SOLAR tracking systems are a recent study area to enhance absorbed solar energy. It is well-known that tracking sun rays at right angles with solar panels can relatively increase produced electrical energy according to physical rules. Mobile solar panels are able to track the sun rays at right angle or close to right angle by the help of azimuth and elevation angles. But fixed solar panels cannot track sun rays due to their unchangeable directions.

There are several studies with various methods about mobile solar systems. Optimized design of a large-workspace 2-DOF parallel robot for solar tracking system was designed to follow the sun's apparent motion during the year at latitudes among  $0^\circ$  and  $50^\circ$ . Universal and spherical joints have been designed to allow the mechanism to move from  $-90^\circ$  to  $90^\circ$  for the azimuth angle and from  $0^\circ$  to  $90^\circ$  for the elevation angle. Energy assessment of the system has been performed comparing to two fixed systems with inclination of  $0^\circ$  and  $30^\circ$ , respectively. An overall increase of 17.2% in energy production was calculated when comparing the proposed tracking system and the fixed system with an inclination of  $30^\circ$  [1].

The sun tracking system of a solar dish based on computer image processing of a bar shadow is done by using a camera to obtain the optimized picture of a bar shadow on a screen by solar dish displacements. This system is independent respect to geographical location of the solar dish and periodical alignments such as daily or monthly regulations. Furthermore, the operation of the system is independent respect to the initial configuration and the start time situation. It is necessary to use the special camera for picture processing. One of the most important specification of present controlling system is also the self-adjustment and do not regulate dish in the cloudy

Osman Acar is with the Department of Mechanical Engineering, Selcuk University, Konya, Turkey (e-mail: osmanacar@selcuk.edu.tr).

conditions to save energy. Set up this system in any position is very simple. By variation of the length of telescopic bar the sensitivity of the system is changed [2].

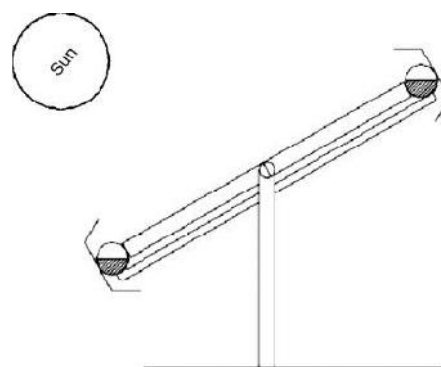

Fig. 1 A passive solar tracker using two identical cylindrical tubes filled with a fluid under partial pressure [3]

Clifford MJ and Eastwood D. presented a novel passive solar tracker modeled with computer [3]. They mentioned that although the expanding metals generated deflections were small, the corresponding forces were large. Their passive solar tracker design incorporates two bimetallic strips made of aluminum and steel, positioned on a wooden frame, symmetrically on either side of a central horizontal axis. The bimetallic strips are shaded so that the strip further from the sun absorbs solar radiation while the other strip remains shaded in a similar fashion to the design illustrated in Fig. 1. To prevent oscillation or too sluggish respond, a damping system is linked to the sun tracker. They compared the computer model and experimental results of deflections of the bimetallic strip due to the effects of thermal radiation (in mm) and time taken for the solar tracker to reorient from W-E. The computer model and experimental data showed results very similar to each other. The designed solar tracker had the potential to increase solar panel efficiency by up to 23%. Finally, they recommended night return mechanism, manually tilted axis and dual axis system for future development.

## II. SPHERICAL MECHANISM FOR SUN TRACKING

### A. Theoretical Trajectory of Sun Motion

In sun tracking, several methods have been used from physical features of materials in the existence of temperature to image processing in the existence of sun vision to determine the trajectory. In our system, sun tracking requires a mathematical formulation for path of sun motion to predict a trajectory for the spherical mechanism.

Theoretical sun position is determined based on two couple angles in the equatorial and horizontal coordinate systems by the help of spherical geometry.

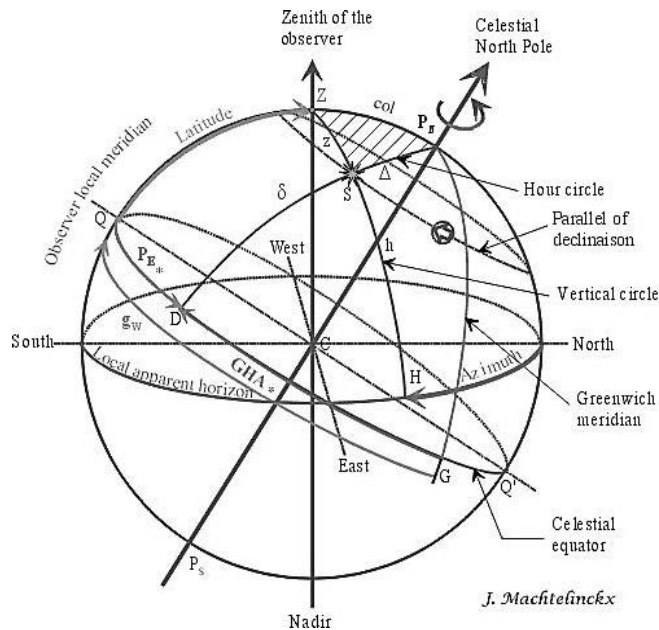

Fig. 2 Coordinates of Sun in Equatorial and Horizontal Coordinate Systems [5]

In Fig. 2, coordinates of sun is determined by the help of declination angle ( $\delta$ ) and Greenwich Hour Angle (GHA) in equatorial coordinate system. Additionally, they are shown by means of azimuth ( $\gamma$ ) and altitude ( $\alpha$ ) angles in the horizontal coordinate system. The hatched spherical triangle is composed of the arcs of sun position with respect to two coordinate systems. The edges of the triangle are the complementary angles of the needed angles of the coordinates of sun. By using cosine rule of spherical trigonometry, azimuth and altitude angles are found in the following equations.

The cosine rule and the used form of the rule in our system;

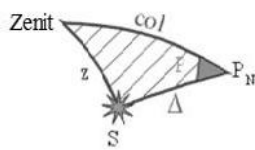

Fig. 3 The spherical triangle for position of the sun [5]

$$\cos z = \cos(\text{col}) \cos \Delta + \sin(\text{col}) \sin \Delta \cos P \quad (1)$$

$$\cos \Delta = \cos(\text{col}) \cos z + \sin(\text{col}) \sin z \cos(\text{azimuth}) \quad (2)$$

Because of complementary relation of angles, cosine functions replace with sinus functions;

$$\sin h = \sin(\text{lat}) \sin \delta + \cos(\text{lat}) \cos \delta \cos(\text{long} - \text{GHA}) \quad (3)$$

$$\sin \delta = \sin(\text{lat}) \sin h + \cos(\text{lat}) \cos h \cos(\text{azimuth}) \quad (4)$$

Writing  $\alpha$  in the place of  $h$ ,  $\omega$  in the place of  $P$  (long-GHA),  $\gamma$  in the place of azimuth and  $\phi$  in the place of latitude and rearranging;

$$\sin \alpha = \sin \phi \sin \delta + \cos \phi \cos \delta \cos \omega \quad (5)$$

$$\sin \delta = \sin \phi \sin \alpha + \cos \phi \cos \alpha \cos \gamma \quad (6)$$

Simplifying this for the altitude angle;

$$\alpha = \sin^{-1}(\cos \phi \cos \delta \cos \omega + \sin \phi \sin \delta) \quad (7)$$

$$\gamma = \cos^{-1} \left( \frac{\sin \delta - \sin \phi \sin \alpha}{\cos \phi \cos \alpha} \right) \quad (8)$$

These angles are calculated for the circle of 24 hours and 365 days in  $37^\circ 52' 0''$  north latitude. By using altitude and azimuth angles, components of sun position vector ( $\vec{B}$ ) is written in X, Y, Z axes in horizontal coordinate system and shown on a unit sphere.

$$\begin{aligned} X_B &= \cos \alpha \cos \gamma \\ Y_B &= \cos \alpha \sin \gamma \\ Z_B &= \sin \alpha \end{aligned} \quad (9)$$

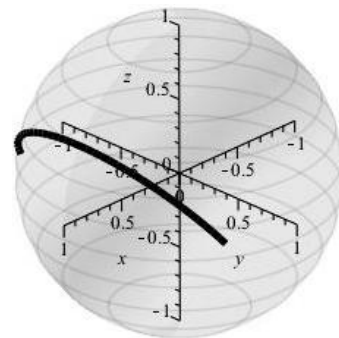

Fig. 4 The Trajectory of Sun Motion in 6th Day of Year in  $37^\circ 52' 0''$  north latitude

### B. Geometry of Spherical Mechanism

In spherical mechanisms, the links are represented by a segment of great circles. The great circle is the intersection of the spherical surface with a plane passing through two points on spherical surface and the center of the sphere. In spherical kinematics the distance between two points on the surface of the unit sphere is measured by the angle subtended by the arc of the great circle passing through these two points at the sphere center. A spherical angle between two great circles is the dihedral angle made by the planes of the two great circles [4].

The sun has various trajectories over days of year. A single degree of mechanism cannot follow such various trajectories. For sun tracking at right angle, two degrees of spherical five-bar mechanism has been used shown as in Fig. 5. In the mechanism, the plane of the great circle of fixed link is taken as OXZ plane for simplicity.  $A_0$  and  $D_0$  are the fixed joints whose axes pass through unit sphere center. A, B, D are revolute joints whose axes pass through unit sphere center as

well. Lengths symbolized by  $AA_0$ ,  $AB$ ,  $BD$ ,  $DD_0$  are the angles subtended by the great circle arcs representing links from sphere center in Fig. 5.

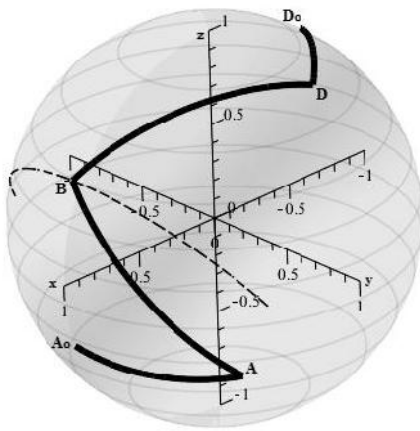

Fig. 5 Spherical mechanism for sun tracking

Points of  $A_0$ ,  $B$ ,  $A$  form a spherical triangle on the spherical surface as shown in Fig. 6. The arcs of  $A_0B$  and  $BA$  define the location of point  $A$ . After finding the length of  $A_0B$  arc, we find spherical angle  $A_0$  by using cosine rule in spherical trigonometry. The length of  $A_0B$  edge of  $A_0OB$  planar triangle in the plane of the great circle of  $A_0B$  arc is found by using known coordinates of point  $B$  and  $A_0$  ((10), (11)). The same process is done for finding the coordinates of point  $D$ .

$$A_0B = 2\sin^{-1}[\sqrt{((X_B - X_{A_0})^2 + (Y_B - Y_{A_0})^2 + (Z_B - Z_{A_0})^2)^{1/2}}/2] \quad (10)$$

$$A_0 = a \quad \left[ \frac{c(A) - c(AA_0)c(A_0B)}{s(A)s(A_0B)} \right] \quad (11)$$

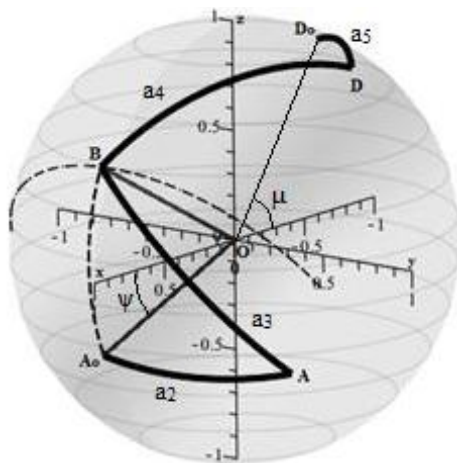

Fig. 6 Spherical triangle and planar triangle in the mechanism  $A_0A$ ,  $AB$ ,  $BD$ ,  $DD_0$  are named as  $a_2$ ,  $a_3$ ,  $a_4$ ,  $a_5$  respectively

### C. Inverse Kinematic Analysis of Spherical Mechanism

A great circle is the intersection of spherical surface and a plane passing through two points on spherical surface and the center of the sphere. All great circles on the sphere are

obtained by rotating the plane by  $\beta$  and  $\alpha$  angles about  $Z$  and  $X$  axes respectively as shown in Fig. 6.

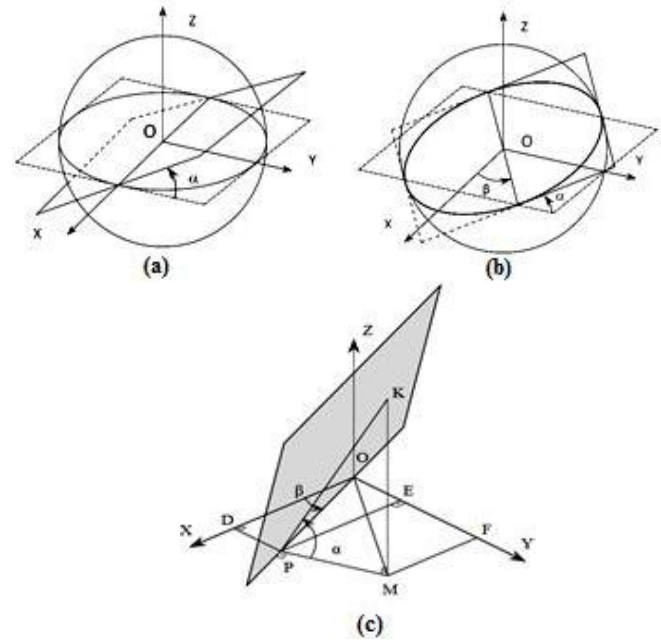

Fig. 7 (a), (b) Rotated planes in sphere. (c) Projections of the intersection point

In the Fig. 7 (c), the point  $K$  and  $P$  is an intersection point of the plane rotated in sphere in Figs. 7 (a), (b). The point  $M$  is the projection of the point  $K$  and vertical to point  $P$ .  $z$  coordinate of the point  $K$  is calculated as;

$$\tan \alpha = \frac{KM}{MP} = \frac{z}{MP}$$

$$z = MP \tan \alpha \quad (12)$$

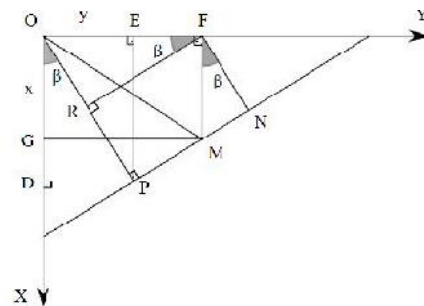

Fig. 8 The view of the projection of the rotated plane on  $OXY$

The coordinates of point  $K$  in  $OXY$  plane;

$$OG = x \text{ and } OF = y.$$

From Fig. 8;  $MP = PN - MN$ ;  $FR = PN = y \cos \beta$   $FM = OG$ ;  $MN = FM \sin \beta = x \sin \beta$  can be seen.

$$MP = y \cos \beta - x \sin \beta \quad (13)$$

Substituting (13) in (12) and simplifying;

$$z + \tan\alpha(x \sin\beta - y \cos\beta) = 0 \quad (14)$$

Equation (14) is general equation of the plane passing through origin and the plane rotated about X by  $\alpha$  and about Z by  $\beta$ . Equation (14) is valid also for the points on the great circle which is the intersection of sphere and the rotated plane.

In the spherical five-bar mechanism,  $\theta_5$  and  $\theta_2$ , which are the angles of  $a_5$  and  $a_2$  with respect to the vertical axis respectively, are calculated as following.

When the plane of great circle  $A_0B$  is rotated about  $OA_0$  axis by  $\varepsilon$  angle, the point B goes to point B' and the plane of great circle arc  $A_0B'$  coincides with the plane wherein great circle arc  $A_0A$  is, so eventually  $A_0$ , A and B' points are in the same plane.

The coordinates of B';

$$\mathbf{X}_{B'} = \mathbf{T} \mathbf{X}_B \quad (15)$$

Here,  $\mathbf{T}$  is the rotation matrices about  $OA_0$ ;

$$\mathbf{T} = \begin{bmatrix} x_{A_0}^2 K + \cos\varepsilon & x_{A_0} y_{A_0} K - z_{A_0} \sin\varepsilon & x_{A_0} z_{A_0} K + y_{A_0} \sin\varepsilon \\ x_{A_0} y_{A_0} K + z_{A_0} \sin\varepsilon & y_{A_0}^2 K + \cos\varepsilon & y_{A_0} z_{A_0} K - x_{A_0} \sin\varepsilon \\ x_{A_0} z_{A_0} K - y_{A_0} \sin\varepsilon & y_{A_0} z_{A_0} K + x_{A_0} \sin\varepsilon & z_{A_0}^2 K + \cos\varepsilon \end{bmatrix}$$

$$K = 1 - \cos\varepsilon$$

$$\mathbf{X}_B = [x_B \ y_B \ z_B]^T \text{ and } \mathbf{X}_{B'} = [x_{B'} \ y_{B'} \ z_{B'}]^T$$

The equation of the plane of  $A_0$  and B' points is like (14). According to the known values of coordinates of these two points, values of  $\alpha$  and  $\beta$  are found simply by the help of following equations:

$$z_{A_0} + \tan\alpha(x_{A_0} \sin\beta - y_{A_0} \cos\beta) = 0 \quad (16)$$

$$z_{B'} + \tan\alpha(x_{B'} \sin\beta - y_{B'} \cos\beta) = 0 \quad (17)$$

Two equations are divided with each other to find the value of  $\beta$  by the help of function atan2;

$$\beta = \arctan 2 \left( \frac{z_{A_0} y_{B'} - z_{B'} y_{A_0}}{z_{A_0} x_{B'} - z_{B'} x_{A_0}} \right) \quad (18)$$

The angle  $\alpha$  is calculated by the help of one of the two equations (16), (17). According to the known values of  $\alpha$  and  $\beta$  angles, the equation of plane of the point A can be written in the form of coordinates of point A:

$$z_A + \tan\alpha(x_A \sin\beta - y_A \cos\beta) = 0 \quad (19)$$

The spherical distance between point  $A_0$  and A or the angle  $A_0OA$  is obtained from scalar multiplication of  $\overrightarrow{OA_0}$  and  $\overrightarrow{OA}$  vectors, similarly the angle BOA is obtained from scalar multiplication of  $\overrightarrow{OB}$  and  $\overrightarrow{OA}$  vectors.

$$\cos AOB = \overrightarrow{OB} \cdot \overrightarrow{OA} = x_B x_A + y_B y_A + z_B z_A \quad (20)$$

$$\cos A_0OA = \overrightarrow{OA_0} \cdot \overrightarrow{OA} = x_{A_0} x_A + y_{A_0} y_A + z_{A_0} z_A \quad (21)$$

So that three linear equations for coordinates of point A in any position of  $a_2$  have been obtained by the help of (19)-(21). By solving of these equations, coordinates of A( $x_A$ ,  $y_A$ ,  $z_A$ ) is found simply. These three linear equations are also written for point D with the same method. For the whole motion of mechanism along days of whole year, coordinates are calculated in a mathematical software program.

#### D. Static Force and Torque Analysis of the System

In the sun tracking system, we assumed the force exerted by wind to the solar panel is in the direction of x axis. The force is changeable due to the variable direction angles of normal vector with the horizontal coordinate system.

$$F_{Ae} = q_z A_x C_d \quad (22)$$

In (22),  $q_z = 0.613V^2 [N/m^2]$  is the generic formula of the wind pressure. V is the velocity of the wind.  $A_x = A \cos\theta_x$  is the projected area of the panel.  $C_d = 2.0$  is the drag coefficient for flat plates [6].

We have three unknown forces in our system.  $F_3$ ,  $F_4$ , R are the unknown forces.  $F_3$  is the force exerted by  $a_3$ .  $F_4$  is the force exerted by  $a_4$ . R is the force exerted by the central rod of the panel. For the solution of these three unknown forces, first we determined the following vectors.

$$\mathbf{A}_1 = ((X_B - X_A)^2 + (Y_B - Y_A)^2 + (Z_B - Z_A)^2)^{\frac{1}{2}}$$

$$\mathbf{A}_2 = ((X_B - X_D)^2 + (Y_B - Y_D)^2 + (Z_B - Z_D)^2)^{\frac{1}{2}}$$

$$\mathbf{A}_3 = ((X_B - 0)^2 + (Y_B - 0)^2 + (Z_B - 0)^2)^{\frac{1}{2}}$$

$$\overrightarrow{u}_1 = [(X_B - X_A)/A_1, (Y_B - Y_A)/A_1, (Z_B - Z_A)/A_1]$$

$$\overrightarrow{u}_2 = [(X_B - X_D)/A_2, (Y_B - Y_D)/A_2, (Z_B - Z_D)/A_2]$$

$$\overrightarrow{u}_3 = [(X_B - 0)/A_3, (Y_B - 0)/A_3, (Z_B - 0)/A_3]$$

$$\overrightarrow{F}_3 = F_3 \overrightarrow{u}_1, \overrightarrow{F}_4 = F_4 \overrightarrow{u}_2, \overrightarrow{R} = R \overrightarrow{u}_3$$

From the static equilibrium;

$$\sum F_x = 0, F_3 \overrightarrow{u}_{1x} + F_4 \overrightarrow{u}_{2x} + R \overrightarrow{u}_{3x} + F_{Ae} = 0 \quad (23)$$

$$\sum F_y = 0, F_3 \overrightarrow{u}_{1y} + F_4 \overrightarrow{u}_{2y} + R \overrightarrow{u}_{3y} = 0 \quad (24)$$

$$\sum F_z = 0, F_3 \overrightarrow{u}_{1z} + F_4 \overrightarrow{u}_{2z} + R \overrightarrow{u}_{3z} = 0 \quad (25)$$

These three linear equations were used to solve three unknown forces. These three unknown forces were calculated with respect to the equally divided time steps for the first day of the year as shown Fig. 9.

$F_3$ ,  $F_4$  were used to calculate moments on the links named  $a_2$ ,  $a_5$  respectively. For the calculation of moments, unit vectors were determined. Cross product of unit vectors and forces were calculated.

$$A_4 = \left( (X_A - X_{A_0})^2 + (Y_A - Y_{A_0})^2 + (Z_A - Z_{A_0})^2 \right)^{\frac{1}{2}}$$

$$\bar{u}_4 = \left[ (X_A - X_{A_0})/A_4, (Y_A - Y_{A_0})/A_4, (Z_A - Z_{A_0})/A_4 \right]$$

$$A_5 = \left( (X_D - X_{D_0})^2 + (Y_D - Y_{D_0})^2 + (Z_D - Z_{D_0})^2 \right)^{\frac{1}{2}}$$

$$\bar{u}_5 = \left[ (X_D - X_{D_0})/A_5, (Y_D - Y_{D_0})/A_5, (Z_D - Z_{D_0})/A_5 \right]$$

$$\bar{M}_3 = \bar{u}_4 \times \bar{F}_3$$

$$\bar{M}_4 = \bar{u}_5 \times \bar{F}_4$$

For the torque of stepper motors, we calculated component of the moment for the direction of stepper motors by dot products between the position vectors of A<sub>0</sub>, D<sub>0</sub> and F<sub>3</sub>, F<sub>4</sub> forces. These stepper motors will

$$X_{A_0} = \cos\Psi, Y_{A_0} = 0, Z_{A_0} = -\sin\Psi$$

$$X_{D_0} = -\cos\mu, Y_{D_0} = 0, Z_{D_0} = \sin\mu$$

$$\bar{V}_1 = [X_{A_0}, Y_{A_0}, Z_{A_0}], \bar{V}_5 = [X_{D_0}, Y_{D_0}, Z_{D_0}]$$

$$M_1 = \bar{M}_3 \cdot \bar{V}_1, M_2 = \bar{M}_4 \cdot \bar{V}_5$$

The angles  $\Psi, \mu$  were set as  $20^\circ$  and  $53^\circ$  respectively for the fixed joints in the design as optimum working angles. Moments  $M_1, M_2$  were calculated days of whole year and are shown for the first day of the year in Fig. 10.

### III. CONCLUSION

Our study showed that the sun can be tracked by the spherical mechanism with the help of theoretical sun trajectory. The mechanism will be easier to design and compact in comparison to its counterparts. The mechanism requires very small magnitude of forces and torques.

The spherical mechanism is designed for 10 km/h velocity of wind. Some of the tests can be done as continuing studies. A prototype can be designed and tested for the azimuth and altitude angles. The strength of the system can be analyzed. The theoretical trajectory of the sun can be tested by observing the angle of the sun ray with respect to the solar panel during the day by using sensors for optimization. The efficiency of the system can be observed for days of whole year and compared with efficiency of its counterparts. An optimization can be done for lengths of links of the mechanism.

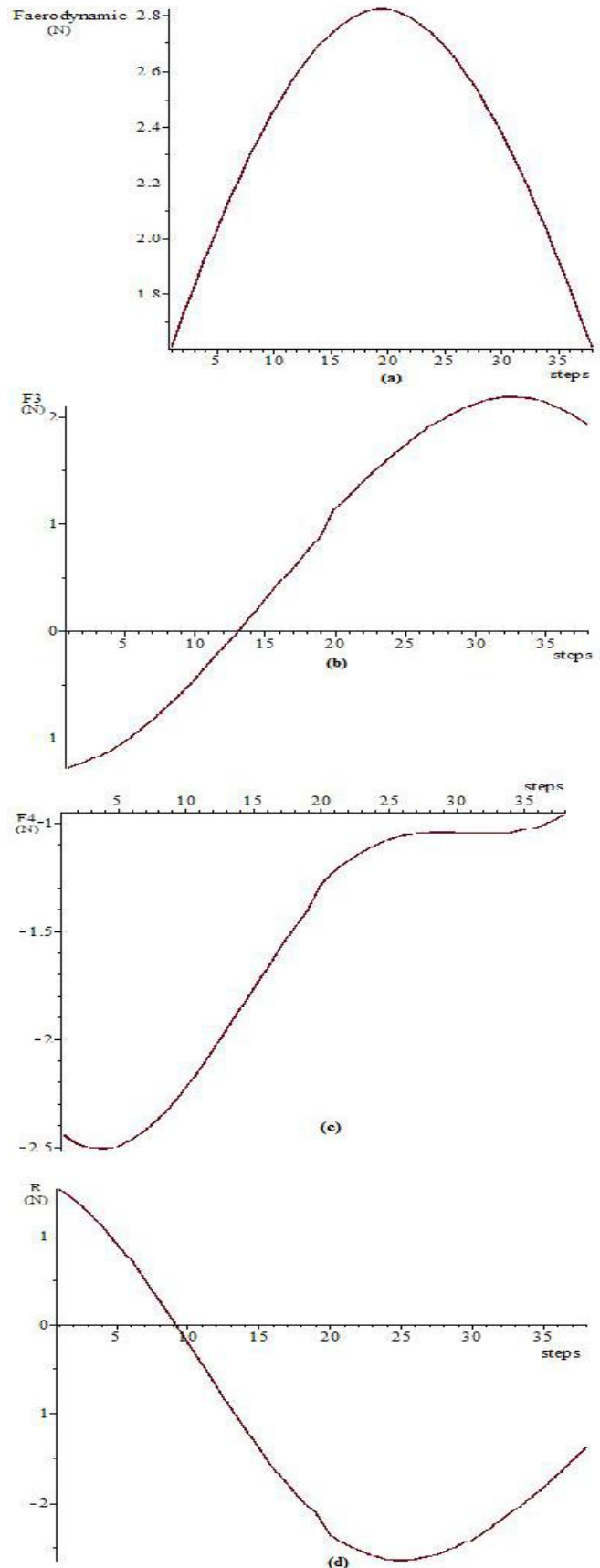

Fig. 9 Values of  $F_{Aerodynamic}, F_3, F_4, R$  for the first day of the year respectively

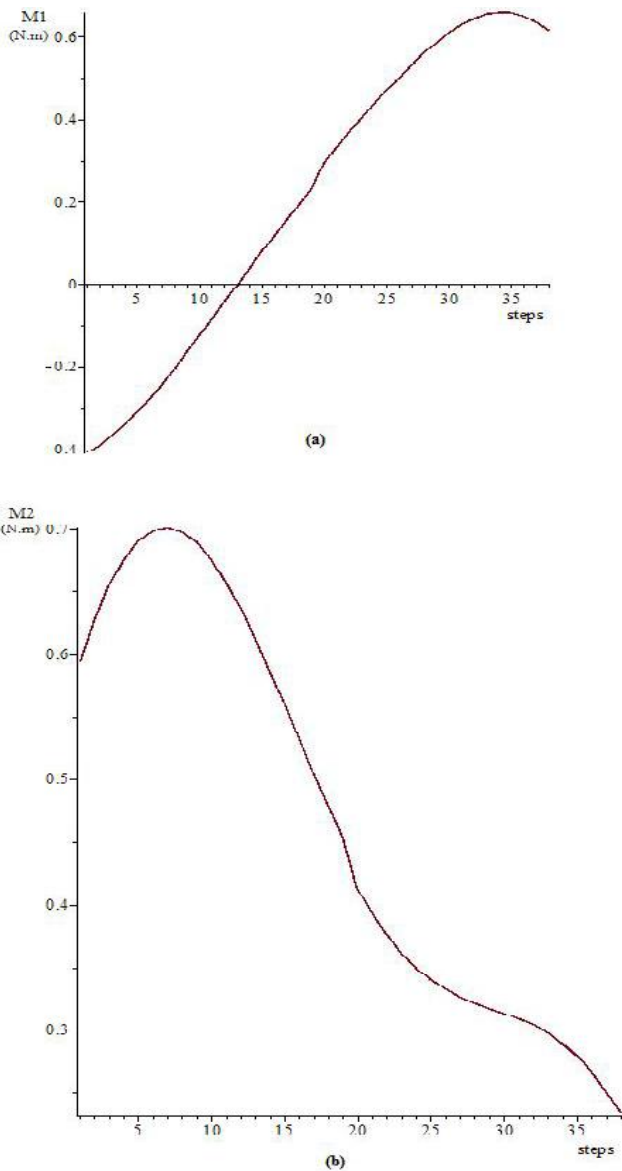

Fig. 10 Values of  $M_1$ ,  $M_2$  for the first day of the year respectively

#### REFERENCES

- [1] Alessandro Cammarata, "Optimized design of a large-workspace 2-DOF parallel robot for solar tracking systems," *Mechanism and Machine Theory* 83, Elsevier, 2015, pp. 175–186.
- [2] H. Arbab, B. Jazi, M. Rezagholizadeh, "A computer tracking system of solar dish with two-axis degree freedoms based on picture processing of bar shadow". *Renewable Energy* 34, Elsevier, 2009, pp. 1114–1118.
- [3] Clifford MJ, Eastwood D. "Design of a novel passive solar tracker.", *Solar Energy* 77, 2004, pp.269–80.
- [4] Chiang C.H., *Kinematics of Spherical Mechanisms*, Florida, Krieger Publ., 2000, ch.2.
- [5] Johan Machtelinckx, onboardintelligence.com/CelestialNav/CelNav4.aspx, 1999-2011.  
 ASCE 7 Minimum Design Loads for Buildings and Other Structures, pp. 31, ch.6.