

Design and Development of a Mechanical Force Gauge for the Square Watermelon Mold

M. Malek Yarand, H. Saebi Monfared

Abstract—This study aimed at designing and developing a mechanical force gauge for the square watermelon mold for the first time. It also tried to introduce the square watermelon characteristics and its production limitations. The mechanical force gauge performance and the product itself were also described. There are three main designable gauge models: a. hydraulic gauge, b. strain gauge, and c. mechanical gauge. The advantage of the hydraulic model is that it instantly displays the pressure and thus the force exerted by the melon. However, considering the inability to measure forces at all directions, complicated development, high cost, possible hydraulic fluid leak into the fruit chamber and the possible influence of increased ambient temperature on the fluid pressure, the development of this gauge was overruled. The second choice was to calculate pressure using the direct force a strain gauge. The main advantage of these strain gauges over spring types is their high precision in measurements; but with regard to the lack of conformity of strain gauge working range with water melon growth, calculations were faced with problems. Finally the mechanical pressure gauge has advantages, including the ability to measured forces and pressures on the mold surface during melon growth; the ability to display the peak forces; the ability to produce melon growth graph thanks to its continuous force measurements; the conformity of its manufacturing materials with the required physical conditions of melon growth; high air conditioning capability; the ability to permit sunlight reaches the melon rind (no yellowish skin and quality loss); fast and straightforward calibration; no damages to the product during assembling and disassembling; visual check capability of the product within the mold; applicable to all growth environments (field, greenhouses, etc.); simple process; low costs and so forth.

Keywords—Mechanical Force Gauge, Mold, Reshaped Fruit, Square Watermelon.

I. INTRODUCTION

MANUFACTURERS tend to bring innovation and offer new products to increase their market share for which they make considerable efforts every day. This is developing widely not only in industries and trade but also in agriculture and food industry as an example by reshaped fruit producing. However offering new products in agriculture requires us to deal with several factors such as high, undesirable risk tolerance and the like.

Watermelon (*Citrullus lanatus*) belongs to the *cucurbitacea*

Morteza Malek Yarand is Faculty Member, Institute of Applied Scientific Higher Education of Jihad-e-Agriculture (www.itvhe.ac.ir), Tehran & Head of Department of Agricultural Engineering and Machinery (IHEC) Karaj, Po. Box: 317777411 Iran, (Corresponding Author; phone: 00989121374841; fax: 00982636700880; e-mail: malekyarand.m@gmail.com) and he is also PhD Student of IUIM University.

Hadi Saebi Monfared is Faculty Member, Institute of Applied Scientific Higher Education of Jihad-e-Agriculture, (www.itvhe.ac.ir), Tehran, Iran, (phone: 00989126156590; fax: 00982166596700; e-mail: h_saebi@hotmail.com).

family. According to a FAOSTATE report, 94,965,472 tons of watermelon was produced in 2012. Iran with 3,800,000 ton was ranked third in the world [1]. Watermelon was first grown in Egypt 5,000 years ago. There are 1,200 varieties of watermelon grown in 96 countries [2].

Square watermelons were first developed in Japan and slowly began to prosper in other countries such as Iran [3]. In addition to offering a novel appearance, this particular shape of watermelon features several economic and environmental benefits including simple production method, easier loading, storing and shipping which bring about lower energy consumption and less urban and international traffic. These in turn offer incentives to buy and also to develop production in fields not proper for every crop. Nevertheless due to the high production cost and low consumer economic power, this product has not been well-received in many national markets. On the other hand, with the advent of state-of-the-art equipment and agro-technical strategies and approaches in agriculture, it is hoped that these conditions might change [4].

Generally for producing square watermelons, in addition to usual inputs (i.e. seed, fertilizer, etc.), a new input named mold is also involved. Indeed the production of these molds accounts for a large portion of the cost difference between square and regular watermelons [5]. In fact, there is not dependable authentic data on the standard amount of materials required to make these molds. Considering the force applied to the sides of these molds, its walls should be neither too thick to raise production costs nor too thin to make it sensitive to stresses imposed by watermelons [6].

II. THEORETICAL PRINCIPLES

In normal situations, a watermelon with an average one hundred percent sphericity is a massive product and hard to carry.

Sphericity can be quantified as follows:

$$\Psi = \frac{A_s}{A_p} \quad (1)$$

where:

A_s : the sphere projection's surface area

A_p : Maximum surface area in cross-section profile

In general and according to measurement of some spherical watermelon variety -such as crimson sweet- these two values are so close that they can be assumed equal and take their ratio as 1. This means that the watermelon has sphericity [7].

Also note that the higher sphericity values normally decrease the stacking volume in a given space, as a large volume will be accommodated by void (porosity).

Compare the following figures:



Fig. 1 (a) The amount of loading of the spherical watermelon

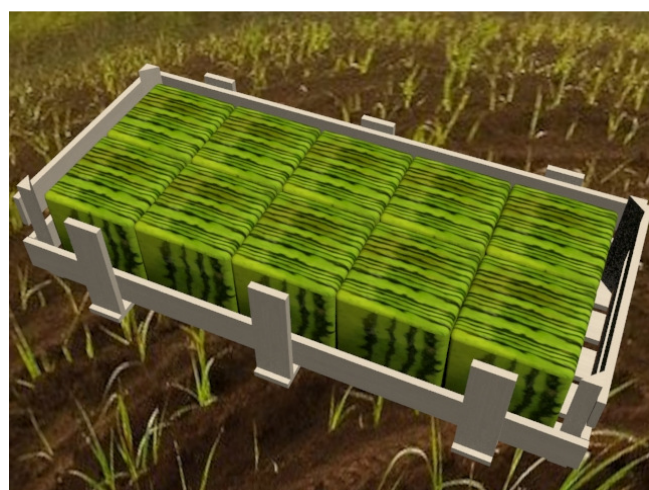

Fig. 1 (b) The amount of loading of the square watermelon

In Fig. 1 (a), a considerable volume is occupied with empty spaces due to the watermelon shape.

Fig. 1 (b) fully shows the amount of square watermelons that can be loaded in a given space, in which there is no empty space. That is, in a fixed space, more volume and therefore more products can be loaded.

Spherical watermelon loading percent:

Assuming a perfect sphericity and the average radius of 10 cm and a 5 kg weight for each melon, we have:

$$\frac{4\pi r^3}{3} = \frac{4 \times 3.14 \times 0.001}{3} = 0.004 \text{ (m}^3\text{)} \quad (2)$$

By considering the volume of a 6-axis truck being fully loaded:

$$v' = L \times W \times H = 10 \times 2.2 \times 1.8 = 39.6 \text{ (m}^3\text{)} \quad (3)$$

If half of the loading space is empty:

$$v'' = 39.6/2 = 19.8 \text{ (m}^3\text{)} \quad (4)$$

Thus:

$$v''/v = 19.8/0.004 = 4950 \quad (5)$$

Accordingly, 4950 watermelons can be loadable. With regard to the 5kg mean weight, 24.75 tons of watermelon can be loaded.

While with the omission of square watermelon loading volume with the volume of 0.004 m³ and the average weight of 6.5 kg:

$$v = l^3 = 0.004 \text{ (m}^3\text{)} \quad (6)$$

Therefore:

$$v'/v = 39.6/0.004 = 9900 \quad (7)$$

Accordingly, 9900 square watermelons can be loaded and, considering an average weight of 6.5 kg for each square watermelon, 64.35 tons of watermelon can be loaded.

On this basis, it can be asserted that square watermelons have one hundred percent higher loading capacity than spherical watermelons. This, in turn, can be translated into decreased transportation costs per each kilogram of the product and decreased urban and inter-urban traffic, and also reduced fuel consumption and carrier vehicle depreciation.

III. MATERIALS AND METHODS

Different materials (e.g. metal, MDF, glass and Plexiglas mold) can be used for reshaping watermelons. Due to high sunlight absorption and conductivity, metallic molds are not suitable. Transferred heat warms the watermelon surface severely and skin burns or sings appear. Additionally, due to lack of light passing through, the watermelon skin color becomes undesirable. MDF molds has always been suitable for their high strength, comfort, high cutting accuracy and low costs good, however, their lack of transparency, first, holds back light from reaching the watermelon skin that causes the discoloration of the skin and reduces its marketability; second, it prevents the examination of watermelon situation during the growth in the mold. In fact, farmers would not be able to check the appearance elements of their crops during the growth stage. Glass molds have solved the non-transparency problem. However, their high production costs, low cutting accuracy, high probability of failure under field conditions and under pressure of watermelon, low ventilation, low sunlight heat conductivity (34-68%) as watermelon is a hot season fruit, and causing high transpiration which results in fungi, withering or mildew are the major setbacks for its production.

The molds made by Plexiglas have enough transparency to pass the light, have enough strength (more than glass) against field conditions, and have better ventilation capability [8]. Other benefits include low weight, high elasticity and high cutting accuracy. Additionally, the watermelon deformation occurs easily in contact with this type of mold.

Therefore, we decided design and develop a mechanical force gauge for square watermelons for more economical production of this particular product, which can constantly measure the force exerted during the growth of in different watermelon varieties.

IV. RESULTS AND DISCUSSION

With regard to the experiments, the final draft was modeled and prepared using Solid Works and 3Ds MAX. Experience shows that ordinary Plexiglas molds with a 6 mm thickness and a spring with a 1400N stiffness index.

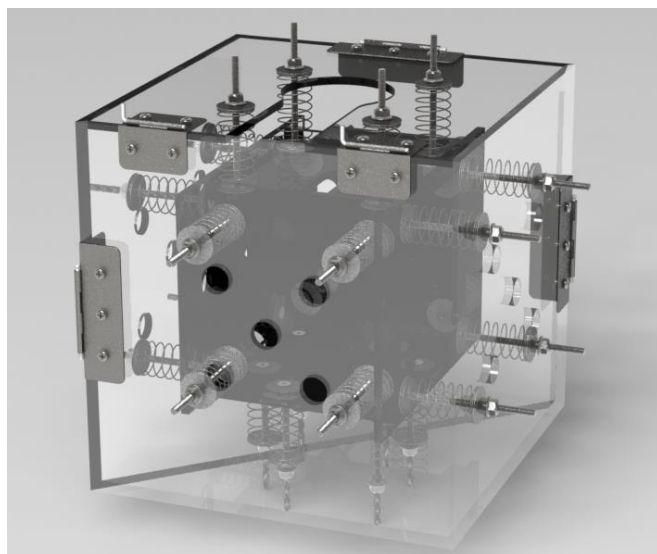

Fig. 2 Mechanical Force Gauge image (by Solid Works)

A mold was tested to assess the gauge performance in Solid Works Analyses under the pressure produced by mold. Results are also reported [9].

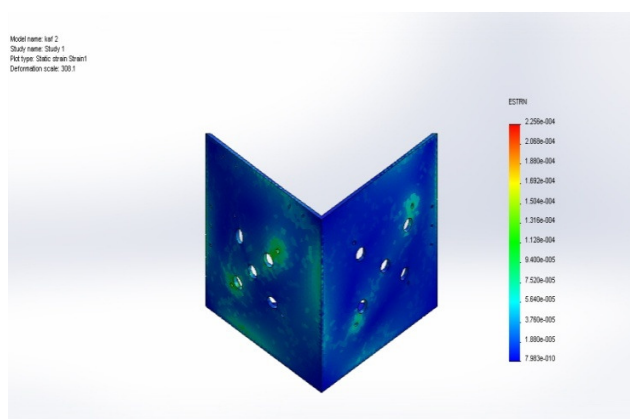

Fig. 3 (a) The outer skin displacement

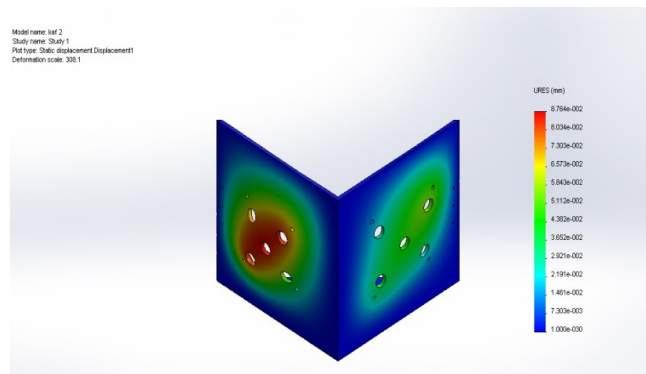

Fig. 3 (b) The outer skin strains

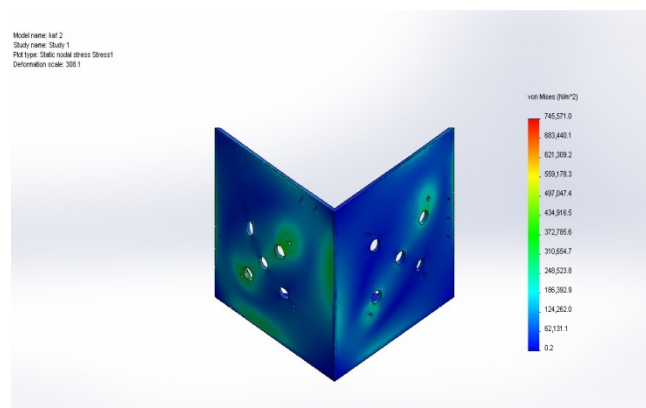

Fig. 3 (c) The outer skin stresses

The outer skin results are as follows:

1. The mold stress distribution was uniform;
2. Naturally, the highest strain and deformation were recorded at springs;
3. The welded edges showed no deformation under pressure; and
4. The selected ventilation had no effect on the plates' strength;

The relation ($F=kX$) was used to determine spring stiffness. To do so, first, the spring length at rest was measured, and then, according to the figures, a given force, F , was imposed. The compressed spring length was also measured. The spring displacement, x , was obtained by subtracting the two spring lengths. Finally, the spring stiffness, K , was calculated using the above relation [10].

This procedure was repeated for all springs. The mean value of all calculated stiffness coefficients was used. As results:

$$X_1 = 5\text{cm} = 0.05 \text{ (m)}, X_2 = 4.4\text{cm} = 0.044 \text{ (m)} \text{ and } F = 12.5 \text{ (N)} \\ \Rightarrow X = X_1 - X_2 = 0.006 \text{ (m)} \quad (8)$$

$$F = kX \quad (9)$$

$$k = F/X = 12.5/0.006 = 2072 \text{ (N/m)} \quad (10)$$

With regard to the designs and considering software analyses, the gauge was developed. For the first step, a Plexiglas sheet with a 6 mm thickness, compression springs

with 1450 N/m stiffness, and pivotal connections were used to develop the pressure gauge. The apparatus was then transferred to an academic test farm with a 500 m² area. Randomly, a watermelon plant was selected and was cautiously place inside the pressure gauge.

Once the watermelon was inside the gauge, it started its operations and spring displacements were recorded. These readings were used to determine force and pressure values.



Fig. 4 The Mechanical Force Gauge photo

TABLE I A
 THE AMOUNT OF REDUCTION IN THE SPRING LENGTH

Spring No.	6-Aug	10-Aug	14-Aug	20-Aug	21-Aug	23-Aug	28-Aug	30-Aug
f1	52	51.8	50.2	48.2	48.2	48	46.6	46.6
f2	52	51.3	51	49.1	49.1	48.8	47.1	47.1
f3	52	50.6	48.5	47.9	47.7	47.2	45.3	44.7
f4	52	51.6	50.4	49.4	49.1	48.9	45.7	45.2
f5	52	51.1	47.4	46.6	46.3	45.9	43.8	43.8
f6	52	49.3	48	46.3	46.3	46	42.2	42.2
f7	52	51.3	48.5	46.2	46.2	45.8	44.8	44.1
f8	52	51.3	50.4	47.6	47.6	46.8	43.3	43.3

TABLE I B
 THE AMOUNT OF SPRING'S COMPRESSION

Spring No.	6-Aug	10-Aug	14-Aug	20-Aug	21-Aug	23-Aug	28-Aug	30-Aug	SUM (mm)
f1	0	0.2	1.6	2	0	0.2	1.4	0	5.4
f2	0	0.7	0.3	1.9	0	0.3	1.7	0	4.9
f3	0	1.4	2.1	0.6	0.2	0.5	1.9	0.6	7.3
f4	0	0.4	1.2	1	0.3	0.2	3.2	0.5	6.8
f5	0	0.9	3.7	0.8	0.3	0.4	2.1	0	8.2
f6	0	2.7	1.3	1.7	0	0.3	3.8	0	9.8
f7	0	0.7	2.8	2.3	0	0.4	1	0.7	7.9
f8	0	0.7	0.9	2.8	0	0.8	3.5	0	8.7

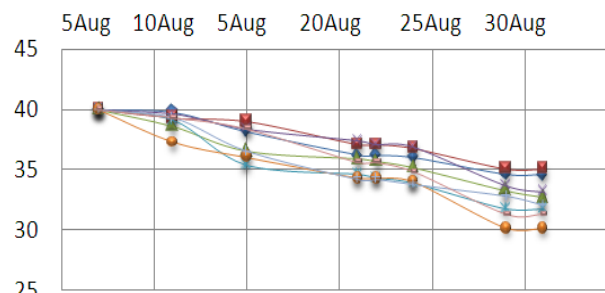

Fig. 5 Changing the spring length than time

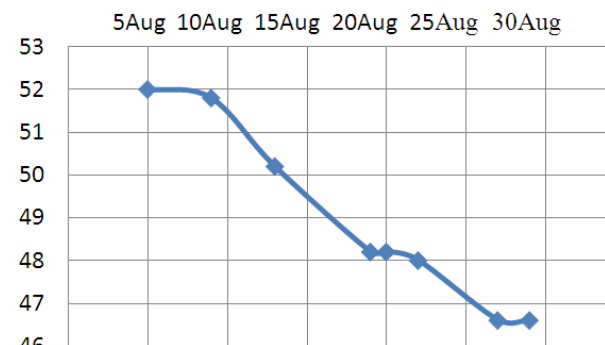

Fig. 6 (a) Changing length of spring number 1

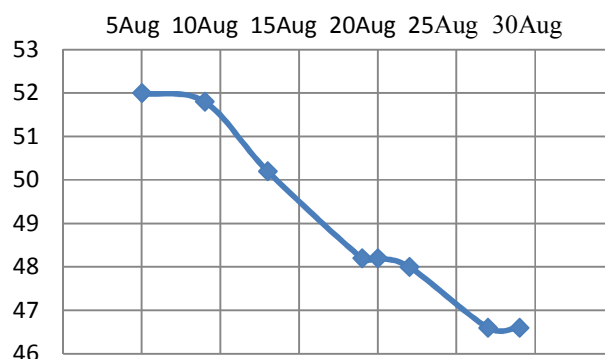

Fig. 6 (b) Changing length of spring number 2

TABLE II
 CALCULATION OF THE FORCE EVERY SPRING

Spring No.	SUM (m)	Spring Stiffness	Force Formula	Force (N)
f1	0.0054	1405.4	F= k.X	7.83
f2	0.0049	1405.4	F= k.X	6.88
f3	0.0073	1405.4	F= k.X	10.25
f4	0.0068	1405.4	F= k.X	9.55
f5	0.0082	1405.4	F= k.X	11.89
f6	0.0098	1405.4	F= k.X	14.21
f7	0.0079	1405.4	F= k.X	11.45
f8	0.0087	1405.4	F= k.X	12.61

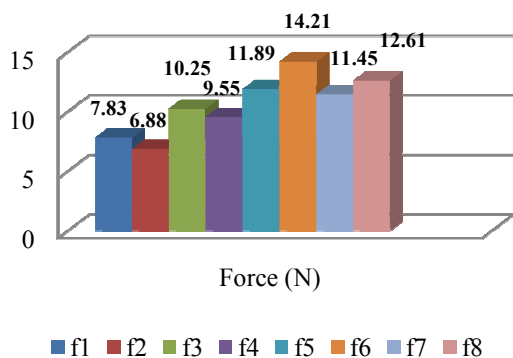

Fig. 7 Amount of Force for each spring

Calculate the maximum pressure inflicted on the mold:
Co-direction springs:

$$x) F_1, F_2, F_3, F_4 \quad (11)$$

$$F' = F_1 + F_2 + F_3 + F_4 = (-7.83) + (-6.88) + 10.25 + 9.55 = 5.09 \text{ (N)}$$

$$y) F_5, F_6, F_7, F_8 \quad (12)$$

$$F'' = F_5 + F_6 + F_7 + F_8 = 11.89 + 14.21 + (-11.45) + (-12.61) = 2.04 \text{ (N)}$$

Calculate the exerted force:

Forces were acting on the surface through four springs with a 0.2 radius.

$$A = \pi r^2 = 3.14 \times (0.2)^2 = 0.1256 \text{ (m}^2\text{)} \quad (13)$$

$$\text{Full area} = A_t = 4A = 4 \times 0.1256 = 0.5024 \text{ (m}^2\text{)}$$

Calculate the pressure exerted on surfaces:

$$P' = \frac{F'}{A_t} = \frac{5.09}{0.5024} = 10.13 \text{ (N/m}^2\text{)} \quad (14)$$

Pressure created by the resultant forces of x-axis springs:

$$P'' = \frac{F''}{A_t} = \frac{2.04}{0.5024} = 4.06 \text{ (N/m}^2\text{)} \quad (15)$$

Pressure created by the resultant forces of y-axis springs:

The maximum pressure was 10.13 N/m² which can be used as a basis for mold development. Based on developed mold, the allowable compression should be 10.5 N/m² along all directions. The desired mold can be now selected according to the modulus of elasticity and stress tolerance of materials.

V. CONCLUSION

- ✓ The ability to measure force and pressure exerted on mold sides during the watermelon growth season;
- ✓ The ability to determine the maximum forces;
- ✓ The ability to draw watermelon growth curves thanks to its ongoing instantaneous force measurements;
- ✓ Matching applied materials to mold development with the physics and conditions required for watermelon growth;
- ✓ High ventilation capability;
- ✓ High transparency for sunlight to reach the watermelon skin (no yellowish skin and quality loss)
- ✓ Fast and straightforward calibration of the pressure gauge;

- ✓ Full assembling and disassembling without any damage to products;
- ✓ Visual check capability during the growth season;
- ✓ Applicable to all watermelon planting environments (including fields, greenhouses, etc.); and
- ✓ Simple calculation of the resultant force based on the gauge engineering.

Moreover, the principles of the designed mold are applicable to other products in order to measure their growth forces. To do so, the mold size and spring stiffness coefficient should be corresponding to the selected fruit [11].



Fig. 8 A watermelon inside the Mechanical Force Gauge in farm

ACKNOWLEDGMENT

The authors would like to thank these agricultural students that helped with the field works: Moein Majnooni Mehrdar, Ali Mohammadi Dolatabadi, Morteza Ramezani, Jaber Zad, Babak Khatar, Ehsan Morteza, M.Amin Nayeri, A.Khaki, R. Songhori, A. Shahriari, F. Sohbat Zadeh, M. Alian, S. Ferdows.

We also express our gratitude to Dr. Sedaghat Hosseini, Mr. Sanei and Mr. Rahimi (the farm managers), Mr. Beheshti, & Dr. Mokhber the Manager of Imam Higher Education Center (IHEC) and Dr. Mir Rahimi the Research Assistant of Center.

REFERENCES

- [1] <http://faostat.fao.org> 2012
- [2] <http://watermelonbenefits.com>
- [3] M. Malek Yarand, H.Saebi Monfared, "The Growth of the Watermelons with geometric shapes ..." WASET Publication, Vol: 7-09002, 2013.
- [4] S.Mustapha Iran Manesh- Morteza Malek Yarand. (2011). Post-harvest Physiology (fruits & vegetable) vol. 1. ITVHE pub...2011. p255
- [5] <http://www.instructables.com/id/Grow-a-square-watermelon>
- [6] S.Mustapha Iran Manesh- Morteza Malek Yarand. (2006). Cold Storage & Stocking the food stuffs vol.(1): fruits & vegetable
- [7] A.Sadr Nia, H. Rajabi "Comparison of physical and mechanical properties of two varieties of watermelon..." Agricultural Engineering Research Journal, vol. 7, fall 2010. p 28-35
- [8] S.B. Navaratne and D.J.S. Subasinghe "Determination of physicochemical properties of Watermelon " European International Journal of Applied Science and Technology Vol. 1 No. 4; June 2014
- [9] SolidWork Userguide Manual software.
- [10] Peter R.N. Childs, Mechanical Design Engineering Handbook, Butterworth-Heinemann pub, 2005.,p 645
- [11] <http://science.kqed.org/quest/audio/building-a-better-tastier-tomato/>