

Natural Ventilation for the Sustainable Tall Office Buildings of the Future

Ayşin Sev, Görkem Aslan

Abstract—Sustainable tall buildings that provide comfortable, healthy and efficient indoor environments are clearly desirable as the densification of living and working space for the world's increasing population proceeds. For environmental concerns, these buildings must also be energy efficient. One component of these tasks is the provision of indoor air quality and thermal comfort, which can be enhanced with natural ventilation by the supply of fresh air. Working spaces can only be naturally ventilated with connections to the outdoors utilizing operable windows, double facades, ventilation stacks, balconies, patios, terraces and skygardens. Large amounts of fresh air can be provided to the indoor spaces without mechanical air-conditioning systems, which are widely employed in contemporary tall buildings.

This paper tends to present the concept of natural ventilation for sustainable tall office buildings in order to achieve healthy and comfortable working spaces, as well as energy efficient environments. Initially the historical evolution of ventilation strategies for tall buildings is presented, beginning with natural ventilation and continuing with the introduction of mechanical air-conditioning systems. Then the emergence of natural ventilation due to the health and environmental concerns in tall buildings is handled, and the strategies for implementing this strategy are revealed. In the next section, a number of case studies that utilize this strategy are investigated. Finally, how tall office buildings can benefit from this strategy is discussed.

Keywords—Tall office building, natural ventilation, energy efficiency, double-skin façade, stack ventilation, air conditioning.

I. INTRODUCTION

IT is a well-known fact that the built environment is a significant contributor to global environmental problems and greenhouse gas emissions, which are the primary reasons for the climate change in our era. Unfortunately buildings are accountable for 30-40% of the world's total energy consumption [1], and carbon emissions in buildings have been increasing at an annual rate of 2% between 1971 and 2004 [2]. Fast urbanization is not the only reason for constructing more and more tall buildings; there are other social, economic and also environmental reasons, such as increasing land prices in city centers, green land preservation, global competition, emerging technologies, human aspirations and ego with the growing economic status, are named to be a few. Although there seems to have many environmental and social disadvantages, tall buildings are inevitable for our modern global cities due to their many benefits. It is a well-known fact that a tall building is very intensive in energy and resource

consumption, not only during the construction phase, but also during its operation, as well. But also a tall building may have more opportunity than a regular building type to involve contemporary technologies to lower down its environmental impact, since it is a huge investment with a large budget. In this context, many researchers are now investigating tall buildings in order to reduce their primary energy consumption, enhancing the sustainability of this building type. A sustainable design approach to tall buildings will be a positive contribution to sustainability in order to decrease the environmental impacts by means of energy consumption, enhancing the health, comfort and productivity of the occupants by improving the indoor environmental quality.

One of the efficient strategies to improve the environmental quality and enhance occupant health and comfort in tall office buildings is to re-introduce natural ventilation strategies, since it is an important portion of energy consumption. According to the database of US Department of Energy, the Heating, Ventilating and Air Conditioning (HVAC) systems in tall office buildings, which are built after 1980 across 16 US cities of various climates, typically account for 33% or more of overall building energy consumption [3]. The increased efficiency in these systems, especially for heating, cooling and ventilating by passive means, is the most important single step in making tall buildings more sustainable. Although the initial examples of tall buildings were naturally ventilated through operable windows, by the introduction of curtain wall systems, mechanical ventilation and air-conditioning after the World War II, many of the tall buildings rely on mechanically ventilation today. However, due to the extensive energy use and health problems of mechanical air conditioning systems, today the re-introduction of natural ventilation is inevitable.

The elimination, or even the reduction, of the reliance on mechanical ventilation systems, and incorporation of natural ventilation strategies in order to enhance the sustainability of tall office buildings is the focus of this paper. For this purpose, it will be beneficial to look through the energy performance and ventilation strategies of tall buildings through a historical point of view. Following this historical review, natural ventilation strategies will be presented and a number of tall office buildings will be investigated. Finally, how tall office buildings can benefit from natural ventilation strategies, as well as options and limitations will be presented.

A. Sev and G. Aslan are with the Faculty of Architecture, Mimar Sinan Fine Arts University, Istanbul, Turkey (phone: 212-252 1600; e-mail: aysinsev@yahoo.com, gorkem.canc@gmail.com).

II. HISTORICAL EVOLUTION OF VENTILATION IN TALL BUILDINGS

A. First Generation of Tall Buildings with Natural Ventilation

Without any doubt, the tall building typology is the invention of 19th century due to rapid urbanization and urgent necessity for working spaces in city centers. Although the tall building did not exist until the 19th century, Pevsner [4] in his *History of Building Types*, awards the first office building to the Uffizi, which was built in the center of the old city of Florence between 1560-81 and the architects at that time encountered similar difficulties as the architects of office buildings experienced today [5]. By the mid-19th century, due to migrations from rural to urban areas and population growth, tall buildings quickly spread across North American cities. Being awarded to be the first high-rise by the Council on Tall Buildings and Urban Habitat (CTBUH), Home Insurance Building (1885) in Chicago is a remarkable example of this new phenomenon. This first generation of tall office buildings mostly reflected the styles of classical architecture, and based on designs that can be traced back to antiquity and shared characteristics of Italian palaces of the Renaissance and the Roman houses, which were described in Vitruvius' *The Ten Books on Architecture* [6]. The quality of internal environment in these early office buildings was provided largely by design principles, such as plan form and depth from the façade, story height, and fenestration and glazing area. Operable windows and shades in hot seasons, as well as the utilization of stoves or radiators during cold seasons ensured protection from extreme weather conditions. These buildings consequently required little operating energy as technologies, such as mechanical air-conditioning was not developed yet [7]. Providing natural light for working spaces were of utmost importance and also a design constraint, generating shallow floor plans. The need to provide adequate daylight limited the depth of office floor plans, and this design constraint also enabled natural ventilation via operable windows.

In the first examples of tall office buildings natural ventilation was common not only for the purpose of supplying fresh air, but also for sanitary reasons and for reducing the excessive humidity, which was a major problem in masonry buildings of that era. Due to the common design practices, consisting of open central atriums and light wells surrounded by office spaces, the floor plan depths were inherently limited leading to an efficient fresh air supply to the indoors. This was also a result of planning constraints to provide adequate daylight to the workspaces. Keeping cool was not a major concern, however, the elimination of excessive humidity was a significant problem that has to be solved with the help of efficient natural ventilation.

B. Second Generation of Tall Buildings and Introduction of Mechanical Ventilation

By the end of the 19th century, tall office buildings were mostly designed with light courts or in E-, H-, and U-shapes in order to provide adequate daylight, and also having very large plot areas [5]. Although the basic need to provide

daylight was a constraint for the office building, another significant problem appeared to be the odor due to the humidity and it signaled the need for an efficient ventilation to supply adequate fresh air. As a result mechanical ventilation was necessary to provide comfortable indoor environment for new larger and taller buildings. Meyer [8], after visiting many office buildings, stated in his article that, the odor was a significant sign that supported the necessity of ventilation [5].

By the beginning of the 20th century, most prominent tall office buildings were designed on the basis of providing daylight and natural ventilation. Built in 1924, the Strauss Building in Chicago was a remarkable example for having a large central core; however, many iconic buildings such as the Chrysler Building (1929) and the Empire State Building (1930) were not designed to have light courts, and also did not have any strategy for natural ventilation.

Although the first modern electrical air-conditioning unit was invented by Willis Carrier in 1902, its utilization did not become widespread until 1950s. The development of air conditioning in offices languished for the next 20 years. By the mid-1920s, air-conditioning was installed in theatres, hotels and department stores, but rarely in office buildings. Tall office buildings of the era, such as the Woolworth Building (1913), the Chrysler Building (1929) and the Empire State Building, all reached unprecedented heights without benefiting from mechanical air conditioning. In 1928 the first full installation of air conditioning system was for the Milam Building in San Antonio, Texas. This building was the first in the country to be completely equipped for air conditioning to provide comfort through the year. Although air-conditioned, the form, fenestration, floor plans can be referred to the pre-air conditioning era [5]. Although all of the office workers were not satisfied with the air conditioning of this building and they needed to open the windows due to the inefficiency of the system and poor air distribution, they were considerably better than the buildings that were not equipped with air conditioning.

This first invention of Willis Carrier controlled not only temperature, but also humidity as well. His technology was applied to increase productivity in the workplace and over time air conditioning came to be used to improve comfort not only in office buildings, but also in homes and automobiles in the 1950s. Air conditioning in office buildings was becoming increasingly common until the World War II interrupted construction. Buildings without operable windows were being built through the country. By the 1950s, many of the formerly built tall office buildings were installed with mechanical air conditioning afterwards, in order to take the benefit of mechanical ventilation.

The availability of cheap energy and the widespread use of the new mechanical ventilation system had a significant impact on the planning of tall office buildings after the World War II. Controlling indoor air temperature and humidity by mechanical means eliminated the design constraints such as limited plan depth and window areas. Consequently natural ventilation became an old fashion. The reliance on air conditioning enabled deep-planned, transparent, fully glazed

facades, also influenced by the International Style of the era. High-rises, such as Seagram Building (1958) in New York and IBM Building (1972) in Chicago were all clad with glass curtain walls with no shading devices, and also fully air-conditioned to cool down the working places during the summer and heating during the winter [9].

C. Oil Crisis of 1970s and the Third Generation of Sealed Tall Buildings

The energy crisis that emerged in 1973 and 1979 caused an interruption in the design of tall buildings with fully single-glazed curtain walls. As the environmental problems arose, many nations brought building energy performance codes, consequently necessitating passive design strategies and high performance façade systems, such as double-glazing windows, and etc. [10]. One adverse effect of the fully air-conditioned and sealed office buildings that drew attention was the sick building syndrome, which was a result of humidity and growth of mold through the air-conditioning devices and ducts. The inefficiency in providing adequate fresh air to indoors and overheating problems in summer affected the productivity and performance of office workers, thus demanding new approaches in the ventilation and air-conditioning of forthcoming office buildings by the end of 1980s and 1990s.

D. Energy Efficient Tall Buildings with the Re-Introduction of Natural Ventilation

In the search for new approaches for designing energy efficient tall buildings with healthy and comfortable indoor environments, new principles were improved. These principles were not new in fact, rather a revival of the traditional approaches, such as natural ventilation to provide fresh air inside via open courts, atriums, and operable windows, as applied in the first generation of tall buildings. However, most of the contemporary tall buildings did not enable natural ventilation through operable windows due to their ultra-heights, as the former buildings did. Although many literature awards Commerzbank (1997) designed by Norman Foster in Frankfurt, as the first naturally ventilated tall building [11]-[14], Gordon Bunshaft's National Commercial Bank in Jeddah, Frank Lloyd Wright's Price Tower in Oklohama, and Ken Yeang's bioclimatic skyscrapers can be stated as the previous examples of the modern era [15]. A number of remarkable examples of the recent era will be investigated in detail in the following sections.

III. NATURAL VENTILATION PRINCIPLES AND STRATEGIES FOR TALL OFFICE BUILDINGS

Natural ventilation, which is the process of supplying fresh air and removing it through an indoor space without using any mechanical devices in order to dilute and exhaust pollutants, is often an element of green or sustainable architecture. [16]. Tall buildings being a large segment of high-tech contemporary architecture, can benefit from natural ventilation by reducing operation energy, (as well as

construction energy, due to installing the devices), and more importantly by providing healthy and comfortable indoor environments for occupants. Provision of fresh air and a connection to the outdoors, which are the main requirements of natural ventilation, can be achieved by operable windows, double facades, ventilation stacks, balconies, patios, terraces, atriums and gardens in a tall building [17]. Occupants can control and increase fresh air provision as needed. Depending on the climate, as well as personal preferences, cooling loads, or at least ventilation loads can be reduced.

Although there is some research into providing improved natural ventilation to residential tall buildings [18], most of the research was conducted for the investigation of natural ventilation for tall office buildings. Over the last years, a number of naturally ventilated tall office buildings have been built and evaluated using double facades [19]. It is extremely rare for a tall office building to be able to rely completely on natural ventilation, due to the implications of failure of the system. There is only one completed building, the Torre Cube in Guadalajara, which is fully naturally ventilated without any mechanical plant for heating, cooling or ventilation. The building is 17 stories tall and takes great advantage of the compliant Guadalajara climate [9], as will be investigated in the forthcoming section.

In the following subsections, principles and strategies for natural ventilation, either solely or in mixed-mode, are presented.

A. Principles of Natural Ventilation in Tall Office Buildings

Generally speaking, the physical mechanisms for natural ventilation in a tall building are the same with ordinary buildings, relying on pressure differences generated across the envelope openings. The pressure differences are generated by:

- i. the effects of wind;
- ii. temperature differences that also cause differences in air density;
- iii. a combination of both.

In this context, natural ventilation can be classified into "wind-driven" and "buoyancy-driven" ventilation according to the physical mechanism, which drives the air. Wind-driven ventilation can be classified as cross ventilation and single-sided ventilation, and depends on wind behavior, on the interactions with the building envelope and on openings or other air exchange devices such as inlets or chimneys.

The climatic characteristics of the urban space, such as the wind around the building, is crucial when evaluating the air quality and thermal comfort inside as air and heat exchange depends on the wind pressure on facades. The pressure effect of the wind on the building is primarily determined by the building's shape, the wind direction and velocity, and influence of the surroundings, which are the factors determining the pressure coefficient. In addition, the mean pressure difference across a building's envelope is dependent upon the mean wind velocity at upper levels of the building, and the indoor air density as a function of atmospheric pressure, temperature and humidity [9]. Computational Fluid Dynamics tools and zone modellings are usually used to

design naturally ventilated buildings. Some of the important limitations of wind-driven ventilation can be stated as;

- Unpredictability and difficulties in harnessing due to speed and direction variations,
- The quality of air it introduces in buildings may be polluted, for example due to proximity to an urban or industrial area,
- May create a strong draught, discomfort.

Buoyancy-driven ventilation, also known as the stack-effect or chimney-effect, occurs due to differences between the density of interior and exterior air, which mostly results from differences in temperature. When there is a temperature difference between two air volumes, the warmer air will have lower density and be more buoyant, thus will rise above the cold air creating an upward air stream. The pressure differences generated by buoyancy are mainly dependent on the stack height or the height difference between air intakes and extract openings, and the air density difference as a function of temperature and moisture content in the air.

In order for a building to be ventilated adequately via buoyancy-driven ventilation, the inside and outside temperatures must be different so that warmer indoor air rises and escapes the building at higher apertures. If there are lower apertures, then colder and denser air from the exterior enters the building through them, thereby creating up flow displacement ventilation. However, if there are no lower apertures present, then both in- and out-flow will occur through the high level openings. This latter strategy still results in fresh air reaching to low level, since although the incoming cold air can be designed to mix with the interior air, it will always be denser than the bulk interior air and hence fall to the floor. Buoyancy-driven ventilation increases with greater temperature difference, and increased height between the higher and lower apertures in the case of displacement ventilation. When both high and low level openings are present, the neutral plane in a building occurs at the location between the high and low openings at which the internal pressure will be the same as the external pressure (in the absence of wind). Above the neutral plane, the air pressure inside will be positive and air will flow out of any intermediate level apertures created. Below the neutral plane the air pressure inside will be negative and external air will be drawn into the space through any intermediate level apertures [20]. Buoyancy-driven ventilation has several significant benefits as stated below [21]:

- Does not rely on wind, and can take place on hot summer days when it is most needed;
- Stable air flow (compared to wind) can be obtained;
- Greater control in choosing areas of air intake can be provided;
- Limitations of buoyancy-driven ventilation can also be stated as follows:
- Lower magnitude compared to wind ventilation on the windiest days
- Relies on temperature differences (inside/outside)
- Design restrictions (height, location of apertures) and

may incur extra costs (ventilator stacks, taller spaces)

- The quality of air it introduces in buildings may be polluted for example due to proximity to an urban or industrial area (although this can also be a factor in wind-driven ventilation)

Natural ventilation in buildings can rely mostly on wind pressure differences in windy conditions, but buoyancy effects can augment this ventilation and ensure airflow rates during still days. Buoyancy-driven ventilation can be implemented in conditions, when air inflow in the building does not rely solely on wind direction. In this respect, it may provide improved air quality in some types of polluted environments such as cities. For example air can be drawn through the backside or courtyards of buildings avoiding the direct pollution and noise of the street facade. Wind can augment the buoyancy effect but can also reduce its effect depending on its speed, direction and the design of air inlets and outlets. Therefore prevailing winds must be taken into account when designing for buoyancy-induced ventilation.

It should be noted that a reverse buoyancy effect could occur when outside air temperature is significantly higher than internal building temperature. In such a circumstance air can enter a tall building at upper levels and discharge from lower levels. This reverse effect can be difficult to manage.

Although the wind- and buoyancy-driven natural ventilations can occur separately, they are more likely to occur at the same time. Thermal buoyancy will generally dominantly occur in a calm and temperate day, as wind-driven ventilation will need a windy day.

B. Strategies of Natural Ventilation in Tall Office Buildings

The design of a tall office building with the task of achieving efficient natural ventilation for energy performance and occupant comfort is a strenuous process, in which engineering disciplines must also involve. According to Ethridge and Ford [22] The Chartered Institution of Services Engineers (CIBSE) Application Manual AM10 2005 [23] is a comprehensive design guidance, which designers can benefit from for tall office buildings. According to this guide, natural ventilation is a difficult task to achieve, especially for tall buildings in city centers, however it is not impossible. External noise and pollution are often cited as reasons for adopting mechanical systems. Even if filtration and mechanical ventilation are essential, the principles of high thermal capacity and night ventilation can provide an effective low-energy cooling system, providing fan power loads are minimized through careful design.

The ventilation strategies are closely related with how air is taken into a building and how it is extracted. The different strategies, which are similar to a low-rise building is as follows:

- Single-sided ventilation* occurs, where fresh air is taken into and exhausted from the space through the same opening. In order for this strategy to work, the depth of the space must be a maximum of 2.5 times its actual height (Fig. 1). The driving force is mainly the wind;

however, buoyancy effect can also help if the openings are located at different heights.

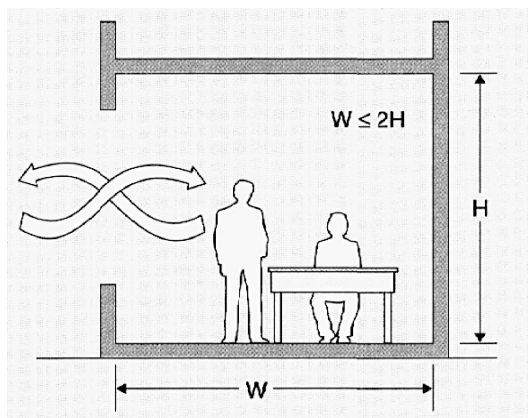

Fig. 1 Single-sided ventilation [27]

- ii. *Cross-ventilation* occurs, where there is a pressure differential between the two sides of a building's envelope involving openings. In this case the air moves from the windward to the leeward side of the building. For an effective cross-ventilation, the depth of the ventilated space must not exceed 5 times of its height (Fig. 2). As in the single-sided ventilation, buoyancy effect can help to enhance its efficiency.

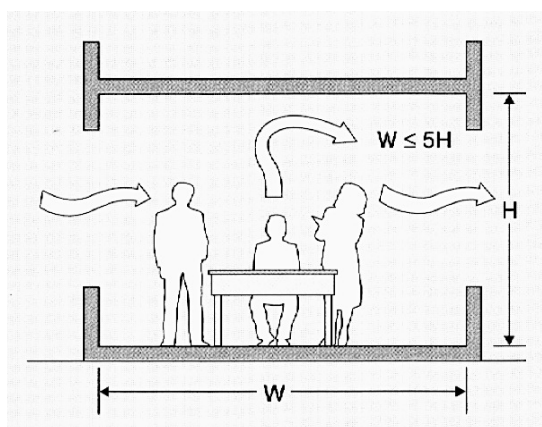

Fig 2 Cross-ventilation [27]

- iii. *Stack-ventilation* occurs, where the fresh air is taken into the building from a low level and exhausted from a high level through a (chimney-like) stack due to the temperature and pressure differences between the interior and exterior, or certain zones within the building (Fig. 3). This effect can be provided in buildings with an atrium, chimney or a double façade.

Unfortunately, there are precious number of cases that benefit solely from natural ventilation due to the local site and climatic conditions, as stated before. For example, in extreme climates, such as hot and/or humid or extremely cold regions, providing health and comfort for occupants cannot be possible only with natural ventilation. In this case mechanical systems must be installed to aid the ventilation, as well as to cool the

spaces in hot and humid zones. This is a *mixed-mode* or *hybrid ventilation* strategy, which is applied in most of the tall office buildings in Europe.

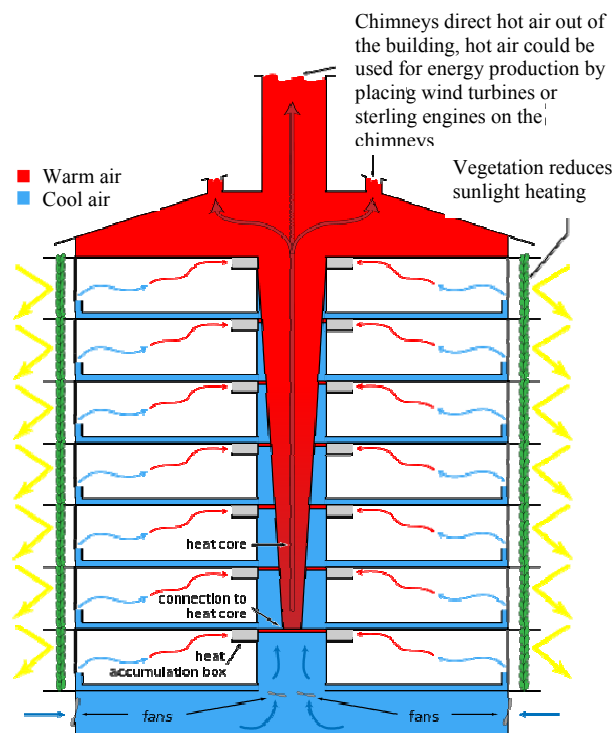

Fig 3 Stack effect for natural ventilation in tall buildings [20]

Mixed-mode ventilation strategies are typically classified according to their operation modes, whether the two strategies operate in the same or different times, or at the same or different times. As such this classification can be stated as follows [9]:

- i. *Contingency*; where the building is designed as an air-conditioned or as a naturally ventilated building with the electrical infrastructure available. According to the conditions, it is ventilated mechanically or naturally solely;
- ii. *Zoned*; where mechanical or natural ventilating is applied in different parts or zones, which are isolated from each other;
- iii. *Complementary*; where the building is ventilated mechanically and naturally at the same time with changing loads depending on the outdoor or indoor conditions.

Buildings with mixed-mode ventilation strategies generally necessitate sophisticated Building Management Systems (BMSs), which will control the outdoor and indoor conditions, operate the operable parts of the façade (openings, shadings, and etc.) and regulate the loads of the natural and mechanical ventilation and air-conditioning.

Natural ventilation strategies for a tall office building can also be categorized based on the connections between the various spaces of the building [22]. The spaces can be designed entirely in isolation from each other or having a

connection between them in terms of airflow. In buildings with *isolated spaces*, the openings to other parts of the building must be small in relation to openings in the external envelope (Fig. 4). Spaces A and B are examples of single-sided ventilation, with a large single opening and two small openings at different heights. Spaces C and D are examples of cross flow ventilation with large and small openings. In both cases the flow pattern results from the action of wind alone. Space E shows the flow pattern due to buoyancy alone.

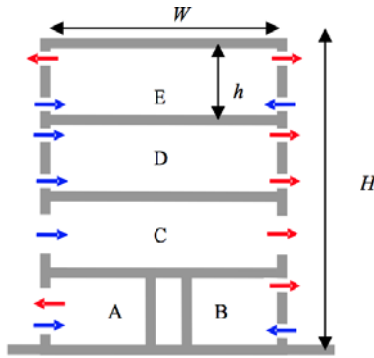

Fig. 4 Ventilation patterns for isolated spaces in a building [22]

This approach has a significant design constraint that the width to height ratio of the building is limited. It is commonly assumed that cross flow ventilation of a space is only effective for $W/h < 5$, as stated above. If this ratio is too big, some areas of the space may not be ventilated. If one takes the limiting value of W/h to be 5, say, the aspect ratio, H/W of a 10-storey building will need to be greater than 2, but for a tall building with 50 stories it will need to be greater than 10. A possible way round this problem is to divide each floor level into several isolated spaces, e.g. in the form of pods [22].

Another problem arises from the high wind pressures that can be encountered, whereas the buoyancy pressures remain low, because they are determined by h . This leads to large differences between the open areas required to achieve the flow rates under wind alone and buoyancy alone conditions. [24].

In the other approach, the spaces in a building are connected by large internal openings, leading to the flow of air through a central duct, stack, e.g. and atrium (Fig. 5). Such spaces are relatively common in naturally ventilated buildings, partly to minimize internal resistance to flow and partly to enhance internal mixing. The atrium is used to generate inward flow of fresh air into all of the occupied floors. An advantage of this strategy is that wind and buoyancy will act together, if the outlet opening is in a region of relatively low wind pressure and the indoor temperature is higher than the outdoors.

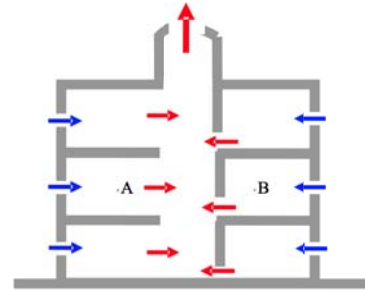

Fig. 5 Ventilation patterns for connected spaces via an atrium [22]

For tall buildings, the main problem of this approach arises from the high-pressure differences that can be generated by buoyancy, due to the height of the building. The building in this case acts as a single space, and its overall height determines the buoyancy force, which can threaten the comfort and safety of the occupants by causing problems in opening doors and windows. This problem can be solved by designing the building in segments, or in other words, installing internal resistances in the form of segmentations through the height of the stack or atrium (Fig. 6). This strategy is also applied in Commerzbank. This approach is a challenge due to the aerodynamic effects around the outlet of segments; in this case axi-symmetric venturi approach can be applied to overcome this problem [25].

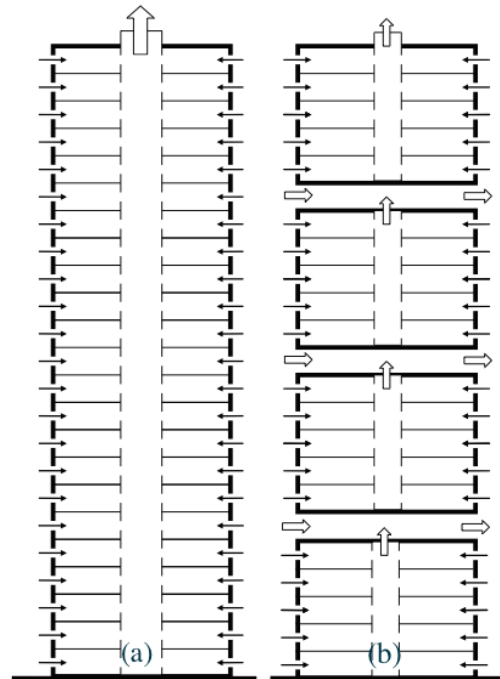

Fig. 6 Segmentation of a tall building for an efficient and reliable natural ventilation; (a) Atrium without a segmentation; (b) Atrium with a segmentation [22]

IV. CASE STUDIES WITH NATURAL VENTILATION STRATEGIES

Although it is a common belief that tall office buildings cannot be naturally ventilated due to their immense height there readily exist many high-rises, which are naturally ventilated during the most of the year, even an example located in a moderate climate, which relies on solely natural ventilation throughout the year. Some of these examples are designed to have double-skin facades to enable efficient natural ventilation, whereas a number of examples do not need double-skin façade to be naturally ventilated. In this section buildings ventilated naturally throughout the year are investigated, highlighting their ventilation strategies.

A. The State Ministry of Urban Development and the Environment, 2013, Hamburg

The complex consists of a 13-story high-rise and several five-story low-rises, which are recently completed in Hamburg. Being one of the most energy-efficient buildings of Germany, the complex employ natural ventilation via a single-skin façade with the help of operable sashes and ventilating flaps (Fig. 7). Here, each façade module possesses a manually operated triple-glazed sash, as well as a lateral ventilation flap of insulated aluminium. The ventilation flaps are placed behind the metal cladding on the outer side for protection from the high wind speeds. Consequently, fresh air is taken in without any wind and rain effect [26]. In addition to relying on cross-ventilation strategy for office spaces throughout the year, the complex also takes the benefit of geothermal heating during the winter.

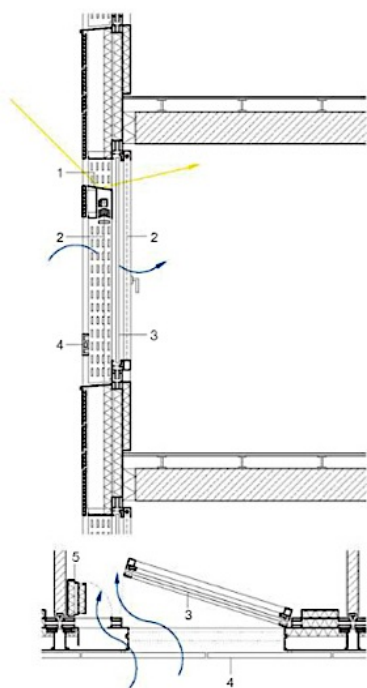

Fig. 7 The single-skin façade detail of the State Ministry of Urban Development and the Environment, Hamburg; 1-daylight control; 2-solar protection; 3-triple-glazed operable window; 4-ceramic profile guard rail; 5-ventilation flap [26]

B. Deutsche Bank Twin Towers, 2010, Frankfurt

Deutsche Bank's Head Office, the 155 m tall Deutsche Bank Twin Towers in Frankfurt have undergone a major renovation thus making the towers one of the most environmentally friendly skyscrapers in the world. These renovated green towers received the LEED platinum certification and the Gold Medal of German Sustainable Building Council after the refurbishment. The energy consumption was reduced by 50% and the CO₂ emissions by nearly 90%.

In the renovation project, high quality indoor environments and satisfaction of workplace conditions was one of the important aspects; and the most efficient strategy for this task was benefiting from natural ventilation strategies, with a high-performance façade design. The new super insulated triple-paned windows can keep the heat out in summer, as well as reducing heat loss in winter. As every second operable windows are opened, thus necessitating lesser air to be moved through mechanical ventilation, increasing the energy efficiency of the towers. Each window is motor operated and opens outward projecting 180 mm from the façade (Fig. 8). To achieve an effective application, a new hardware is developed by the designer to resist high wind loads. The air intake from these windows can be controlled individually or centrally, responding to different occupant profiles.

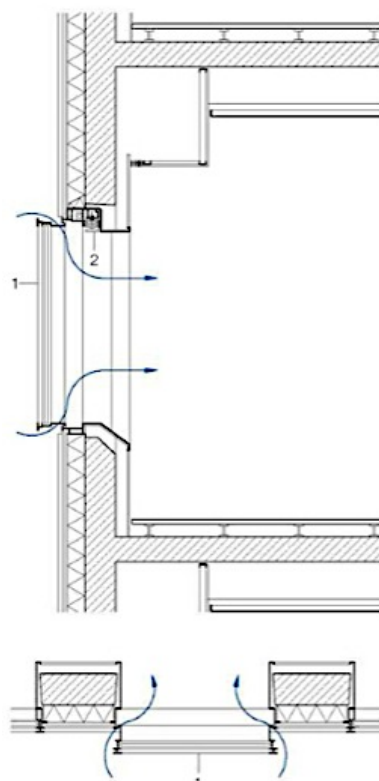

Fig. 8 The single-skin façade with fixed glazing and parallel ventilation windows applied in Deutsche Bank Twin Towers in Frankfurt; 1-triple-glazed operable ventilation windows; 2-solar protection and light control louvres [26]

When wind or rain is strong, windows close automatically, or when solar radiation is excessive, the BMS overrides the settings, to reduce the thermal gain, thus closing the windows on the appropriate side. At night windows open automatically to help nighttime cooling in summer. This strategy, not only significantly contributes to the energy efficiency, but also provides occupants' satisfaction as well [26].

C. ADAC Headquarters, Munich

The 92 m high ADAC Headquarters in Munich is another energy efficient, sustainable office building, taking advantage of natural ventilation by the help of a double-skin façade, which consists of 1152 modules of various curves due to a curved plan form. Each façade module on the inner skin is story-high and equipped with two operable windows, as well as an operable ventilation flap. The outer layer consists of a baffle plate with ventilated cavity (Fig. 9). The office floors are designed to have no partition, thus making it problematic with regard to natural ventilation during windy days. The façade flaps ensure that the air-exchange rate is constant, thus reducing the energy consumption of mechanical air conditioning. Air passes through the unit's four valves for intake air, exhaust air, fresh air and outgoing air. During the strong winds the control unit operates quietly and independently, requiring no auxiliary energy, when pressure difference is minimal, the air automatically passes through the control unit [26].

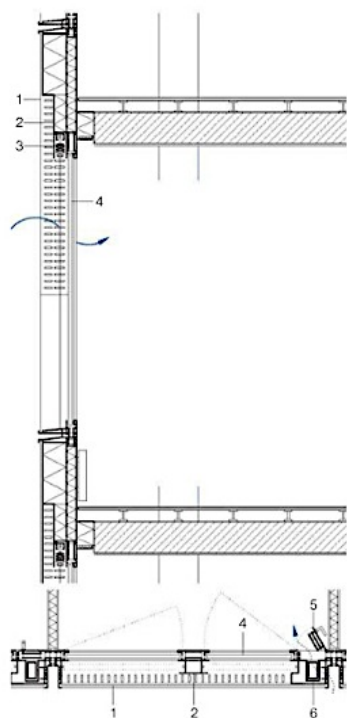

Fig. 9 The double-skin façade with baffle plate, ventilation flaps and volume-flow control in ADAC Headquarters, Munich; 1-baffle plate; 2-aluminium sheet; 3-solar protection; 4-triple-glazing; 5-ventilation flap; 6-volume-flow control [26].

D. Commerzbank Headquarters, 1997, Frankfurt

Commerzbank Headquarters in Frankfurt is a 259 m tall office building, and designed to reduce the environmental impacts of a contemporary building of this scale. Being one of the most ecologic high-rises in the world, the tower has a triangular plan with an atrium of the full height, which is separated into four segments with glass and steel diaphragms [15]. The office floors are stacked in groups and skygardens are designed between these office floors, which are also called 'villages' by the designer. The spiralling configuration of villages and skygardens between them enhance the natural ventilation strategy, whereas the segmentation of the atrium limits stack pressure within the atrium (Fig. 10). The triangular plan form and different location of villages and skygardens also enable natural ventilation regardless of the wind direction. Depending on the wind direction, generally the fresh air moves up the atrium, however, sometimes it moves downward, which is a difficult problem to solve. The role of the skygardens is not only to help natural ventilation strategy, but also to serve as a social space for the office workers, as well.

The design strategy for the Commerzbank is mostly developed according to the German planning regulations, which forces all the workplaces to have direct access to daylight by being positioned not deeper than 7 meters. Consequently the workplaces are designed on the two sides of a corridor, one side facing the exterior, and the other facing the atrium, having a total width of the workplaces 16.5 meters. The external facing offices are ventilated through a double-skin façade, which is composed of a solid pane of laminated glass on the outer, also deflecting from strong winds and rain. The 200 mm cavity between the inner and outer skin is ventilated at the top and bottom via 125 mm continuous slots in the external skin. Small aerofoil section strips are positioned at sill levels just above and below these ventilation slots to improve air flow through the cavity.

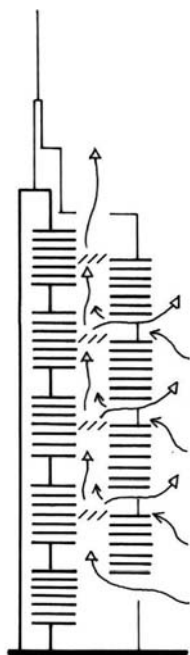

Fig. 10 Diagram showing the natural ventilation strategy for Commerzbank, Frankfurt [28]

In the workplaces, the double-glazed windows in the inner skin open inwards at the top with an angle of maximum 15°, thus allowing fresh air to move indoors. The double-skin façade acts mostly as a buffer control wind-driven air into the office space and partly as a thermal flue by stack buoyancy.

The atrium-facing offices are ventilated via air moving through the sky gardens. Each 14 m high sky garden façade has large motorized pivoting windows at the bottom for air intake and top for air extraction. The ventilation strategies for outer facing, atrium facing and corridors all operate independent from each other. As a result, the outer offices can ventilate naturally all year-round, all of the offices are single-sided ventilated, the atrium is cross-ventilated also with the aid of stack-ventilation.

When the natural ventilation strategy cannot be applied due to the extreme weather conditions (although it works more than 60 % of the year) mechanical systems help to ventilate the building in extreme weather conditions. Sky gardens always remain naturally ventilated and intermediate in temperature between the interiors and exterior. During summer, when it is too hot, natural ventilation is not allowed. The BMS also controls the internal environmental conditions during extreme weather conditions and also depending on the number of occupants. It also determines the level of occupants' control [9]. Since 2002, the satisfactory conditions in the offices meant that the control of the windows of the atrium-facing offices were left to the occupants rather than the BMS, as they were used to opening the windows for natural ventilation. Interestingly, with more individual control, occupants were more tolerant to internal summer temperatures of higher than 26°C, and preferred these thermal conditions rather than closing the windows and disabling natural ventilation [29].

E. Post Tower, 2002, Bonn

The Post Tower, completed in 2002 in Bonn, is an energy efficient and environmentally conscious office building with its 42 floors and 163 m height. The floor plan is consisted by offsetting the two halves of an ellipse and by replacing the office areas along the perimeter of this elliptical plan, and also an inner atrium of 7.2 m wide is placed in the center of the plan with core areas by the two sides of this atrium. The tower is designed to take the benefit of natural ventilation with the help of a double-skin façade and this atrium.

The double-skin facades on the north and the south faces both consist of a laminated single-glazed outer skin and an argon-filled double-glazed inner skin. The cavity, with a varying width of 1.7 m on the south and 1.2 m on the north, is segmented vertically coherent with the partitions of the atrium at every nine floors and 11 floors at the top. The outer skin protects the motorized single-hunged operable windows on the inner skin from high wind speeds at the upper levels (Fig. 11). Through the stack effect within each part of the cavity operable flaps draw in cooler air from the lower level, and exhaust hot air from the upper level. During winter these flaps are closed as much as possible and the cavity acts as a thermal buffer. Occupants can open their window whenever they need fresh air regardless of the outer weather conditions, since the flaps are controlled by the BMS.

The overall ventilation strategy relies on both cross-ventilation in office spaces and stack-ventilation in the atrium. During extreme weather conditions in summer and winter, thermal comfort in the offices is provided by the help of mechanical ventilation system via fan-coil units and radiant ceilings [9].

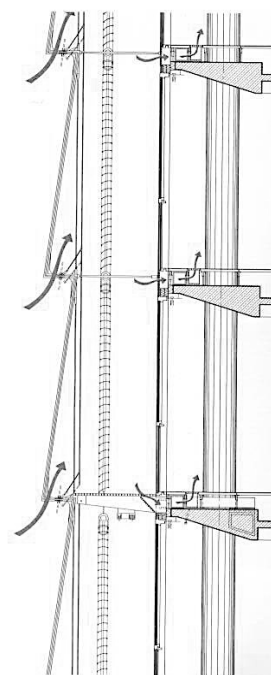

Fig. 11 Section detail showing the operable flaps of Post Tower on the south façade [9]

F. Highlight Towers, 2004, Munich

Highlight Towers in Munich consist of two slender skyscrapers placed 20 meters apart from each other and connected with a bridge. The towers have parallelogram floor plans with a small footprint in order to ensure that each and every part of the work places have direct access to daylight and air. The bridges are conceived as clip-on elements and can be disconnected from the towers to be attached to another level.

The towers are naturally ventilated through a single-skin façade of 1.35 m wide typical modules, which consist of a 950 mm triple-glazed fixed glass panel and a 400 mm hinged window panel. The narrow operable windows feature an exterior perforated stainless steel panel that provides sun protection as well as rain and wind. The side-hinged windows can be electronically opened inward on each floor and can be controlled individually for an efficient natural ventilation. When windows are opened, fresh air is intaken through the fixed perforated panels. Exhausted air passes through a sound-insulated overflow unit into the central corridor, then directed through auxiliary rooms (Fig. 12). A control panel is installed for each office unit for the individual control of not only natural ventilation and thermal conditions, for also lighting level as well.

Since there is no conventional central mechanical ventilation and air extraction system, the necessity for mechanical floor is also eliminated leading to an increase in usable floor space. Occupants have a high degree of direct control over the indoor environmental conditions through the operable windows and room control panels, enhancing the thermal comfort of office workers [9].

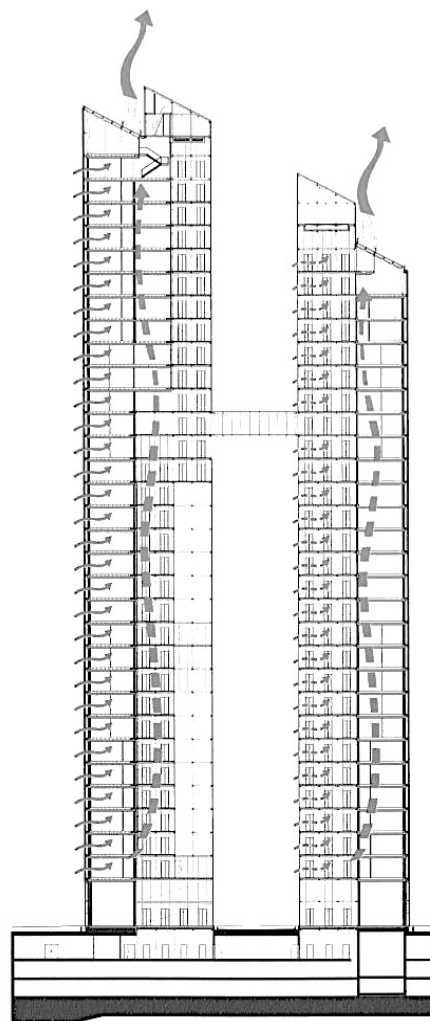

Fig. 12 Building section of Highlight Towers in Munich. Each office is directly ventilated from pivoting panels in the exterior façade. Exhaust air is directed through an overflow unit at the ceiling level and sent to shafts to be discharged from the building [9]

G. Torre Cube, 2005, Guadalajara

Torre Cube is a 60-m tall office tower located in Guadalajara, which has a humid sub-tropical climate, featuring dry, mild winters and warm, wet summers. The most remarkable feature of this office building is that, it is the only office building of this scale, which relies on solely natural ventilation during the year. The tower consists of three funnel-shaped, timber clad office wings cantilevered from three concrete cores (Fig. 13). The office spaces have a maximum depth of 12 m depth and an average of 12 m width. The office wings and three service cores are located around the central open void (similar to an atrium), which functions as a light well, also acting as an important part of the natural ventilation strategy. The mild climate enables natural ventilation throughout the year without reliance on mechanical ventilation, heating or cooling. The office wings have an external skin of open rain screen/brise-soleil façade of wooden latticework and inner skin of floor-to-ceiling high sliding windows. The outer skin also acts as a buffer against

wind-driven ventilation when wind speed is high.

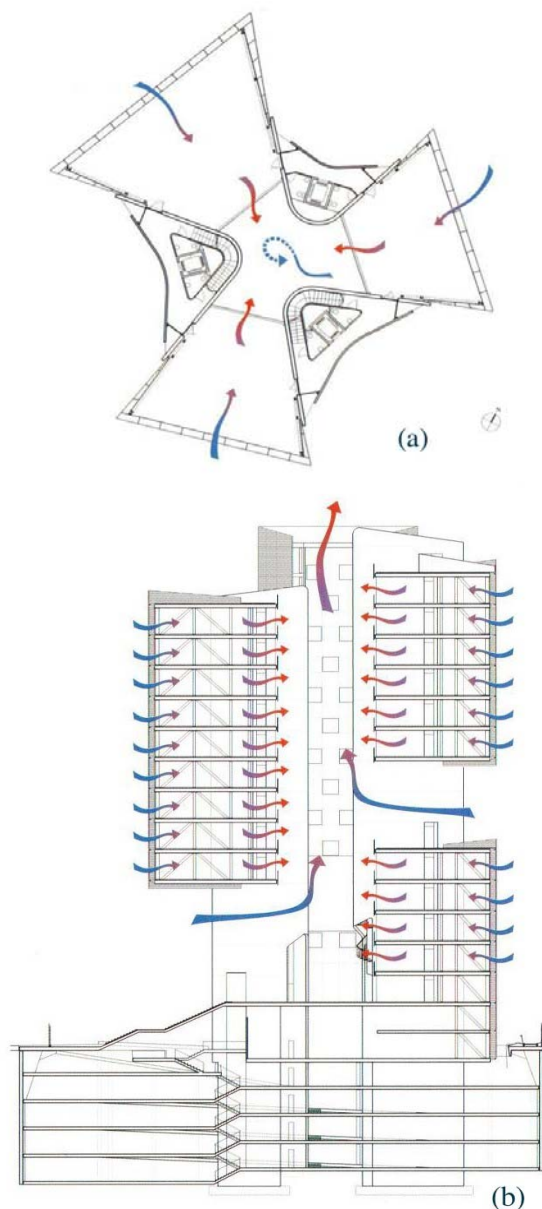

Fig. 13 (a) Typical office floor plan and (b) building section showing the natural ventilation strategy of Torre Cube in Guadalajara [9]

The inner and outer skins in the office tower can be both operated manually. Fresh air enters the office spaces through sliding glass windows in the façade, and then exhausted into the central void via stack effect. Skygardens also enhances this stack effect also helping the natural ventilation both in summer and winter. During winter, climate is mild enough to eliminate the need for heating [9].

H. San Francisco Federal Building, 2007, San Francisco

San Francisco Federal Building is a slender 18-story office building with a narrow rectangular plan located along the northeast and southwest axis, in order to benefit from the prevailing wind for the natural ventilation strategy. By this

approach minimal cooling is needed during extreme summer conditions. Due to the security reasons for the Federal Building, the base levels cannot be opened for air intake, thus making the lower five floors fully sealed. Cross-ventilation strategy is employed without any double-skin façade detailing in isolated office floors. Wind enters the building from operable windows of the windward façade and is exhausted from the opposite side (Fig. 14).

On the top of the building the façade module is designed as an operable window, which is controlled by the BMS. In the office floors, windows can be operated by the occupants manually to allow greater individual control of ventilation. As the temperatures decrease dramatically at night in San Francisco, the concrete structure provides excellent source for night cooling [30].

The building has high-performance double-glazed low-E glass with an improved solar heat gain coefficient. Both façades have shading devices to minimize heat gain in the offices. The glazing of the northwest façade is protected by a series of fixed translucent vertical sunshades, while the glazing of the southeast façade is protected from solar glare and heat gain by a perforated metal sunscreen.

The open plan office spaces above the fifth floor are designed to be naturally ventilated 100% of the time; however, this area accounts for only approximately 21% of the usable area of the whole office building [9].

V. CONCLUSION

This study is a part of a Master of Science thesis, which has just initiated. The investigation of case studies will be broadened, and results will be enhanced following the comparison of the examples according to a number of criteria.

The primary purpose of natural ventilation in buildings is to provide a comfortable, healthy indoor environment and adequate air quality, as well as reducing the energy consumption of mechanical ventilation systems. Although there is a common belief that tall office buildings cannot be ventilated naturally due to their immense height and wind velocity at the high levels, the number of examples, which utilize natural ventilation are remarkable. Therefore it is important to understand the aspects of natural ventilation principles and strategies.

Possibility and efficiency of natural ventilation for a tall office building largely depends on the climatic conditions of the site. Natural ventilation strategies can be derived according to general climatic classifications, such as tropical, hot dry, temperate and cold. As different climates pose different environmental requirements, various design strategies can be designed to achieve occupant comfort. Depending on the characteristics of the site, the most dominating driving force must be determined; then the ventilation strategy of the building must be designed. In the regions of cold climate central ventilation inlets and outlets will be advantageous in order to utilize heat recovery systems, since the most important consideration is to conserve heat, or prevention of heat loss. In mild climates, local inlets and outlets will be effective for an efficient natural ventilation.

Devices, such as high thermal insulation, passive heating during the cold season and sun control elements must be adapted to the architectural design, which must be conducted according to daily, seasonal and yearly variations of climatic conditions. Wall-to-floor ratio, window-to-floor ratio and building orientation are also important aspects for an efficient design. Double-skin facades with operable windows has become a common strategy for natural ventilation, however, this approach must be carefully analyzed to prevent an adverse effect, such as overheating in hot seasons. If the cavity is not sufficiently ventilated and/or sunshading devices are not properly positioned, the façade of the building can experience overheating.

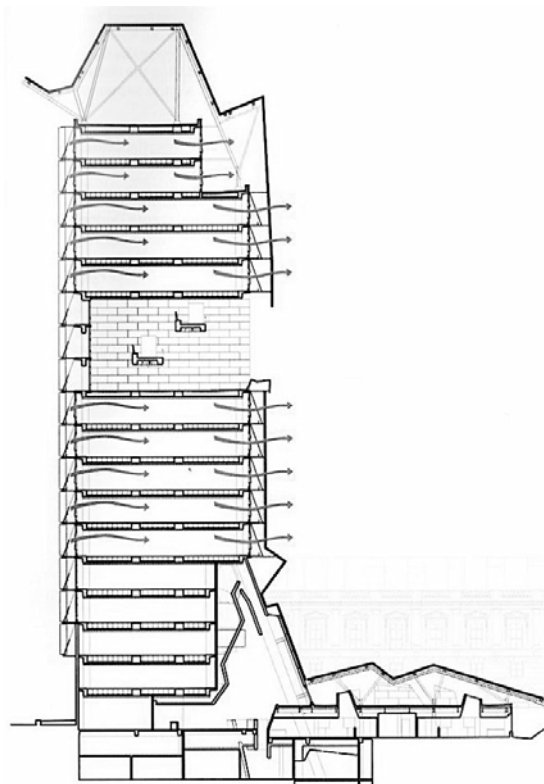

Fig. 14 The building section of San Francisco Federal Building showing the natural ventilation strategy [9]

The use of sky gardens, atriums and voids through the height of tall office buildings also has become a common design approach, since they enhance the stack effect for an efficient natural ventilation. Stack effect is a complex problem for a tall building, and must be studied carefully. When the atrium and shafts are the only sources of fresh air to the working spaces, segmentations must be designed in order to reduce the airflow through these atriums.

Although the number of tall office buildings, solely relying on natural ventilation, is very few, in the future, by the help of greater investigations, this number will increase. Adopting natural ventilation is necessary not only to increase the indoor environmental quality; it is also needed to increase the energy performance of buildings, as well as to satisfy office workers.

REFERENCES

- [1] United Nations Environmental Programme (UNEP), "Buildings and Climate Change", available online: <http://www.unep.org/Documents.Multilingual/Default.asp?DocumentID=502&ArticleID=5545&l=en>, 2007, Accessed on April 2014.
- [2] M. Levine, D. Ürge-Vorsatz, K. Blok, L. Geng, D. Harvey, S. Lang, G. Levermore, A. Mongameli Mehlwana, S. Mirasgedis, A. Novikova, J. Rilling, H. Yoshino. Residential and commercial buildings. In *Climate Change 2007: Mitigation. Contribution of Working Group III to the Fourth Assessment Report of the Intergovernmental Panel on Climate Change*, B. Metz, O.R. Davidson, P.R. Bosch, R. Dave, L.A. Meyer (eds)), Cambridge: Cambridge University Press, 2007.
- [3] A. Wood, "Sustainability: A new high-rise vernacular?", *The Structural Design of Tall and Special Buildings*, 16, 2008, pp. 401-410.
- [4] N. Pevsner, N. *A History of Building Types*. Princeton: Princeton University Press, 1976.
- [5] D. Arnold, "Air Conditioning in Office Buildings after World War II", *ASHRAE Journal*, July 1999, pp. 33-41.
- [6] P. Vitruvius, *The Ten Books of Architecture*, Translated by Morris Hickey/Morgan. Dover Publications Inc, 1960.
- [7] P. Oldfield, D. Trabucco, A. Wood, "Five energy generations of tall buildings: an historical analysis of energy consumption in high-rise buildings", *The Journal of Architecture*, 14 (5), 2009, pp. 591-613.
- [8] H. C. Meyer, "Some points regarding the ventilation and the heating of tall buildings", *ASHVE Transactions*, 15, pp. 94-107.
- [9] A. Wood, R. Saliba, *Natural Ventilation in High-Rise Office Buildings*, New York: Routledge, 2013.
- [10] T. E. Johnson, *Low E-Glazing Design Guide*, Massachusetts: Butterworth Architecture, 1991.
- [11] M. Pepchinski, "With its naturally ventilated skin and gardens in the sky, Foster and Partners' Commerzbank reinvents the skyscraper", *Architectural Record*, 186 (1), 1998, pp. 68-79.
- [12] I. Lambot, C. Davies, *Commerzbank Frankfurt: Prototype of an Ecological High-Rise*, Surrey: Birkhauser, (1997).
- [13] National Commerce Bank, *Emporis.com*, available online: <http://www.emporis.com/building/nationalcommercebank-jeddah-saudi-arabia> Accessed on June 2014.
- [14] V. Fischer, R. Richter, *Norman Foster: Commerzbank Frankfurt am Main*, Stuttgart: Axel Menges, 1998.
- [15] A. Sev, *Sürdürülebilir Mimarlık*, Istanbul: YEM Yayın, 2009.
- [16] T. Kleiven, *Natural Ventilation in Buildings: Architectural Concepts, Consequences and Possibilities*, Doctoral Dissertation, Norwegian University of Science and Technology, 2003.
- [17] P. Irwin, J. Kilpatrick, J. Robinson, A. Frisque, "Wind and tall buildings: Negatives and positives", *The Structural Design of Tall and Special Buildings*, 17, 2008, pp. 915-928.
- [18] R. Priyadarsini, K. W. Cheong, N. H. Wong, "Enhancement of natural ventilation in high-rise residential buildings using stack system", *Energy and Buildings*, 36 (1), 2004, pp. 61-71.
- [19] T. Pasquay, "Natural ventilation in high-rise buildings with double facades, saving or waste of energy", *Energy and Buildings*, 36 (4), 2004, pp. 381-189.
- [20] J. McWilliams, "Review of air flow measurement techniques", LBNL Paper LBNL-49747, Lawrence Berkeley National Laboratory.
- [21] P. F. Linden, "The Fluid Mechanics of Natural Ventilation". *Annual Review of Fluid Mechanics*, 31, 1999, pp. 201-238.
- [22] D. W. Ethridge, B. Ford, "Natural ventilation of tall buildings – options and limitations", *CTBUH World Congress*, 3-5 March, 2008, available online: www.ctbuh.org Accessed on June 2014.
- [23] Chartered Institution of Building Services Engineers, *Natural ventilation in non-domestic buildings*, Applications Manual 10, CIBSE, London, 1997.
- [24] P. S. Jahnkassim, K. Ip, "Energy and occupant impacts of bioclimatic high rises in a tropical climate", *Proceedings of PLEA 2000, Architecture, City, Environment*, London: James and James, 2000, pp. 249 – 250.
- [25] S. Daniels, J. Stoll, G. Pultz, J. Schneider, *The skyscraper: naturally ventilated?* Report by E. Top, European Consulting Engineering Network, 1993.
- [26] B. Rudolf, "Breathing facades: façade technology toward decentralized, natural ventilation", *Detail*, 2012 (5), English Ed., 2012, pp. 512-517.
- [27] *Natural Ventilation in Non-Domestic Buildings*, Good Practice Guide 237, available online: <http://www.cagbc.org/AM/PDF/GoodPracticeGuide237.pdf>, Accessed on April 2014.

- [28] A. Sev, *Türkiye’de ve Dünyadaki Yüksek Binaların Mimari Tasarım ve Taşıyıcı Sistem Açısından Analizi*, Doctoral Dissertation, Mimar Sinan University, Institute of Science and Technology, Istanbul, 2001.
- [29] J. Gonçalves, K. Bode, “Up in the air”, *CIBSE Journal*, December, 2010, pp. 32-34.
- [30] E. McConahey, P. Haves, T. Christ, “The integration of engineering and architecture: a perspective on natural ventilation for San Francisco Federal Building”, in *2002 ACEEE Summer Study on Energy Efficiency in Buildings*, American Council for an Energy Efficient Economy: Washington DC, 2002, pp. 239-352.

Aysin Sev (Assoc. Prof. Dr.), born in Istanbul in 1971, earned the architecture degree in Mimar Sinan University in 1994. After completing her MSc degree in building technologies in the Science and Technology Institute of the same university, she earned her doctoral degree on high-rise building technologies in 2001. She was granted with Associate Professor degree in 2010. Currently she is a lecturer at the Building Technology Department of Faculty of Architecture in Mimar Sinan Fine Arts University, an performing scientific researches on sustainable building technologies and high-rise buildings as well. She is the writer of two books entitled Load Bearing Systems in Multi-Storey High-Rise Buildings (with Prof. Aydan Özgen) and Sustainable Architecture, which are both published nationally in Turkish.

Görkem Arslan (Res. Asst.), born in Bolu, 1987. She graduated from Golden Horn University, Faculty of Architecture, Department of Architecture in 2008. She received her first MSc degree from Bahcesehir University, Institute of Science and Technology. She worked as a Research Assistant in the Department of Architecture, Faculty of Architecture and Design in Bahcesehir University between 2010-2013. She was assigned to the Department of Architecture of Faculty of Architecture in Mimar Sinan Fine Arts University as a research assistant. She is studying her second MSc degree in Mimar Sinan Fine Arts University, Institute of Science and Technology.