

Microstrip Slot Antenna for Triple Band Application in Wireless Communication

Biplab Bag

Abstract—In this paper, the design of a coaxial feed single layer rectangular microstrip patch antenna for three different wireless communication band applications is presented. The proposed antenna is designed by using substrate Roger RT/duroid 5880 having permittivity of about 2.2 and tangent loss of 0.0009. The characteristics of the substrate are designed and to evaluate the performance of modeled antenna using HFSS v.11 EM simulator, from Ansoft. The proposed antenna has small in size and operates at 2.25GHz, 3.76GHz and 5.23GHz suitable for mobile satellite service (MSS) network, WiMAX and WLAN applications. The dimension of the patch and slots are optimized to obtain these desired functional frequency ranges. The simulation results with frequency response, radiation pattern and return loss, VSWR, Input Impedance are presented with appropriate table and graph.

Keywords—Microstrip, Tangent Loss, MSS, WiMAX, WLAN, Radiation Pattern, Return Loss, VSWR.

I. INTRODUCTION

In recent years microstrip antenna have been one of the most researchable and innovative idea in antenna theory. The microstrip antennas have a number of useful features such as low profile, light weight, conformal shaping, low cost, and simplicity of manufacturing and easy integration to microwave circuit board [1]. Beside the advantages, it has some disadvantages and one of the major disadvantages is narrow bandwidth and the researcher are try to increase bandwidth.

The radiating patch may be square, rectangular, circular, and triangular. Out of these the rectangular patch is by far most widely used configuration [2]. It is easy to analyze by transmission line model. Single band patch antenna can be modified into a dual band, triple band or multiband antenna by introducing slots in the patch at appropriate position. The shape and position of the slots play an important role in determining the resonance frequency [3]. When the slot is cut either quarter wave in length or half wave in length at an appropriate position inside the patch, it excite the another mode near the fundamental mode of the patch and that gives us dual or multi frequency response [4].

IEEE802.16 working group has established worldwide Interoperability for Microwave Access (WiMAX) technology [5] and IEEE 802.11 standard has set Wireless Local Area Network [6] and mobile satellite service [7] has been operated in the proposed antenna. Several authors [8]-[12] have focused

B.Bag is with the Department of Electronics and Instrumentation Engineering of Murshidabad College of Engineering and Technology, Berhampore, West Bengal, Pin-742103, India (phone:+919434641391; e-mail:bbagate@gmail.com).

on patch antenna for WiMAX and WLAN applications on their own way.

In this article the proposed antenna resonant frequencies are 2.25GHz for MSS, 3.76GHz for WiMAX and 5.23 for WLAN and their corresponding return loss are -18.73dB,-19.77dB and -22.85dB respectively. The 10dB bandwidths are 50MHz (2.23GHz-2.28GHz), 150MHz (3.72GHz-3.87GHz) and 430MHz (5.08GHz-5.51GHz). The slots are adjusted with various attempts to improve the parameter like return loss, radiation pattern, VSWR. All data are obtained by simulation using Ansoft HFSS v.11 and the dimensions of the patch are calculated by simple MATLAB programming.

II. ANTENNA STRUCTURE

The schematic diagram of proposed antenna is shown in Fig. 1. The dimension of the rectangular patch is 46mm x 33.8mm (W x L). The substrate for this antenna is Roger RT/duroid 5880 with dielectric constant is 2.2, dielectric tangent loss is 0.0009 and the height of the substrate $h=3.5$ mm. A 50 ohm input impedance coaxial fed radius is 0.6mm at a point (0,-5) where the centre of the patch is consider at a point (0, 0). The coaxial probe fed is very easy fabricate and match with low spurious radiation.

The size of the ground plane is taken to be more than six times of the substrate thickness in all direction with respects to the patch dimension so the effect is realize as an infinite ground plane.

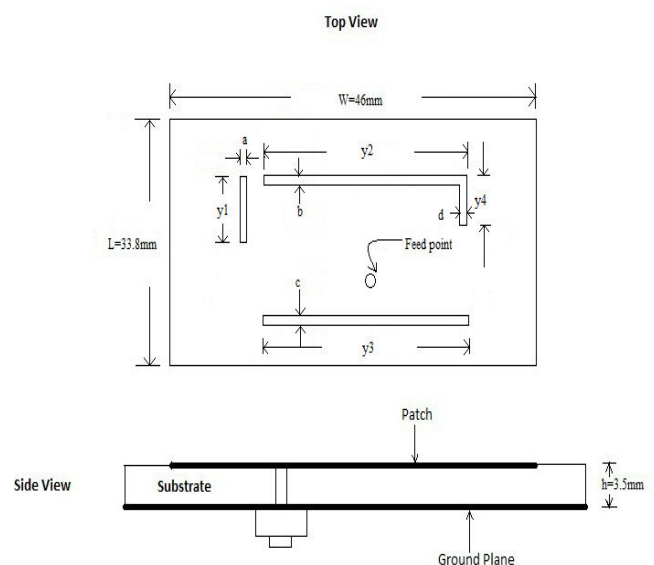

Fig. 1 Schematic diagram of proposed antenna

TABLE I
OPTIMAL PARAMETER VALUE OF THE ANTENNA

Antenna Parameter	Units
y1	9mm
y2	26mm
y3	26mm
y4	07mm
a	0.5mm
b	0.5mm
c	0.7mm
d	0.7mm

mm = Millimeter

Fig. 2 shows the proposed antenna configuration with optimal value which is same patch size 46mm x 33.8mm (W x L) and similar substrate.

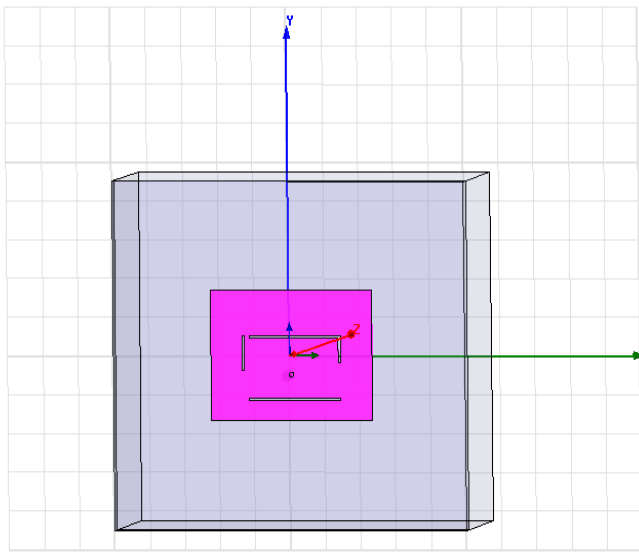

Fig. 2 Proposed antenna configuration

III. SIMULATED RESULT

This section describes the simulated results of proposed antenna. The simulated result is carried out by the help of HFSS v 11 EM simulator. The Return Loss, VSWR, Radiation Pattern for three resonant frequency of proposed antenna are illustrating in Figs. 3 (a)-(e). For the proposed antenna resonant frequencies are 2.256GHz and 3.769GHz and 5.23GHz with return losses are -18.73dB, -19.77dB and -22.85dB respectively. The simulated 10dB bandwidths are 47 MHz, 147MHz and 439MHz respectively and VSWR \leq 2dB. Hence introduce a slots can achieved desirable resonant frequencies. All the parameter changes mentioned in the graphs are in millimeter (mm).

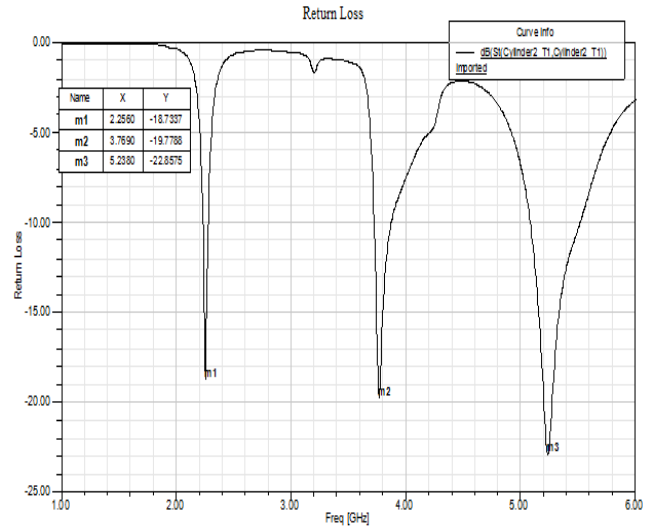

Fig. 3 (a) Simulated return loss for proposed antenna

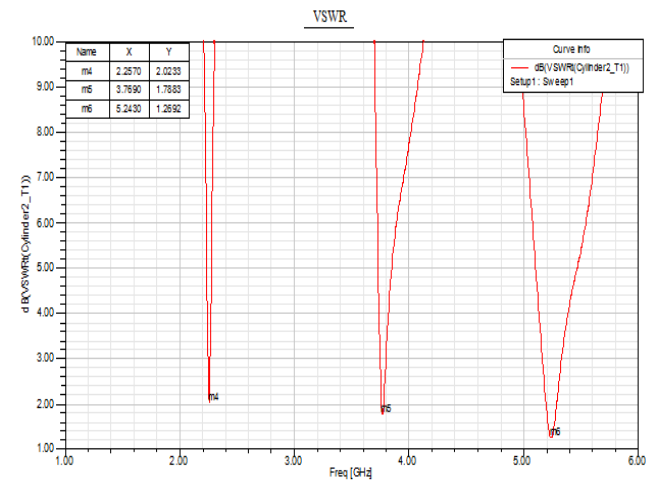

Fig. 3 (b) VSWR of proposed antenna

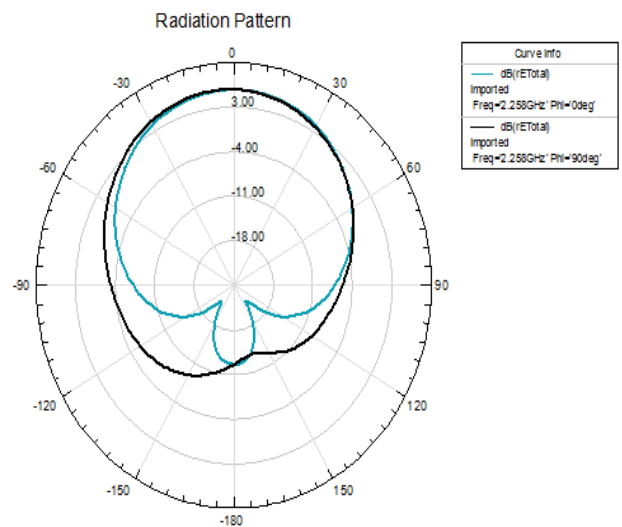

Fig. 3 (c) Simulated radiation pattern at 2.256 GHz

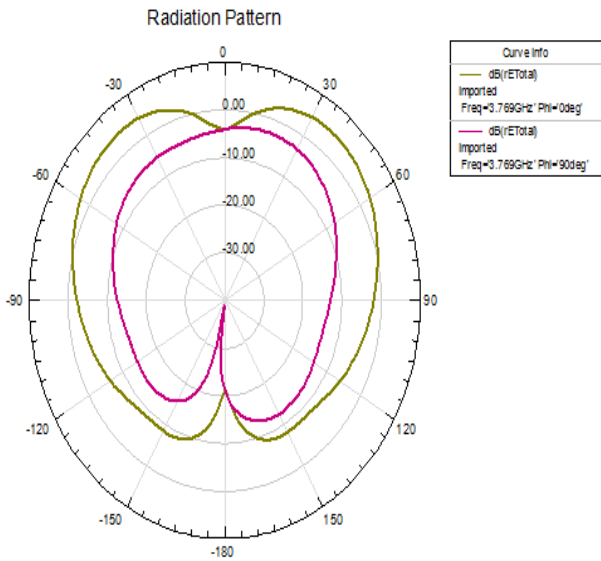

Fig. 3 (d) Simulated radiation pattern at 3.769 GHz

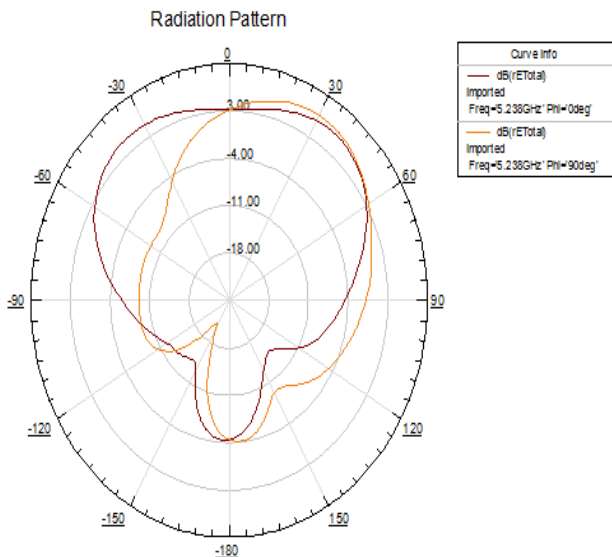

Fig. 3 (e) Simulated radiation pattern at 5.238 GHz

A. Effect of Parameter 'a', 'b', 'c' & 'd'

In the proposed antenna first fixed the value of 'y1', 'y2', 'y3' & 'y4' at optimal, the width of the slots 'a', 'b', 'c' and 'd' varies simultaneously. The simulation results are depicted in Fig. 4. When 'a', 'b', 'c' and 'd' are increases the upper resonant frequency shift away to higher value and increase return loss, on the other hand for decrease the width of the slots the return loss of first resonant frequency drastically high. Also second resonant frequency decrease < -10dB.

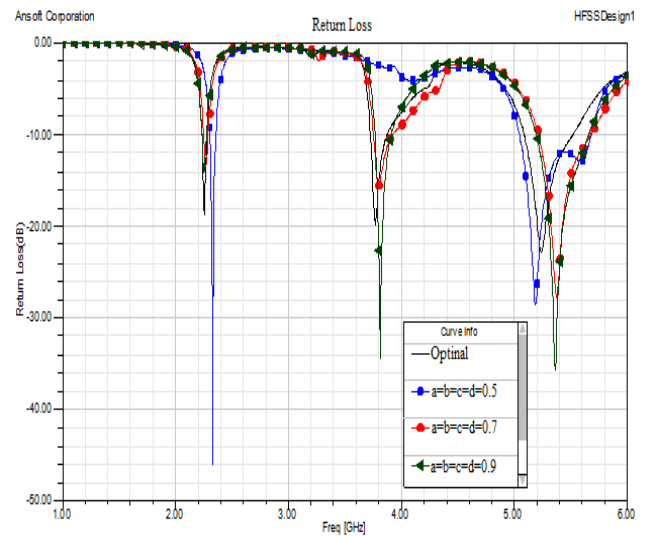

Fig. 4 Simulated return loss for different values of 'a', 'b', 'c', 'd'

B. Effect of Parameter 'y1'

Now fixed the value of 'y2', 'y3' and 'y4' at 26mm, 26mm and 7mm respectively the simulation result are display in Fig. 5. Whenever 'y1' changed from optimal value the upper resonant frequency shifted away the band which is clearly depicted Fig. 5.

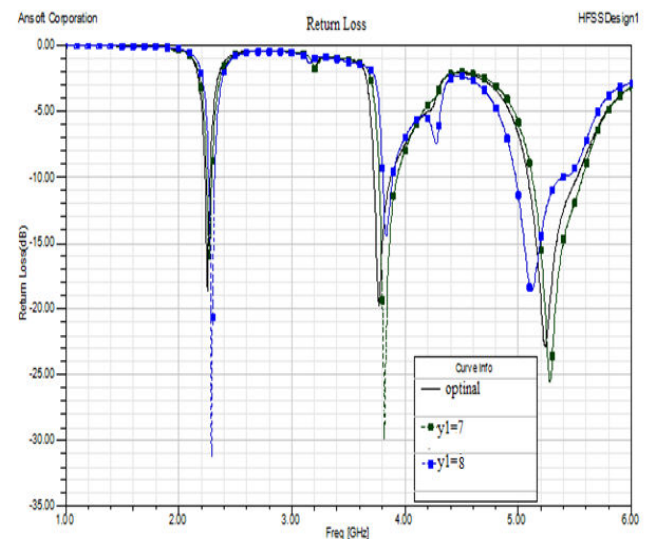

Fig. 5 Simulated return loss for different values of 'y1'

C. Effect of Parameter 'y4'

In Fig. 6 shows how middle band resonant frequency is shifted due to small alter the length of 'y4' from the optimal value at 7mm. Not only that the upper resonant frequency also decrease from the optimal value. But lower band does not affect significantly by varying 'y4'.

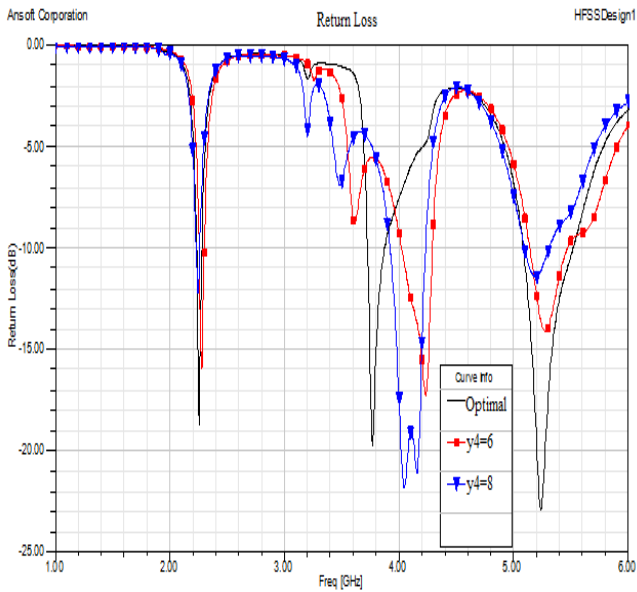

Fig. 6 Simulated return loss for different values of 'y4'

D. Effect of Parameter 'y2' & 'y3'

Fig. 7 shows the effect of variation of the length 'y2' & 'y3' simultaneously on simulated return loss. It is observed that with increase of 'y2' & 'y3', the first resonant frequency does not change significantly but second resonant frequency increase abruptly. It is also clearly shows that slight decrease 'y2' & 'y3', the upper resonant frequency shifted away from desire band.

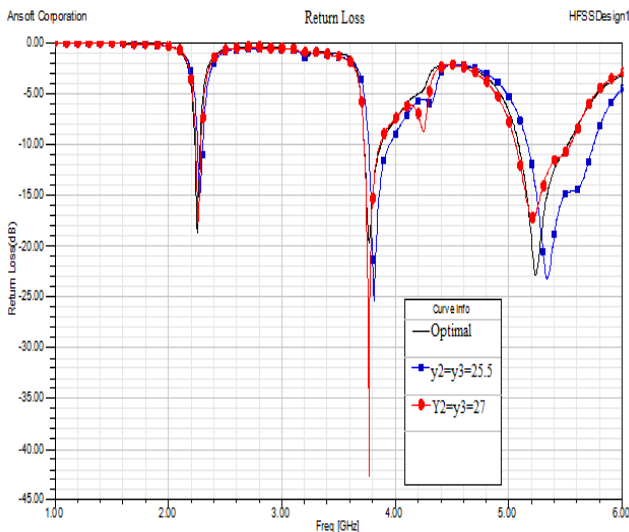

Fig. 7 Simulated return loss for different values of 'y2' & 'y3'

IV. CONCLUSION

In this paper, single coaxial fed single layer slotted microstrip antenna has been proposed. The proposed antenna can operated in triple bands. The resonant frequency can be tuned by changing the slots length. The location and length of the slots are optimized in such a way that the antenna can operate in suitable band. It has been shown that the proposed

patch antenna produced bandwidth of approximately 2.12%, at 2.25GHz, 4% at 3.76GHz and 8.5% at 5.23GHz the corresponding VSWR are 2.02, 1.85 and 1.27 respectively. The bandwidth can be enhanced by changing the slots length and position but the effect would be reflected on VSWR and resonant frequency which are different from the desired frequency band. The proper impedance matching of proposed antenna can be achieved by adjusting the coaxial feeding structure.

REFERENCES

- [1] Balanis C.A. (2005) Antenna Theory: Analysis and Design, John Wiley & Sons.
- [2] Girish Kumar, K. P. Ray, Broadband Microstrip Antennas, Artech House (2003).
- [3] Hattan F.Abu Tarboush, D.Budimir, R.Nilavalan and H.S.Al-Rawashidy, "Connected U-Slots Patch Antenna for WiMAX applications", International Journal of RF & Microwave CAE, 04/2010; 20(3):279-285, DOI:10.1002/mmce.20431.
- [4] Amit A. Deshmukh and K. P. Ray, "Multiband Rectangular Microstrip Antennas", IETE Journal of Research, Vol 57 | Issue 5 | sep-oct 2011.
- [5] Ramesh Patel, Jagannath Malik, Kumar Goodwill, M.V.Kartikayan, R.Nath, "A CPW-fed Broadband Swastik Shape PIFA for WiMAX(3.5GHz) Application", Conference on Advances in Communication and Control Systems, 2013(CAC2S 2013)
- [6] Jaswinder Kaur, Rajesh Khanna, "Co-axial Fed Rectangular Microstrip Patch Antenna for 5.2GHz WLAN Application", Universal Journal of Electrical and Electronics Engineering, 1(3):94-98, 2013, DOI:10.13189/ujee.2013.010306.
- [7] Dharmendra Rishishwar, Laxmi Shrivastava, "Dual-Band Microstrip Patch Antenna Using Frequency Selective Surface for Satellite Communication System in S Band", International Journal of Advanced Research in Computer Science & Technology, Vol. 1, Issue 1 Oct-Dec 2013.
- [8] Liang Xu, Zheng Yu Xin, and Jun He, "A Compact Triple-Band Fork-Shaped Antenna for WLAN/WiMAX Applications", Progress In Electromagnetics Research Letters, Vol. 40, 2013
- [9] Amber Haidery, Reshma Tawde, Tazeen Shaikh, "L-Slot Rectangular Microstrip Patch Antenna for WiMAX and WLAN Applications", International Journal of Emerging Technology and Advanced Engineering.
- [10] Pradutt K. Bharti, H.S.Singh, G.K.Pandey and M.K.Meshram, "Slot Loaded Microstrip Antenna for GPS, Wi-Fi and WiMAX Applications Survey", International Journal of Microwaves Applications, Volume 2, No.2, March-April 2013.
- [11] Amit Kumar, Sachin Kumar, Prof.P.R.Chadha, "Design of a Dual-Band Microstrip Patch Antenna for GPS, WiMAX and WLAN", IOSR Journal of Electronics and Communication Engineering (IOSR-JECE), Volume 6, Issue 2 (May-Jun. 2013), PP 56-59.
- [12] F.C.Ren, F.S.Zhang, J.H.Bao, B.Chen and Y.C.Jiao, "Compact Triple Frequency Slot Antenna for WLAN/WiMAX Operations", Progress In Electromagnetics Research Letters, Vol.26, 21,30,2011.