

# TRACE/FRAPTRAN Analysis of Kuosheng Nuclear Power Plant Dry-Storage System

J. R. Wang, Y. Chiang, W. Y. Li, H. T. Lin, H. C. Chen, C. Shih, S. W. Chen

**Abstract**—The dry-storage systems of nuclear power plants (NPPs) in Taiwan have become one of the major safety concerns. There are two steps considered in this study. The first step is the verification of the TRACE by using VSC-17 experimental data. The results of TRACE were similar to the VSC-17 data. It indicates that TRACE has the respectable accuracy in the simulation and analysis of the dry-storage systems. The next step is the application of TRACE in the dry-storage system of Kuosheng NPP (BWR/6). Kuosheng NPP is the second BWR NPP of Taiwan Power Company. In order to solve the storage of the spent fuels, Taiwan Power Company developed the new dry-storage system for Kuosheng NPP. In this step, the dry-storage system model of Kuosheng NPP was established by TRACE. Then, the steady state simulation of this model was performed and the results of TRACE were compared with the Kuosheng NPP data. Finally, this model was used to perform the safety analysis of Kuosheng NPP dry-storage system. Besides, FRAPTRAN was used to calculate the transient performance of fuel rods.

**Keywords**—BWR, TRACE, FRAPTRAN, Dry-Storage.

## I. INTRODUCTION

TAIWAN has four NPPs and for now all the spent fuels were set in the spent fuel pool inside each NPP. Someday the spent fuel pool will not be able to handle all the fuels, so Taiwan Power Company is now working on the plan that build up a dry-storage system of Kuosheng NPP. This dry-storage system is designed by the NAC Co. and it can store 87 bundles of spent nuclear fuels. In the SAR, many new analysis models and methodologies have been employed to evaluate the thermal-hydraulic behaviors and cooling ability in the dry-storage system. The previous analysis of Kuosheng NPP dry-storage system was done by CFD code [1].

In this study, SNAP 2.2.1 and TRACE v5.0p3 were used. TRACE is a modernized thermal-hydraulics code designed by NRC [2]. The main use of TRACE is focus on the NPPs system. But after this study, TRACE can also calculate a small system such as dry-storage cask. In the dry-storage system, one of the main methods of heat removal is nature circulation by air. In the study from 2013 fall CAMP meeting done by ENEA [3], their team showed that TRACE can calculate a nature circulation

J. R. Wang is with the Institute of Nuclear Energy Research, Atomic Energy Council, and the Institute of Nuclear Engineering and Science, National Tsing-Hua University, R.O.C., Taiwan (e-mail: jrwang@iner.gov.tw).

Y. Chiang and W.Y. Li are with the Institute of Nuclear Engineering and Science, National Tsing-Hua University, R.O.C., Taiwan (e-mail: s101013702@m101.nthu.edu.tw, fermmy@hotmail.com).

H.T. Lin is with the Institute of Nuclear Energy Research, Atomic Energy Council, R.O.C., Taiwan (e-mail: htlin@iner.gov.tw).

C. Shih and S.W. Chen are with the Institute of Nuclear Engineering and Science, National Tsing-Hua University, and Nuclear Information Center, R.O.C., Taiwan (e-mail: ckshih@ess.nthu.edu.tw).

inside a heated pipe. The applications of TRACE in NPPs before were always focus on the working fluid as water. In the dry-storage cases, main working fluids are He and air. So this study can also proof that TRACE can calculate the thermal-hydraulic properties well even the working fluid is He and air.

Then a dry-storage system model of Kuosheng NPP was built and this TRACE model was validated using data from a ventilated storage cask (VSC-17) collected by Idaho National Laboratory (INL). By comparing the calculations of this TRACE model and the experimental data, the feasibility of TRACE dry-storage model can be verified. After this, the Kuosheng NPP dry-storage model can be used on the safety analyses. The safety analyses always concern about the series accident such as big earthquake, so a fully-blockage and a fully-covered case were calculated in this study. The final step is the fuel rods integrity analysis of FRAPTRAN under the above conditions.

## II. THERMAL-HYDRAULIC CALCULATIONS OF TRACE

### A. Calculation of Helium and Air

The thermal-hydraulic calculation of air and He are very important in the dry-storage model. This part is going to show some detail of thermal-hydraulic properties of air and He in the TRACE theory manual. TRACE used the ideal-gas law for the air, hydrogen, and helium density correlations. Because the ideal-gas law accurately predicts gas behavior for low pressure and high temperature, and TRACE usually deals with this range of pressures and temperatures, consider the ideal-gas correlation to provide an adequate approximation for the gas densities. The density is calculated according to the following set of relationships:

$$\rho_a = \frac{P_a}{R_a T_g} \quad (1)$$

$$\left(\frac{\partial \rho_a}{\partial P_a}\right)_{T_g} = \frac{1}{R_a T_g} \quad (2)$$

$$\left(\frac{\partial \rho_a}{\partial T_g}\right)_{P_a} = -R_a \rho_a \left(\frac{\partial \rho_a}{\partial P_a}\right)_{T_g} \quad (3)$$

where  $\rho_a$  is microscopic density,  $P_a$  is the non-condensable partial pressure,  $T_g$  is the temperature of gas, and  $R_a$  is non-condensable constant.

Although the specific heat at constant pressure is temperature dependent. TRACE assumes the constant pressure specific heat of non-condensable gas to be constant, such that

$$C_{pa} = 1004.382 \frac{J}{Kg \cdot K} \text{ for air} \quad (4)$$

$$C_{pa} = 5193.086 \frac{J}{Kg \cdot K} \text{ for helium} \quad (5)$$

This assumption introduces errors that are deemed to be inconsequential to most transients of interest in PWRs.

Given that thermal conductivity is a strong function of temperature and a weak function of pressure. TRACE assumes the thermal conductivity of the non-condensable gas to be an exponential function of temperature only, such that

$$K_a = 2.091 \times 10^{-4} T_g^{0.846} \frac{W}{m \cdot K} \text{ for air} \quad (6)$$

$$K_a = 3.366 \times 10^{-3} T_g^{0.668} \frac{W}{m \cdot K} \text{ for helium} \quad (7)$$

### B. Calculation of Radiative-Heat-Transfer

In the dry-storage calculation, one of the most important thermal-hydraulic calculations is radiative-heat-transfer. The convection inside the steel canister was not very well due to the blockage of fuel tubes, so lots of the heat went out by radiation. In this study, the radiative-heat-transfer was included. The emissivity of fuel was set to 0.67 and for the steel canister was 0.36. The values were from the relevant document [1].

### C. Calculation of Concrete-Shielded

The thermal properties of each material used in this study were built inside the TRACE code except concrete. So the concrete was set by the user defined material. The detail is shown in Table I.

TABLE I  
 THERMAL PROPERTIES OF CONCRETE

Temperature (K)	296.72	352.27	407.83
Conductivity(W/m-K)	1.89	1.85	1.79
Density (Kg/m <sup>3</sup> )		2243	
Specific heat (J/Kg-K)		837.4	
Emissivity		0.9	
Absorptivity		0.6	

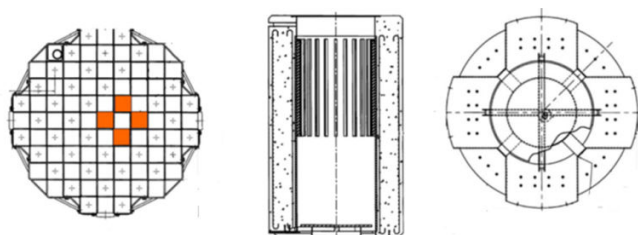

Fig. 1 Components of dry-storage system

## III. MODEL OF KUOSHENG NPP DRY-STORAGE SYSTEM

This dry-storage system was developed for BWR and it had 87 square-shaped fuel tubes for the spent fuels (shown in Fig. 1). The total power was about 17kW. The tubes were put in a sealed steel canister filled with helium. Fig. 1 also shows the concrete-shielded and the heat was remove by the air channel between steel canister and concrete-shielded (the middle one). The third picture in Fig. 1 is the bottom of this dry-storage

system, it was made by steel and in these cases the bottom was set to be adiabatic.

Fig. 2 shows the TRACE model of Kuosheng NPP dry-storage system developed based on the relevant document [1]. There were three parts in this model: fuel, steel canister and concrete-shielded. First is the part of fuel, there were totally 87 fuel tubes and each of them can storage a bundle of BWR spent fuel. The fuel tubes were about 4m long. The power distribution and axial power shape were just like the fuel removed from the spent fuel pool. In this model, all fuels were lumped together as one big fuel CHANNEL. The CHANNEL component had 25 axial cells and connected to ring 1 of VESSEL 1. Second part is the steel canister; it was a VESSEL with a heat structure about 4.5m high and the inner radius was 0.9m. VESSEL 1 has 31 axial cells and the 25 cells at the middle had same level as the 25 cells of fuel. The thickness of heat structure which used to model the steel wall was 0.0127m. This steel canister were fully sealed and the gas inside was He due to it has a higher heat transfer coefficient. The heat created by the fuel transferred to He and went to the steel canister. By connecting the flux of the inside canister wall and the second vessel, the heat generated by the fuel will transfer to the VESSEL 2, the air channel and the concrete-shielded. The valves were using to control the size of air channel entrance and exit. The thickness of the air channel via the steel was 0.092m. Also, there was a heat structure connected air channel and the outside temperature, this heat structure was using for modeling the concrete-shielded which thickness was about 0.67m. The air channel was connected to a big PIPE component. This PIPE was used to model the open area with atmospheric pressure and normal temperature 300K. With this connection, TRACE can calculate a nature circulation air flow rate by its self. There were two valves for the exit because TRACE had some problem with the air exchange when using only one valve. The initial condition was set to be some numbers that make sense in this situation. Then TRACE will calculate the normal storage case into a steady state. The initial pressure of He inside the steel canister was from the report [1]. A standard filled He density was about 0.744 kg/m<sup>3</sup> and which equal to the pressure about 0.514MPa (74.53psi) at initial temperature.

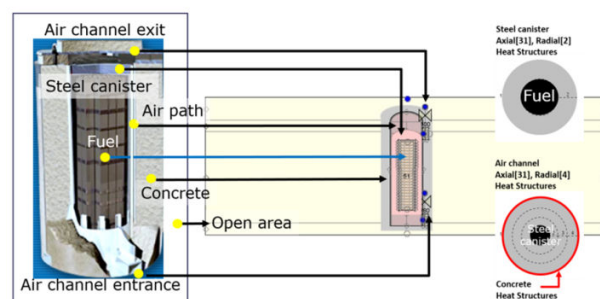

Fig. 2 TRACE model of Kuosheng NPP dry-storage system

## IV. MODEL OF VSC-17 DRY-STORAGE SYSTEM

VSC-17 was an experimental dry-storage system [4]. A TRACE model of VSC-17 was built to check the ability of

TRACE to calculate the dry-storage cases. The validation model was very similar to the Kuosheng NPP model. The only difference was the power and the geometric. Fig. 3 shows the power tubes. The power shape was set from the VSC-17 report data and it was separated to 6 parts in the power table of TRACE model. It is shown in Fig. 4. The fuel tubes in the VSC-17 model were also lumped together. The air flow value was from the CFD calculation due to the static pressure difference of the entrance and exit. It was about 0.65kg/s.

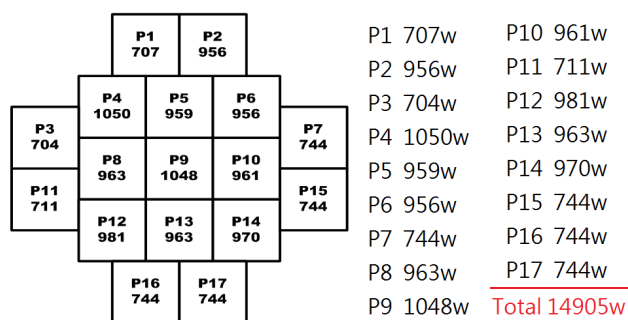

Fig. 3 Fuel tubes of VSC-17

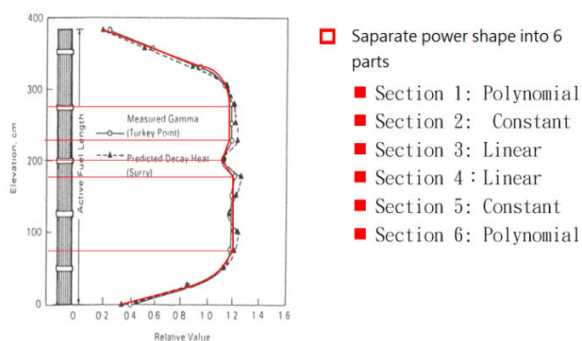

Fig. 4 Power distribution of VSC-17

## V. RESULTS

The dry-storage analysis by using TRACE model was described above. This analysis is divided into four parts: The VSC-17 model validation by comparing the TRACE results to the experimental data, and the three cases of Kuosheng NPP dry-storage system: steady state, fully-blockage and fully-covered.

### A. VSC-17 Analysis

The VSC-17 model was mention before and the following part is the validation of VSC-17 TRACE model. This analysis was used to check the model of TRACE in the dry-storage system. The initial temperature setting was a number that make sense in this situation. In this model, the outputs of TRACE were some steady state temperatures at each place. Fig. 5 is the fuel cladding temperature at different altitudes, the points are the temperature from VSC-17 experiments for each rod and the blue line is the output of TRACE. Since the fuel of TRACE model were lumped together, the TRACE outputs just had one temperature at each altitude. The number of fuel is shown in Fig. 4. Fuel P09 and P10 were closer to the center so they had a

higher temperature output. Fig. 5 shows that the results of TRACE fuel temperatures were located between the VSC-17 experimental data because the fuels were lumped together in TRACE and it was a kind of average rods here. Fig. 6 shows the temperature of steel canister surface. Both results indicate that TRACE has the respectable accuracy in the simulation and analysis of the dry-storage systems.

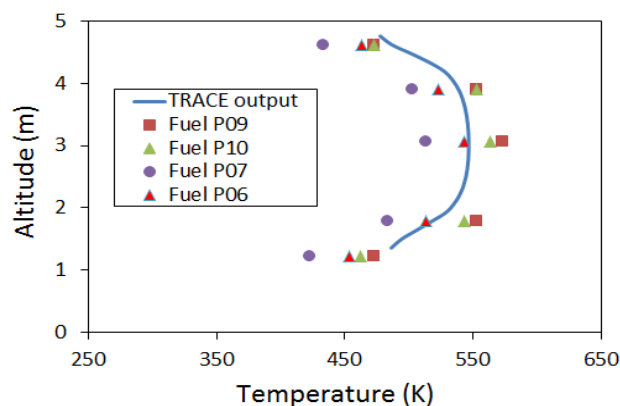

Fig. 5 Temperature distribution of cladding of VSC-17

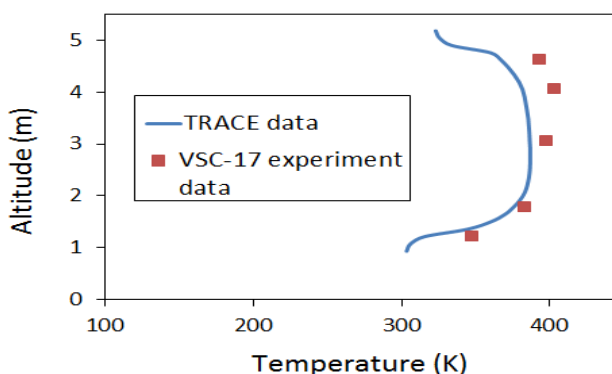

Fig. 6 Temperature distribution of steel canister surface

### B. Kuosheng NPP Dry-Storage System Analysis

There are three parts in the analysis of Kuosheng NPP dry-storage system analysis: steady state (normal storage), fully-blockage and full- covered. First, the steady state analysis can help us check that the cask can do a long term heat removal in the normal situation. Then it comes to the safety analysis. Fully-blockage case is that when the air entrance and exit were blocked, no air comes in and out, but the concrete-shielded still removed the heat by thermal conduction. In this kind of accident, the heat removal will be worse than normal situation but it still have a steady state that the temperature of cladding goes into constant. But the fully-covered case was not the same. All the cask will be cover by the mudflows or anything else generate by some natural disaster. The concrete cannot remove the heat by conduction, so the fuel temperature kept rising till the cladding failed. These analyses will focus on the max temperature and the pressure limit at each component. Table II shows the safety criteria of dry-storage system in different cases. The next 3 parts will compare the results to the safety criteria.

TABLE II  
 SAFETY CRITERIA OF TEMPERATURE IN DRY-STORAGE SYSTEM

Component	Normal storage	Accident
Fuel cladding	673K	843K
Steel canister	700K	700K
Concrete-shielded	366.6K	499.9K

### 1) Steady State Analysis (Normal Storage)

Table III shows the TRACE outputs, SAR [5] calculations of the max temperature in different components. The max temperature of fuel cladding was about 523.85K and the max temperature of steel canister was 452K in this case. The results calculated by TRACE were very close to the SAR calculations. The temperatures of fuel, steel and concrete were all lower than the safety criteria. The steady state temperatures were used to be the initial temperature of fully-blockage and fully-covered cases. Fig. 7 shows the radial temperature distribution of the steady state analysis. There are 4 parts shown in this picture: fuel, steel canister, air channel and concrete. The axial nodes chosen in this picture were the nodes in the middle. The design pressure limit of steel canister in the normal storage situation is 110psig (0.758MPa) and the TRACE calculation was 0.447MPa. It was far lower than the design limit.

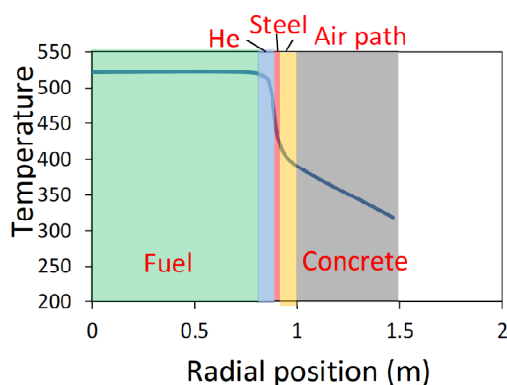

Fig. 7 Radial temperature distribution of normal storage

TABLE III  
 MAX TEMPERATURE OF STEADY STATE ANALYSIS

Component	TRACE (K)	SAR(K)
Fuel rods	523.85	
Fuel tubes	522.2	524
Steel canister	452	437
Concrete-shielded	326	336

### 2) Fully-Blockage Case Analysis

The fully-blockage case was the dry storage system model with the entrance and exit closed. The first 10 hours was the steady state than the air flow was closed by valve. The max hot node temperatures calculate by TRACE is shown in Figs. 8 and 9. Fig. 10 shows the radial temperature distribution of this analysis. The max temperature of fuel cladding was 609K and for steel canister was 517K. In the fully-blockage case, the fuel cladding temperature rose to 609K and went in a constant value. The temperature calculate by TRACE were a little lower than the SAR temperature. It was because TRACE was an average rod model in this study and also we did not have some material

details, conductive setting details of SAR model. Although the fully-blockage temperatures were higher than the steady state case, but it was still lower than the safety criteria. So in this case the dry storage system was safe. The design limit of steel canister pressure is 1.723MPa in un-normal cases. The max pressure calculated by in this fully-blockage case was 0.5226MPa. The pressure was still lower than design limit. Table IV shows the max temperature of fully-blockage analysis. After the TRACE analysis, FRAPTRAN input deck is established by the TRACE's results (ex: power, coolant conditions, heat transfer coefficients history data) and fuel rod geometry data. Fig. 11 shows the results of FRAPTRAN in this case. When the cladding temperature increased, the hoop strain and stress of cladding also went up.

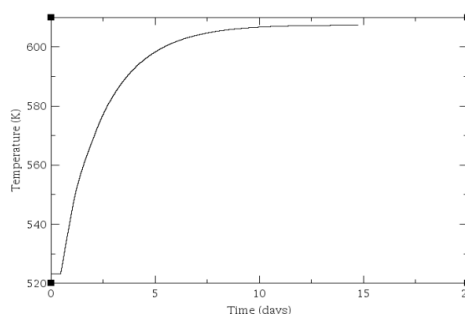

Fig. 8 Max hot node temperature of fuel cladding in fully-blockage case

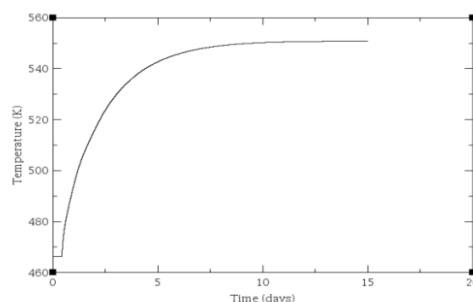

Fig. 9 Max hot node temperature of steel canister

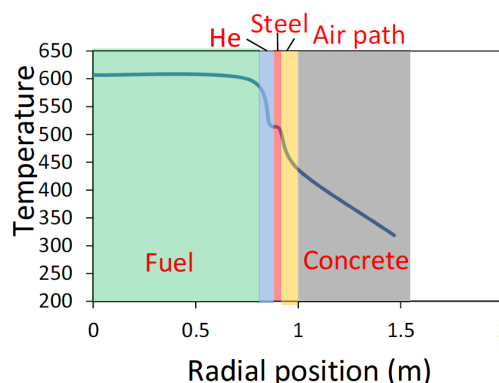

Fig. 10 Radial temperature of fully-blockage

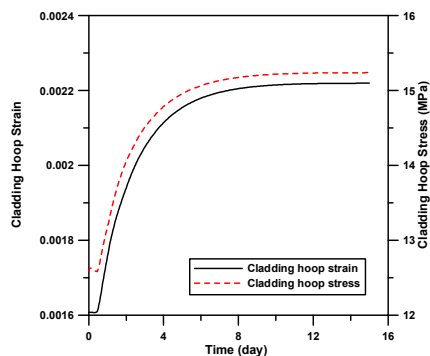

Fig. 11 Cladding hoop strain and stress of fuel rod

TABLE IV  
 MAX TEMPERATURE OF FULLY-BLOCKAGE ANALYSIS

Component	TRACE (K)	SAR(K)
Fuel rods	609	675
Fuel tubes	609	
Steel canister	517	544
Concrete-shielded	417	395

### 3) Fully-Covered Case Analysis

Fig. 12 shows the peak cladding temperature comparison of fully-covered and fully-blockage cases. The heat of the fully-covered case cannot go out and so the cladding temperature kept rising. The comparison of the fully-blockage and fully-covered cases was very important. It can show that how the temperature went up when the worst situation happened. The cladding temperature of fully-blockage was 609K, it was lower than the safety criteria (843K). In Fig. 12, the temperature of fully-covered case rose faster and it only took 4.5 days to reach the temperature of fully-blockage case (609K). Then the temperature kept rising to the safety criteria (843K) in 19.2 days. The pressure inside steel canister was 0.73MPa at 19.2<sup>th</sup> day. It was much lower than the design limit of steel canister (1.723MPa). Fig. 13 shows the results of FRAPTRAN in this case. When the cladding temperature increased, the hoop strain and stress of cladding also went up. However, the hoop strain increased and stress dropped sharply after about 23 days. Besides, the oxide thickness of cladding went up after 28 days in fully-covered case (see Fig. 14) and kept constant in fully-blockage case. According to the above results of FRAPTRAN, it indicated that the integrity of cladding was not kept after 23 days for fully-covered case. Fig. 15 is the animation model of this dry-storage system. This model was built by combining TRACE and SNAP. The important temperature of each part can easily be seen in this model and it can help others to understand the analysis of dry-storage system.

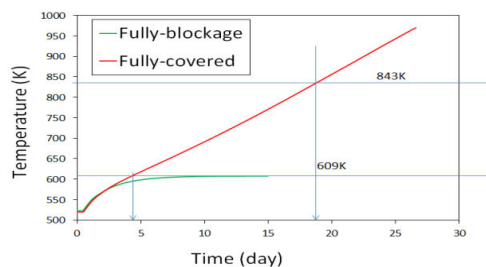

Fig. 12 Max hot node temperature of fuel in fully-covered and fully-blockage cases

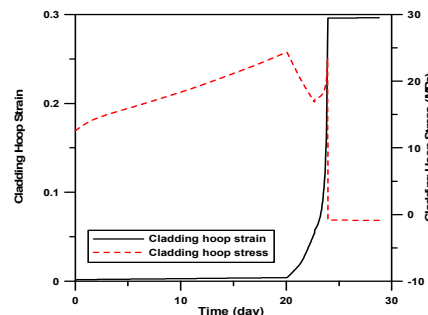

Fig. 13 Cladding hoop strain and stress of fuel rod in fully-covered case

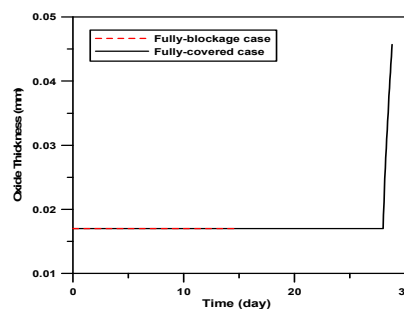
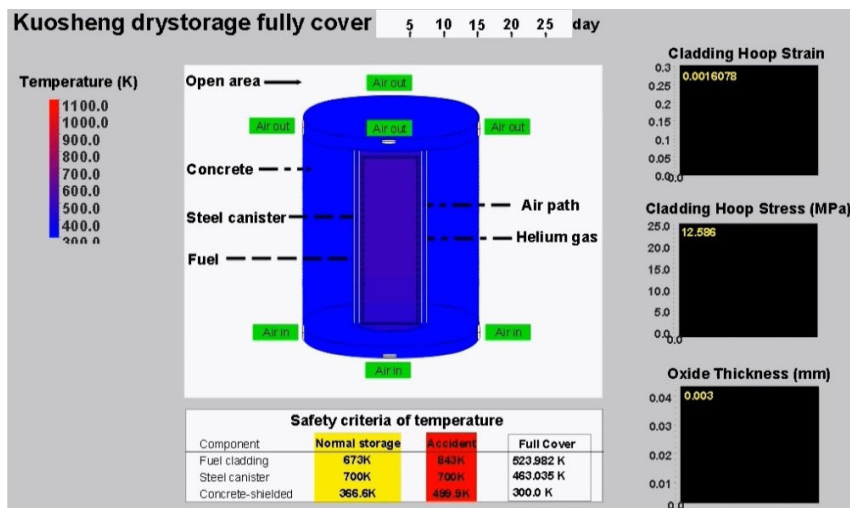
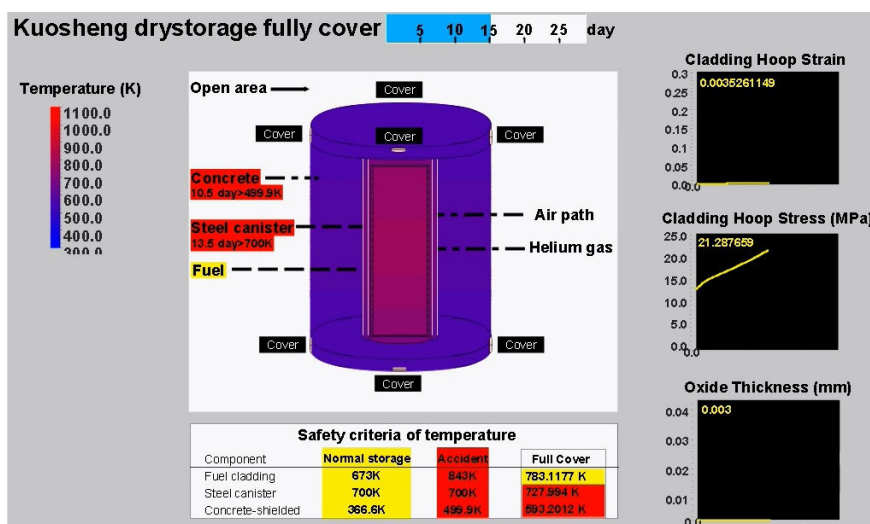

Fig. 14 Oxide thickness of fuel rod in fully-covered and fully-blockage case



(a) 0 day



(b) 15 day

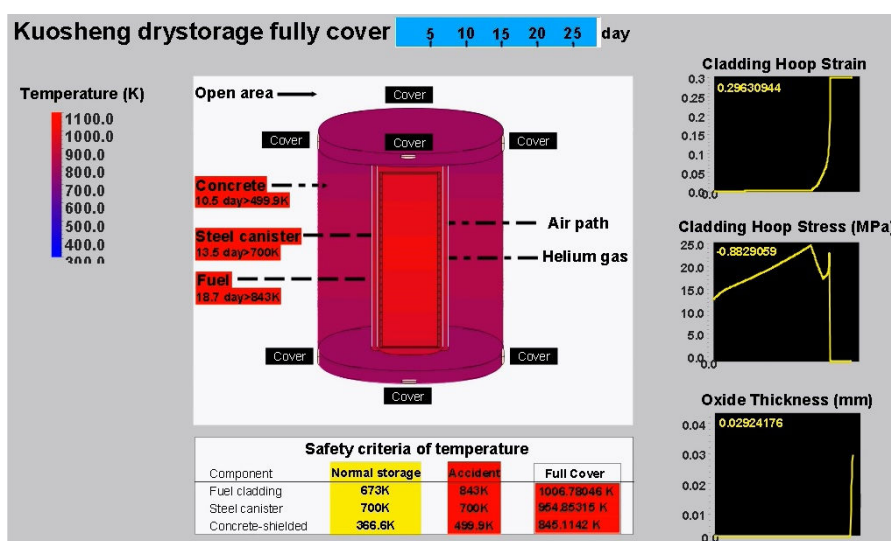

(c) 29 day

Fig. 15 Animation model of Kuosheng NPP dry-storage system(a) 0 day(b) 15 day(c) 29 day

## VI. CONCLUSION

By the calculation of TRACE/FRAPTRAN in the dry-storage system, this study gives several conclusions:

1. Although TRACE is a system code, it can also do the calculation such as dry-storage system.
2. TRACE can calculate the temperature well when the working fluid changes to air and He.
3. TRACE can calculate the nature circulation of air in the dry-storage system.
4. In the accident analysis of Kuosheng NPP dry-storage system, there are safety concerns only in the fully-covered case and the cladding temperature took 19.2 days to reach the safety criteria.
5. The pressures inside the steel canister were always lower than the design limit in the cases of this study.
6. According to the results of FRAPTRAN, it indicated that the integrity of cladding was not kept after 23 days for fully-covered case.

## REFERENCES

- [1] C. Shih, Y. S. Tseng, "The final report of parallel validation study for KSDSS," 2013.
- [2] NRC, "TRACE V5.0 User's Manual", Office of Nuclear Regulatory Research, 2010.
- [3] F. Mascari, A. M. Colletti, B. G. Woods, A. M. Costa, K. Welter, M. L. Richiusa, F. D. Rosa, F. D'Auria, G. Vella, "Analyses of Natural Circulation Phenomena Typical of the MASLWR by Using The TRACE V5 Code," 2013.
- [4] Pacific Northwest Laboratory, "Performance testing and Analyses of the VSC-17 Ventilated Concrete Cask," 1992.
- [5] Taipower Co., "FSAR of Kuosheng NPP Dry Storage System," 2013.