

Power Management Strategy for Solar-Wind-Diesel Stand-alone Hybrid Energy System

Md. Aminul Islam, Adel Merabet, Rachid Beguenane, Hussein Ibrahim

Abstract—This paper presents a simulation and mathematical model of stand-alone solar-wind-diesel based hybrid energy system (HES). A power management system is designed for multiple energy resources in a stand-alone hybrid energy system. Both Solar photovoltaic and wind energy conversion system consists of maximum power point tracking (MPPT), voltage regulation, and basic power electronic interfaces. An additional diesel generator is included to support and improve the reliability of stand-alone system when renewable energy sources are not available. A power management strategy is introduced to distribute the generated power among resistive load banks. The frequency regulation is developed with conventional phase locked loop (PLL) system. The power management algorithm was applied in Matlab®/Simulink® to simulate the results.

Keywords—Solar photovoltaic, wind energy, diesel engine, hybrid energy system, power management, frequency and voltage regulation.

I. INTRODUCTION

HYBRID Energy Systems (HES) can provide environment friendly and cost effective energy solutions with higher reliability and power quality. Instead of conventional energy stand-alone HES based on renewable energy resources can provide decent supply of electrical energy in remote locations. Besides compared to conventional power systems, HES can substantially reduce fuel consumption and emission. Wind energy is a complimentary power generation system. In recent years, wind energy has been gaining interest due to an increased emphasis on environmental sustainable resources as well as progress in wind technologies [1]. Since wind power is unreliable due to random nature of wind, the combination of solar photovoltaic (PV) and wind energy conversion system is preferred to improve the reliability of hybrid power generation systems in remote locations. Solar PV power generation is common renewable energy source which is frequently being used in distributed generation and microgrid [2]. A diesel generator is provided with the hybrid energy system in case of unavailability of power from renewable energy sources.

A power management strategy is developed to improve the reliability and power quality of the stand-alone system. Wind energy systems are recommended due to clean and renewable electricity generation [2], [3]. However, given the arbitrary

M. A. Islam and A. Merabet are with the Division of Engineering, Saint Mary's University, Halifax, NS, Canada (e-mail: md.aminul@smu.ca, adel.merabet@smu.ca).

R. Beguenane is with the Department of Electrical and Computer Engineering, Royal Military College of Canada, Kingston, ON, Canada (e-mail: rachid.beguenane@rmc.ca).

H. Ibrahim is with Wind Energy Techno-Centre, Gaspé, QC, Canada.

nature of wind energy, hybrid operation should be implemented with other source of energy. The idea of solar photovoltaic power generation emerges to improve the reliability and accomplish the demand in remote locations. In this study priority is given to wind energy system and recommended to keep always online. Solar PV and diesel power generation are designed to operate depending on load demand and availability of power.

In this paper, a simulation and mathematical model of stand-alone wind energy conversion system combined with a solar photovoltaic and diesel engine based power generation system is introduced. Both solar and wind energy conversion system is developed with maximum power point tracking (MPPT) control, power electronic interface and voltage regulators. A diesel power generator is connected with the hybrid system due to random nature of renewable energy sources. Frequency regulation is controlled by a simple discrete three-phase locked loop (PLL) control strategy along with resistive dumping load.

Section II describes the mathematical and simulation model of solar photovoltaic cell, PV module, PV array along with maximum power point tracking (MPPT), DC/DC boost converter and voltage regulation. Section III describes the mathematical and simulation model of wind energy conversion system, MPPT for wind turbine and voltage regulation through power electronic interface. The simulation model for diesel energy conversion system is described in Section IV. The power management strategy between energy sources is introduced in Section V. Frequency regulation of stand-alone system is discussed in Section VI. Section VII shows the results from simulation model and conclusion of the work is stated in Section VIII.

II. MODELING SOLAR PV ENERGY CONVERSION SYSTEM

A. Modeling Solar Cell, Module and Array

A simulation model is developed to generate the behavior of solar photovoltaic cell. The equivalent circuit of a solar PV cell can be expressed like following [4], [5];

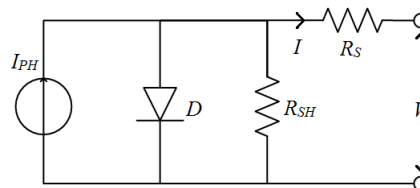

Fig. 1 Equivalent circuit of solar photovoltaic cell

A mathematical equation of load current can be obtained

from the equivalent circuit in Fig. 1. The load current equation is given below [6]:

$$I = I_{PH} - I_S \left[\exp \frac{q(V+I R_S)}{NKT} - 1 \right] - \frac{(V+I R_S)}{R_{SH}} \quad (1)$$

where, I is the load current, I_{PH} is the photocurrent, I_S is the diode saturation current, q is the electron charge, V is the cell terminal voltage, N is the diode ideality factor, K is the Boltzmann constant, T is the cell temperature, R_S and R_{SH} is the series and shunt resistance respectively. The behavior of a solar PV cell directly depends on these parameters.

A 250W PV module is applied to create a photovoltaic array equivalent to 6kW. In order to develop a PV module following data has been taken into consideration from the datasheet of CS6P-250M PV module manufactured by Canadian Solar [7].

TABLE I
 KEY SPECIFICATION OF CS6P-250M PV MODULE UNDER STC

Electrical Characteristics	CS6P-250M
Nominal Maximum Power	250W
Optimum Operating Voltage	30.4V
Optimum Operating Current	8.22A
Open Circuit Voltage, V_{OC}	37.5V
Short Circuit Current, I_{SC}	8.74A
Temperature Coefficient of I_{SC} , K_i	0.005A/°C

The table shows key specification of CS6P-250M PV module under standard test condition (STC). This model generates the effect of varying solar irradiation and cell temperature. Output of a PV module varies as a function of solar irradiance which can be obtained from the following equation [4]-[6], [8]:

$$I_{PH} = [I_{SC} + K_i(T - T_{ref})] \frac{B}{1000} \quad (2)$$

Here, I_{SC} is the short circuit current, K_i is the temperature coefficient of short circuit current, T is the cell temperature, T_{ref} is the reference temperature and B is the solar irradiation in W/m^2 . In this work the solar irradiation varies from 600 to 800 W/m^2 .

Effect of varying temperature on PV module can be achieved from a mathematical expression. The diode saturation current varies as a cubic function of cell temperature and can be expressed as following [4]-[6], [8]:

$$I_S(T) = I_{RS} \left(\frac{T}{T_{ref}} \right)^3 e^{-\frac{qV_t}{NK \left(\frac{1}{T} - \frac{1}{T_{ref}} \right)}} \quad (3)$$

In this equation, I_{RS} is the diode reverse saturation current and V_t is the thermal voltage. The cell reverse saturation current can be obtained from the equation given below [6], [8]:

$$I_{RS} = \frac{I_{SC}}{[e^{qV_{OC}/NKT}]} \quad (4)$$

Based on (1)-(4), a simulation model is constructed with Matlab®/Simulink® interface to develop 6kW solar PV energy conversion system.

B. Maximum Power Point Tracking (MPPT) for Solar PV

Maximum power point tracking (MPPT) is a technique that ensures the maximum power extraction from non-linear energy sources like solar PV systems. The algorithm allows the controller to operate PV module at optimum voltage and current so the extraction of maximum power is ensured. Among several MPPT algorithms incremental conductance method is recommended for solar PV operation [9], [10].

Incremental conductance method estimates the relation between the operating point voltage, U and the maximum power point voltage, U_{max} [9]. Method of increasing conductivity follows three conditions; $U < U_{max}$, $U > U_{max}$ and $U = U_{max}$. To realize the maximum power point (MPP) a reference voltage U_{ref} is applied. When light intensity and outside temperature changes, the incremental conductance method control the output voltage to track the maximum power point voltage smoothly and also reduces oscillation phenomena near the maximum power point. However, this control algorithm is very complicated, and the setting of adjusting voltage ΔU influences the maximum power point tracking accuracy greatly. The method can be expressed like following formula:

$$\frac{dI}{dU} = -\frac{I}{U}; \left(\frac{dP}{dU} = 0 \right) \text{ at MPP thus } U = U_{max} \quad (5a)$$

$$\frac{dI}{dU} > -\frac{I}{U}; \left(\frac{dP}{dU} > 0 \right) \text{ left of MPP thus } U < U_{max} \quad (5b)$$

$$\frac{dI}{dU} < -\frac{I}{U}; \left(\frac{dP}{dU} < 0 \right) \text{ right of MPP, thus } U > U_{max} \quad (5c)$$

A power electronic interface is required to operate MPPT and extract maximum power from solar PV.

C. Power Electronic Interface for Solar PV

A DC/DC boost converter regulates the voltage to meet the requirement of system bus voltage. MPPT controller generates the duty cycle to operate the boost converter and to step-up the voltage from 120V to 600V. A standard voltage source converter (VSC) is applied to generate switching pulses for DC/AC three-phase inverter and to regulate the voltage.

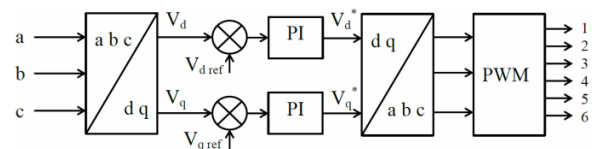

Fig. 2 Voltage regulator for solar PV

III. MODELING WIND ENERGY CONVERSION SYSTEM

A. Modeling Wind Turbine and Energy Conversion

The model is developed based on steady state wind turbine power characteristic [11]. Two assumptions should be considered to express mechanical power delivered by wind

turbine:

- i. Wind turbine inertia and friction factor is combined with generator model and
- ii. The drive train stiffness factor is infinite

The mechanical power, P_m delivered by wind turbine can be expressed as following:

$$P_m = C_p(\lambda, \beta) \frac{\rho A v_w^3}{2} \quad (6)$$

Here, C_p is power coefficient of the turbine, ρ is air density (kg/m^3), A is turbine swept area (m^2), v_w is wind speed (m/s), β is blade pitch angle (degree) and λ is tip speed ratio which can be obtained from;

$$\lambda = \frac{\omega_r R}{v_w} \quad (7)$$

where, ω_r is the rotor shaft speed and R is radius of the rotor blade. The wind energy conversion system is developed using Matlab[®]/Simulink[®]/SimPower[®] toolbox where the turbine is coupled with a permanent magnet synchronous generator (PMSG). The mathematical expression of mechanical power from wind turbine in (6) provides mechanical input for PMSG.

B. Maximum Power Point Tracking (MPPT) for Wind Energy

The maximum power point tracking (MPPT) algorithm is developed based on generated power and is designed to simulate and determine the reference rotor speed, ω_{ref} [12]. A flowchart is given below to show the algorithm of MPPT to extract the maximum power out of wind turbines.

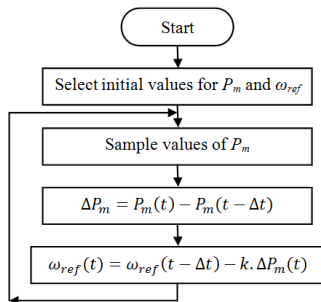

Fig. 3 Flowchart of MPPT algorithm for wind turbine

The parameter k is defined by following expression in [13] where α is a positive gain;

$$k = \alpha \cdot \omega(t)^{-1} \quad (8)$$

C. Power Electronic Interface for Wind Energy

A set of power electronic interface is applied to regulate the DC-link voltage and in turn regulate the load voltage. Vector control scheme is employed for the load side converter. The complete control is divided into two sections:

- i. DC-link voltage regulator and
- ii. Current regulator

IV. MODELING DIESEL ENERGY CONVERSION SYSTEM

In this simulation model the diesel energy conversion system consists of a diesel engine with governor system and coupled with a synchronous generator. The major components of diesel engine model include a controller, actuator and delay. The considered diesel engine model [14] uses:

- i. The controller for checking the steady-state error in speed and
- ii. The actuator with gain K , time constant T_i and integrator altogether for controlling the fuel rack position.

The model of diesel engine is developed with second order controller and actuator [15]. The existence of non-linear, time varying, dead-time between the fuel injection and production of mechanical torque, T_{mech} makes the diesel engine a non-linear system. A standard PI controller is applied to control the speed and prevent steady-state error. The mechanical torque, T_{mech} is modeled by conversion of fuel flow to torque after a time delay e^{-sTD} . The mechanical torque produced in a diesel engine is expressed as following;

$$T_{mech}(s) = e^{-sTD} \phi(s) \quad (9)$$

V. POWER MANAGEMENT SYSTEM FOR HES

Compared to other renewable energy resources the availability of wind energy is very high. In this model priority is given to wind energy since it can generate power both in day and night. However, solar PV is also considered to keep in operation depending on load demand. Initially diesel engine provides support until the power generated either from solar PV or wind energy or total amount of generated power reaches minimum 5kW. As soon as the total generated power reaches 5kW the supervision system turns off the diesel engine.

Two banks of additional resistive load can be added depending on total generated power. If total power generation reaches 10kW the supervision system closes the breaker for first additional load. Breaker for second additional load is closed if total power generation reaches 12.5kW. So, total available load for stand-alone hybrid energy system is 15kW. The algorithm of supervision for power management can be expressed with following flow chart:

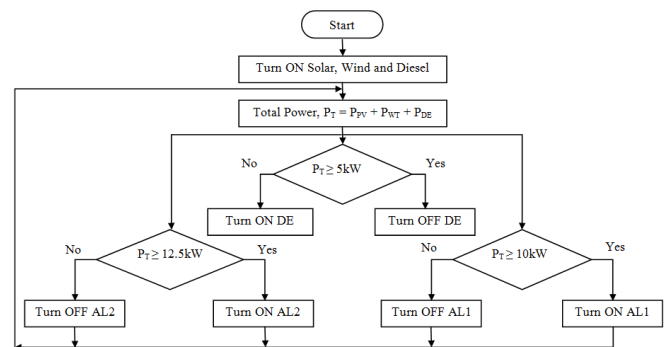

Fig. 4 Flow chart of power management algorithm for solar-wind-diesel hybrid energy system

Here, P_T is total power, P_{PV} , P_{WT} and P_{DE} is power generated by solar PV, wind turbine (WT) and diesel engine (DE) respectively. AL1 and AL2 are two additional resistive load banks along with the main load.

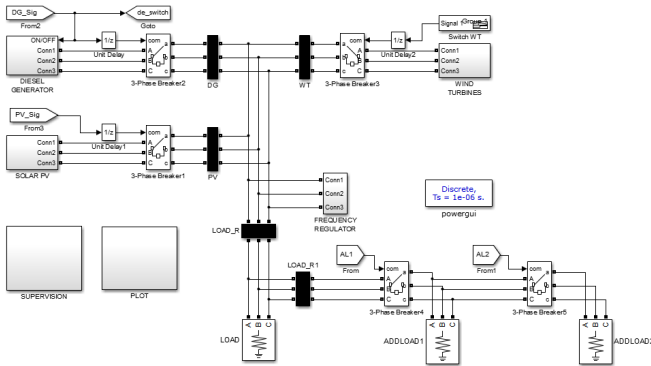

Fig. 5 Simulation model of stand-alone solar-wind-diesel hybrid energy system in Matlab®/Simulink®/SimPower® platform

VI. FREQUENCY REGULATION

The frequency regulation of this stand-alone hybrid energy system is developed with a set of resistive dump loads. Total 8 sets of resistive dump load are used to regulate the frequency in case of over generation of electrical power and each set of dump load consumes 0.5kW power. Maximum power consumed by dump loads in this system is 4kW.

First bank of 0.5kW dump load is turned on in case of extra power in the system. If the system requires rest banks are added in operation to regulate the frequency. According to the North-American standard frequency is always kept constant at 60Hz. The controller for frequency regulation is developed with a standard three phase locked loop (PLL) control strategy. It allows the system to operate at a constant frequency and synchronize the operation with multiple sources.

VII. SIMULATION AND RESULTS

A simulation is performed to study the behavior of the power management for solar-wind-diesel stand-alone hybrid energy model. The model is constructed with Matlab®/Simulink® and SimPower® platform. Following are the results plotted from simulation:

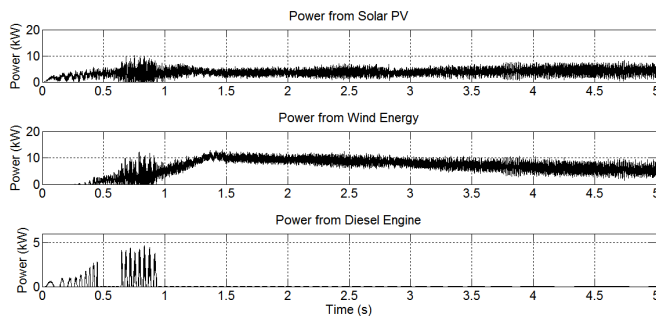

Fig. 6 Power generated by solar PV, wind energy and diesel engine

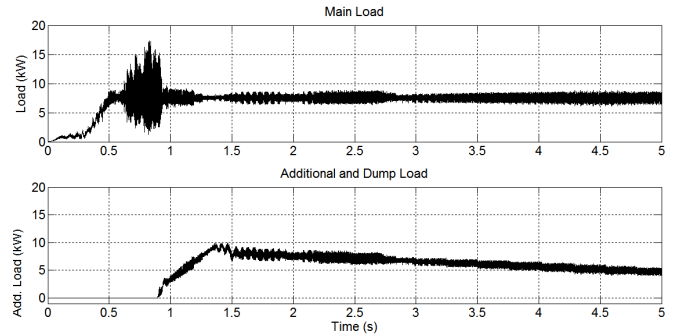

Fig. 7 Resistive main load, additional load and dump load power in Kw

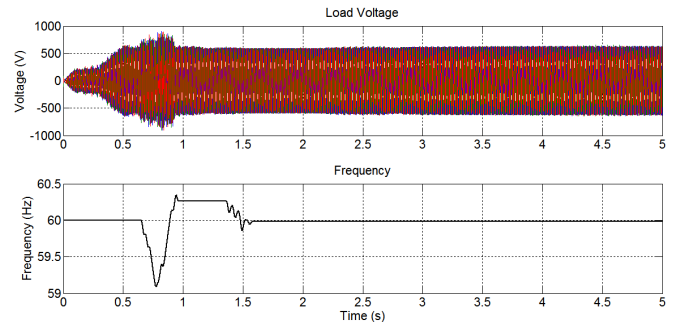

Fig. 8 Load voltage (V) and system frequency (Hz)

Fig. 6 shows the power generated by solar PV, wind energy and diesel generator. The average power generated by solar PV is approximately 6 kW. Wind energy generates up to 10kW depending on load demand. Diesel engine is switched off when total generated power reaches 5kW.

The load power in kW consumed by resistive main load, additional load and dump load is plotted in Fig. 7. The breaker for first additional load bank is closed when both solar PV and wind energy conversion system is in operation and empowering 10kW main load. Another breaker for second additional load is closed when total power generation reaches 12.5kW.

In order to regulate the frequency, all dump loads are being added along with additional loads between 0.8s to 1.5s. The frequency regulator turns them off gradually when the frequency is stable at 60Hz after 1.5s.

Fig. 8 shows the regulation of voltage at load side and the status of system frequency. Some fluctuation in load voltage is noticed between the period of 0.6s to 0.8s when both solar and wind energy are added in operation. The system frequency is being affected during the same period due to same operation.

VIII. CONCLUSION

This study presents an elaborative model of a hybrid energy system (HES). The simulation model is developed to study the behavior of stand-alone solar-wind-diesel HES. In this paper the mathematical model of solar and wind energy conversion system is described. Both solar and wind energy conversion system consists maximum power point tracking and voltage regulation technique. A simple power management strategy is developed to analyze the reliability of hybrid energy system.

A set of resistive dump load is applied to regulate the system frequency. Continuation of this work will include control systems to minimize the transient effects during different mode of operation and frequency regulation with energy storage.

APPENDIX

Wind turbine parameter: $\rho = 1.14 \text{kg/m}^3$

Permanent Magnet Synchronous Generator: Nominal power = 10kW

Diesel Generator: Nominal Power = 50kW

Main Load = 10kW, Additional Load = 2.5kW each

Dump load = 4kW

REFERENCES

- [1] J.M. Yang, K.W.E. Cheng, J. Wu, P. Dong and B. Wang, "The Study of the Energy Management System based on Fuzzy Control for Distributed Hybrid Wind-Solar Power System," *Proc. of First International Conference on Power Electronics Systems and Applications*, pp. 113-117, Nov. 2004.
- [2] Y. Zhu, F. Zhuo and H. Shi, "Power Management Strategy Research for a Photovoltaic-Hybrid Energy Storage System," *IEEE ECCE Asia Downunder*, pp. 842-848, June 2013.
- [3] C. Wang, J. Li, C.M. Colson, "Power Management of a stand-alone Hybrid Wind-microturbine Distributed Generation System," *IEEE Power Electronic and Machines in Wind Applications*, pp. 1-7, June 2009.
- [4] W. Chen, H. Shen, B. Shu, H. Qin and T. Deng, "Evaluation of performance of MPPT devices in PV systems with storage batteries," *Renewable Energy*, vol.32, no.9, pp. 1611-1622, July 2007.
- [5] T. Salmi, M. Bouzguenda, A. Gastli and A. Masmoudi, "Matlab/Simulink based modeling of solar photovoltaic cell," *International Journal of Renewable Energy Research*, vol.2, no.2, pp. 213-218, Feb. 2012.
- [6] M.A. Islam, A. Merabet, R. Beguenane and H. Ibrahim, "Modeling Solar Photovoltaic Cell and Simulated Performance Analysis of a 250W PV Module," *IEEE Electrical Power & Energy Conference*, pp. 1-6, Aug. 2013.
- [7] Canadian Solar, "CS6P 240/245/250/255/260M," *CS6P-250M Datasheet*, 2013. [Online]. Available: <http://www.canadian-solar.com>
- [8] S. Kebaili and A. Betka, "Design and Simulation of Stand Alone Photovoltaic Systems," *WSEAS Transactions on Power Systems*, vol.6, no.4, pp. 89-99, Oct. 2011.
- [9] L. Qin and X. Lu., "Matlab/Simulink-based Research on Maximum Power Point Tracking of Photovoltaic Generation," *Physics Procedia*, vol. 24, pp. 10-18, 2012.
- [10] D.P. Hohm and M.E. Ropp, "Comparative study of maximum power point tracking algorithms," *Progress in Photovoltaics: Research and Applications*, vol. 11, no. 1, pp. 47-62, 2003.
- [11] S. Heier, "Grid Integration of Wind Energy Conversion Systems," *New York: Wiley*, 1998.
- [12] M. Zhou, G. Bao and Y. Gong, "Maximum Power Point Tracking Strategy for Direct Driven PMSG," *2011 IEEE Asia-Pacific Power and Energy Engineering Conference (APPEEC)*, pp. 1-4, 2011.
- [13] A. Merabet, V. Rajasekaran, A. McMullin, Hussein Ibrahim, Rachid Beguenane and J.S. Thongam, "Nonlinear Model Predictive Controller with State Observer for Speed Sensorless Induction Generator -Wind Turbine Systems," *Proceedings of the Institution of Mechanical Engineers, Part I: Journal of Systems and Control Engineering*, vol.227, no.2, pp. 198-213. 2013.
- [14] L.N. Hannett, F.P de Mlello, G.H. Tylinski and W.H. Becker, "Validation of Nuclear Plant Auxiliary Power Supply by Test," *IEEE Transactions on Power Apparatus and Systems*, vol.9, pp. 3068-3074, 1982.
- [15] K.E. Yeager and J.R. Willis, "Modeling of Emergency Diesel Generators in an 800 Megawatt Nuclear Power Plant," *IEEE Transactions on Energy Conversion*, vol.8, no.3, pp. 433-441, 1993.