

Software-Defined Radio Based Channel Measurement System of Wideband HF Communication System in Low-Latitude Region

P. H. Mukti, I. Kurniawati, F. Oktaviansyah, A. D. Adhitya, N. Rachmadani,
R. Corputty, G. Hendrantoro, T. Fukusako

Abstract—HF Communication system is one of the attractive fields among many researchers since it can be reached long-distance areas with low-cost. This long-distance communication can be achieved by exploiting the ionosphere as a transmission medium for the HF radio wave. However, due to the dynamic nature of ionosphere, the channel characteristic of HF communication has to be investigated in order to give better performances. Many techniques to characterize HF channel are available in the literature. However, none of those techniques describe the HF channel characteristic in low-latitude regions, especially equatorial areas. Since the ionosphere around equatorial region has an ESF phenomenon, it becomes an important investigation to characterize the wideband HF Channel in low-latitude region. On the other sides, the appearance of software-defined radio attracts the interest of many researchers. Accordingly, in this paper a SDR-based channel measurement system is proposed to be used for characterizing the HF channel in low-latitude region.

Keywords—Channel Characteristic, HF Communication System, LabVIEW, Software-Defined Radio, Universal Software Radio Peripheral.

I. INTRODUCTION

SINCE past decades, HF Communication systems have attracted a lot of interest from the researchers to develop and evaluate the performance of such systems. This attraction came due to the advantages of HF communication system. Beside as an alternative of the more expensive satellite communication system, HF communication systems have the ability to access remote or rural areas which are difficult to access by wire communication system. This long-distance communication can be achieved by employing ionosphere as transmission medium. By using the ionosphere, the HF transmitted signals reach a receiver through the refraction by the charged particles in the ionosphere [1].

The performance of HF Communication systems which work in the frequency range of 3-30 MHz, is heavily influenced by the dynamic nature of the ionosphere layers. Therefore, the HF

channel characteristic has to be analyzed to understand its behavior and obtain better system performance.

There exist many approaches in the literature to characterize the behavior of Wideband HF channel [2]-[4]. In [2], the 3000 km link of HF communication channel characteristic is measured in the mid-latitude area of America. The characteristics of HF channel are represented in terms of time and frequency spread as well as autocorrelation and distribution function [3], [4]. The HF channel characteristic in high-latitude is reported in [5].

In low-latitude areas, especially in equatorial region, there is the so-called equatorial anomaly caused by the variation of electron density with latitude dissimilar to that in mid- and high-latitude [1]. In such conditions, a phenomenon called Equatorial Spread F (ESF) might appear which potentially causes larger delay spread compared to mid- and high-latitude [6]. This condition gives more challenges in development of HF communication systems in low-latitude areas. Unfortunately, the studies on HF channel communication characteristic in low-latitude areas, especially in Indonesia, are not much reported.

In this paper, the first step of HF Communication development in low-latitude area, namely HF Channel characteristic will be discussed. HF channel characteristic is investigated by using a kind of Wideband HF channel measurement system. Our novelty not only the investigation of HF channel characteristic in low-latitude region, but also the implementation of HF channel measurement system based on software-defined radio (SDR).

In order to obtain better estimates of channel characteristics, represented in HF channel response, of wideband HF communication system in low-latitude region, a proper measurement system should be setup. There are many techniques on establishing the HF measurement system [7]-[9]. Those of measurement systems require complex technique to be implemented. Hence, a software-defined radio (SDR) based measurement system is proposed to be applied for wideband HF channel characterization.

The rest of the contents of this paper are organized as follows. Section II describes system designs, including measurement parameters which should be considered to setup the measurement system and prototyping the system based on SDR. System validation and calibration are elaborated in Section III. Finally, Section IV summarizes the study.

II. MEASUREMENT SYSTEMS

A software-defined radio (SDR) system is a radio

Prasetyono Hari Mukti, Indah Kurniawati, Fredy Octaviansyah, Aryo Darma Adhitya, Nisa Rachmandani and Gamantyo Hendrantoro are with Department of Electrical Engineering, Institut Teknologi Sepuluh Nopember, Kampus ITS Sukolilo, Surabaya 60111, Indonesia (e-mail: prasetyono@elect-eng.its.ac.id, kurniawati12@mhs.ee.its.ac.id, gamantyo@ee.its.ac.id)

Robert Corputty is with Department of Electrical Engineering, Universitas Musamus, Jl. Kamizaun Mopah Lama, Merauke, Indonesia (e-mail: bertyuol@yahoo.com)

Takeshi Fukusako is with the Department of Computer Science and Electrical Engineering, Kumamoto University, Kumamoto 860-8555, Japan (e-mail: fukusako@ieec.org)

communication system where components that have been typically implemented in hardware, e.g. mixers, filters, amplifiers, modulators/demodulators, detectors, etc., are instead implemented by means of software on a personal computer or embedded computing devices [10].

SDR based measurement system is implemented using software and hardware. The software part of our measurement system is realized using LabVIEW to generate and receive the signal at transmitter and receiver, respectively, whilst the hardware part is implemented using URSP N210. The LabVIEW usually utilizes USRP which is a digital acquisition (DAQ) system facilitated with ADC and DAC converters, and support circuitry such as Ethernet interface.

Furthermore, since the channel characteristic will be examined in term of complex impulse responses, power delay profile and delay spreads, the measurement system should, at least, consists of PN-sequence generator at transmitter; IQ-demodulator and power meter at receiver. The block diagram of such system is shown in Fig. 1.

Prior to the realization, the specification of measurement system should be determined, such as the PN-sequence length, frequency carrier, symbol rate, sampling rate, etc, as shown in Table I. From the specification design, the schematic diagram is drawn based on software-defined radio from LabVIEW. Fig. 2 illustrates the implementation of SDR-based measurement system to characterize the HF channel.

The channel is probed using Pseudo Random Binary Sequence (PRBS) or PN sequence signals in the form of maximal-length sequence with $M = 12$ (or equivalently, with period of 4095 bits) with bit rate of 500 kb/s. LabVIEW

controls a Universal Software Radio Peripheral (USRP) N210 to generate the sequences and modulate with BPSK modulation. The received signal is IQ-demodulated and then sampled at 1 MS/s by another USRP to yield 8190 samples in a sequence period. The example of received IQ signals is illustrated in Fig. 3. The difference between Inphase (I) and Quadrature (Q) signals is occurred due to the phase shifting of the signal. At the receiver, I and Q samples are obtained for analyzing the complex impulse response. Besides that, the received signal power is also measured to obtain power delay profile of the HF channel.

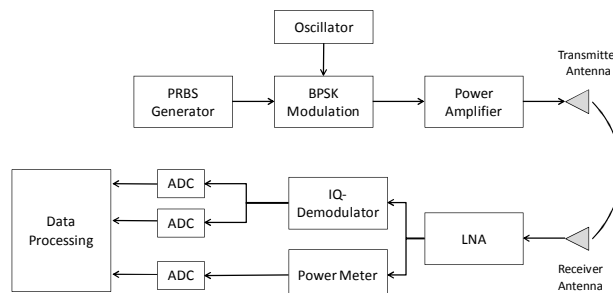

Fig. 1 Basic Block Diagram of HF Channel Measurement Systems

Parameter	Value
Frequencies	7 MHz
PN Sequence	Stage (m) = 12
Symbol rate	500 Kbps
Sampling rate	1 MHz
Modulation	BPSK
Demodulation	IQ-Modulator

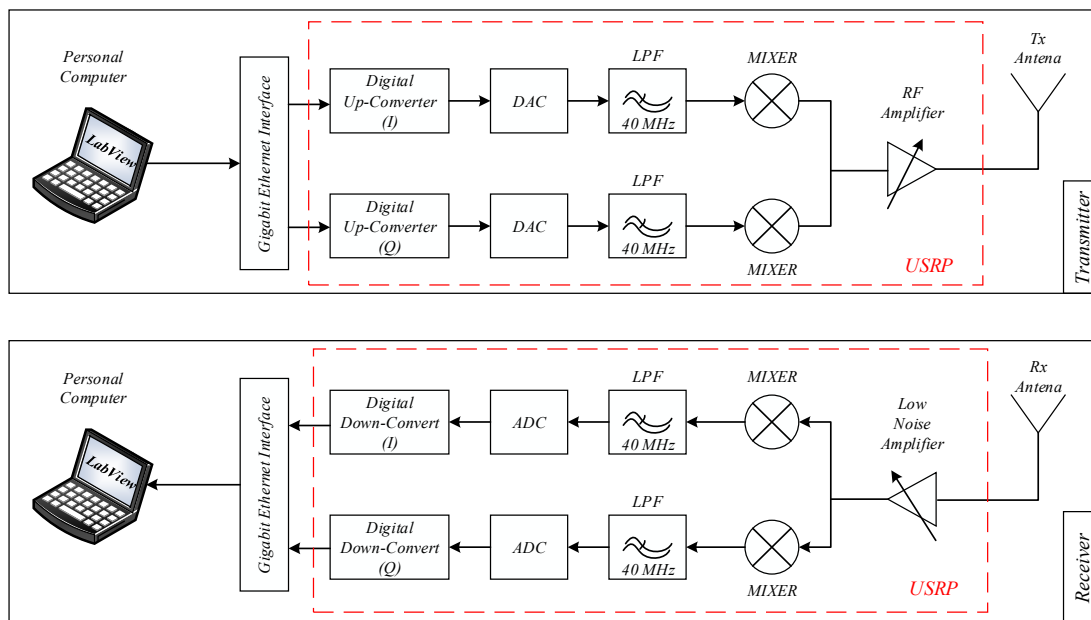

Fig. 2 Block Diagram of SDR-Based Measurement System

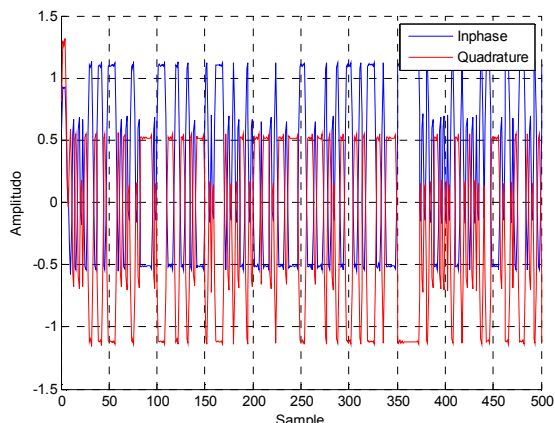

Fig. 3 Received IQ Signal

III. SYSTEM VALIDATION

Prior to implementation in a real measurement, the measurement system should be validated to ensure that such system performs as the system expected. The validations are conducted for several purposes as follow,

1. The genuineness of transmitted signal. To ensure that the system transmits PN-sequence correctly, the transmitted signal is auto-correlated. The result of auto-correlated transmitted signal is shown in
2. Fig. 4. Compared to the PN-sequence order in Table I, it can be proven that the transmitted signal has the same order to the generated signal.

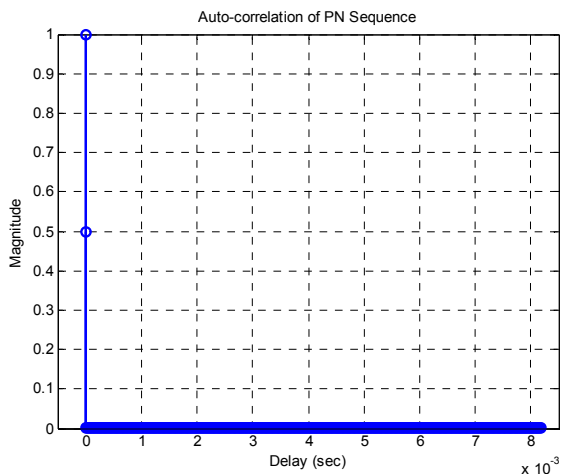

Fig. 4 Autocorrelation Results of transmitted signal

3. The ability to obtain channel impulse response. It can be done by cross-correlating the received signal with the transmitted signal. To test this ability, PN sequence is transmitted to the receiver through an ideal channel which does not experience any multipath. The received signal which has 4 periods of signal is then correlated to the PN Sequence. This cross-correlated signal is illustrated in Fig. 5. From the figure it can be concluded that the measurement system works properly since the system yields the impulses only at beginning of receiving period.

4. Response Frequency of the amplifier. Since the system uses amplifiers to enhance the power signal, it is necessary to know the characteristic of amplifier gains as function of frequency. Fig. 6 and 7 show the frequency response characteristic of amplifier 1 and 2, respectively. From those figures, we can know that the optimal power gain of the Amplifier-1 is 27.5 dB at 10 MHz, approximately, whilst for the Amplifier is around 40 dB in frequency range of 5-10 MHz.

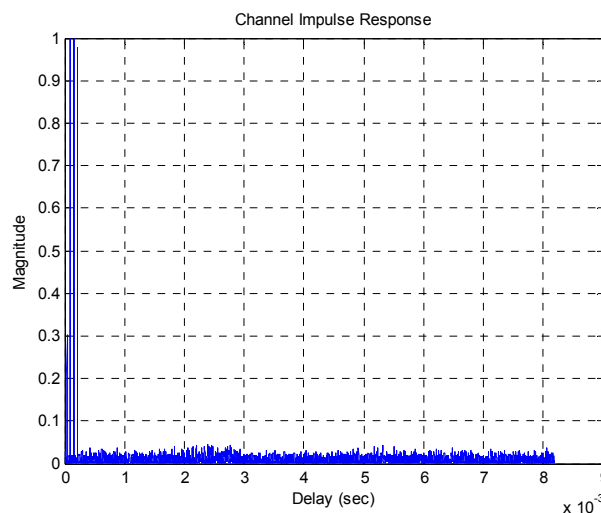

Fig. 5 Channel Impulse Response

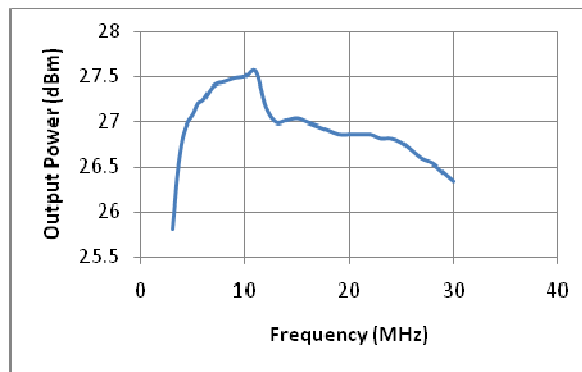

Fig. 6 Frequency Response of Amplifier 1

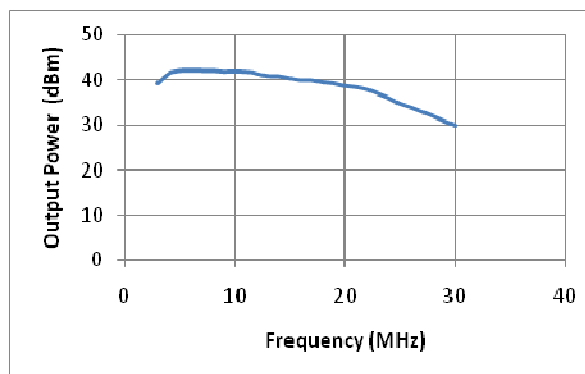

Fig. 7 Frequency Response of Amplifier

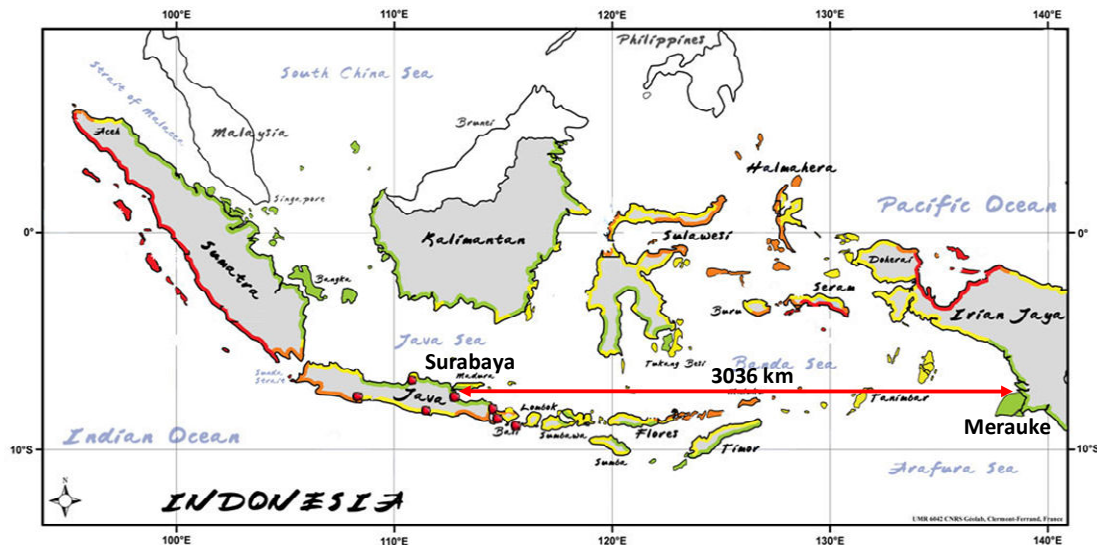

Fig. 8 Locations of HF Channel Measurement Systems

IV. FURTHER WORKS

The HF channel measurement is to be conducted between Surabaya (07°15'S 112°45'E) and Merauke (08°30'S 140°27'E) on a 3036 kilometer link. In Surabaya, the transmitter is installed at Building B of Department of Electrical Engineering in the campus of ITS, while the receiver is installed on the rooftop of Electrical Engineering Building in the campus of Universitas Musamus, Merauke. Both locations of measurement system are depicted in Fig. 8.

V. CONCLUSIONS

The usage of software-defined radio based for measurement system development of HF Communication system in low-latitude region is addressed. The prototype of measurement system is implemented using LabVIEW and USRP for the software and hardware part, respectively. The investigation of system accuracy shows a good performance. The ability of the system to characterize the HF channel is also demonstrated. This implementation will lead to the flexibility of the system to meet the required specifications.

ACKNOWLEDGMENT

This research is partially sponsored by the Indonesian Ministry of Education and Culture through the 2013 Hibah Penelitian Strategis Nasional and by JICA through PREDICT Phase 2 Joint Research B3-3 grant.

REFERENCES

- [1] L. F. McNamara, *The Ionosphere: Communication, Surveillance, and Direction Finder*, Krieger Publishing Company, 1991.
- [2] B. D. Perry and R. Rifkin, "Measured Wideband HF Mid Latitude Channel Characteristics", in *Proc 1989 IEEE Military Communication*, pp 822 -829.
- [3] R. Rifkin and B.D Perry, "Long Term Wide-Bandwidth Channel Characteristics and Bandwidth Dependent Fading For A-Mid Latitude HF Path", in *Proc 1991 Fifth International Conference on HF Radio System and Techniques*, pp 189 – 193.

- [4] M. A. Wallace, "HF Radio in South West Asia", *IEEE Communication Magazine* January (1992), pp 58-61.
- [5] P.S. Cannon, M.J. Angling, N.C Davies, T. Wilink, V. Jodalen, B. Jacobson, B. Lundborg, M. Broms, "Damson HF channel characterisation-a review," in *Proceeding of 21st Century Military Communications (MILCOM 2000)*, Vol.1, pp.59-64, 2000
- [6] J. Lastovicka, A. Bourdillon, "Ionospheric Effects on Terrestrial Communication: Working Group 3 overview" *Annals of Geophysics*, Supplement to Vol. 47, no 2/3, pp.1269-1276, 2004
- [7] P.A Bello, "Some Techniques for the Instantaneous Real-Time Measurement of Multipath and Doppler Spread", *IEEE Transaction on Communication Technology*, vol. 13, no. 3, pp285-292, Sept. 1965.
- [8] L. Ehrman, L. Bates, J. Eschle, J. Kates, J., "Real-Time Software Simulation of the HF Radio Channel," *IEEE Transactions on Communications*, vol.30, no.8, pp.1809,1817, Aug 1982
- [9] Yang Guo; Ke Wang, "A Real-Time Software Simulator of Wideband HF Propagation Channel," *International Conference on Communication Software and Networks*, 2009. ICCSN '09, pp.304,308, 27-28 Feb. 2009
- [10] M. Dillinger, K. Madani and N. Alonistioti, *Software Defined Radio: Architectures, Systems and Functions*, Wiley & Sons, 2003