

Nonlinear Response of Infinite Beams on a Tensionless Extensible Geosynthetic – Reinforced Earth Beds under Moving Load

Karuppsamy K., Eswara Prasad C.R.

Abstract—In this paper analysis of an infinite beam resting on tensionless extensible geosynthetic reinforced granular bed overlying soft soil strata under moving load with constant velocity is presented. The beam is subjected to a concentrated load moving with constant velocity. The upper reinforced granular bed is modeled by a rough elastic membrane embedded in Pasternak shear layer overlying a series of compressible nonlinear Winkler springs representing the under-lying very poor soil. The tensionless extensible geosynthetic layer has been assumed to deform such that at interface the geosynthetic and the soil have some deformation. Nonlinear behavior of granular fill and the very poor soil has been considered in the analysis by means of hyperbolic constitutive relationships. Detailed parametric study has been conducted to study the influence of various parameters on the response of soil foundation system under consideration by means of deflection and bending moment in the beam and tension mobilized in the geosynthetic layer. This study clearly observed that the comparisons of tension and tensionless foundation and magnitude of applied load, relative compressibility of granular fill and ultimate resistance of poor soil has significant influence on the response of soil foundation system.

Keywords—Infinite Beams, Tensionless Extensible Geosynthetic, Granular layer, Moving Load and Nonlinear behavior of poor soil

I. INTRODUCTION

CIVIL engineers, especially geotechnical engineers face several challenges in the construction of earth structures like retaining walls and embankments which cater to the development of transport infrastructure. Soil reinforcement plays a major part in strengthening of earth structures and utilization of soft foundation soils. In recent years, geosynthetics are commonly used in reinforced earth beds over-lying poor soil. Geosynthetics are widely utilized for the improvement of the bearing capacity and reduction in settlement response of foundation on poor soils. Analysis of reinforced soil structures subjected to external forces can be done based on many mechanics like classical continuum mechanics or lumped mass model or finite element modeling. As lumped parameter modeling is relatively easier to formulate, many researchers have contributed in this area.

K. Karuppsamy, M.Tech, Assistant Engineering Manager (Geotechnical Services), L&T Construction (Building & Factories), Chennai – 600 089, India (phone: +91-44-2252 8386; fax: +91-44-2252-6064; e-mail: kksamy@lntec.com).

C. R. Eswara Prasad, M.Tech, Chief Engineering Manager (Geotechnical Services), L&T Construction (Building & Factories), Chennai – 600 089, India (phone: +91-44-2252 8350; fax: +91-44-2252-6064; e-mail: CREP@lntec.com).

Most of literatures are related to static loading conditions as well as linear response of poor soil strata. Some of these studies are due to Madhav and Poorooshab [9], [10], Ghosh and Madhav [4], [5], Shukla and Chandra [11]–[13], Yin [14]–[16], Zhan and Yin [17]. Hence there is a need to develop new analytical methods for nonlinear response of tensionless extensible geosynthetic - reinforced foundation subjected to moving load under the very poor soil.

In the present work, modeling and analysis of an infinite beam resting on tensionless extensible geosynthetic reinforced-granular bed on soft soils has been studied with the lifting up partially and losing contact with the soils. The reinforcement has been considered to be tensionless extensible and compatibility conditions as suggested by Yin [14] have been incorporated, reducing the number of parameters involved in this analysis. The foundation assumed to react only in compression. The nonlinear responses of tensionless extensible geosynthetic - reinforced foundation and foundation reaction in tension have been compared and further various parametric studies have been conducted considering values of input parameters with respect to the Indian railway conditions and the influence of various parameters of soil – foundation system. Finite difference method is used for the solution of governing differential equations of the model and all the results have been presented in non-dimensional forms. The properties of different layers of base, sub-base and foundation may be incorporated in the model by taking the equivalent stiffness of the nonlinear spring.

II. STATEMENT OF THE PROBLEM AND PROPOSED MODEL

Fig. 1 shows the definition sketch of the problem considered in the infinite beam resting on tensionless extensible geosynthetic reinforced granular fill – poor soil system. The infinite beam has been founded on a granular fill layer overlying poor foundation soil of thickness (H) and subjected to concentrated moving load (P). A geosynthetic layer has been placed inside the granular fill layer which divides the granular fill layer into two, having thicknesses as H_t and H_b as shown in Fig. 1. The shear modulus of upper and the lower layer of granular fill are G_t and G_b respectively, while μ_t and μ_b are the interfacial friction coefficients at the top and bottom of the reinforcement layer respectively. The response of the beam under the action is to be found out.

Fig. 2 depicts the proposed model for the soil – foundation model under consideration. The poor soil subgrade has been idealized as nonlinear Winkler springs and the granular fill

layer as Pasternak Shear layer. The granular fill layer has been assumed to be incompressible and the beam has been assumed to have a perfect contact with granular fill layer. A rough elastic membrane has been used to model the geosynthetic layer.

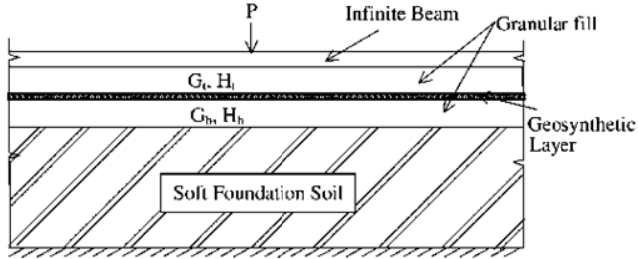

Fig. 1 Definition sketch of geosynthetic-reinforced granular fill soft soil system

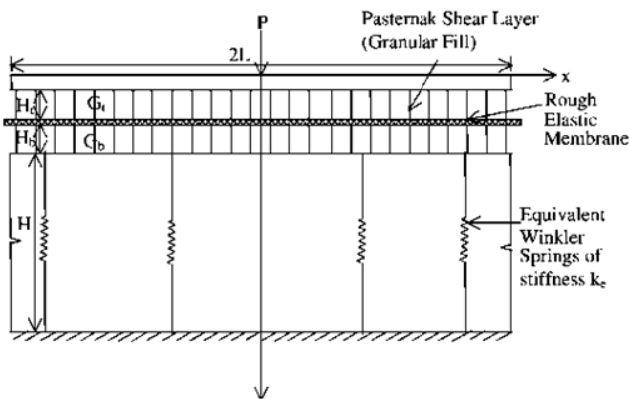

Fig. 2 Definition sketch of proposed model for soil foundation system

III. ANALYSIS

Fig. 3 presents the free body diagram of the upper shear layer, membrane and the lower shear layer elements.

The vertical force equilibrium equation of the upper shear layer element can be written as;

$$q = q_t - G_t H_t \frac{\partial^2 w(x,t)}{\partial x^2} \quad (1)$$

where, q is the reaction of granular fill on the beam, q_t is the vertical force interaction between the membrane and the upper shear layer, $w(x, t)$ is the vertical surface deflection, G_t is the shear modulus upper shear layer, H_t is the thickness of the upper shear layer, x is the horizontal space coordinate measured along the length of the beam and t is any particular instant of time.

The vertical force equilibrium equation of the lower shear layer element at time, $t > 0$, can be written as;

$$q_b = q_s - G_b H_b \frac{\partial^2 w(x,t)}{\partial x^2} \quad (2)$$

where, q_s is the vertical force interaction between the lower shear layer $G_b H_b$ and the poor foundation soil, and are the shear modulus and thickness of the lower shear layer respectively.

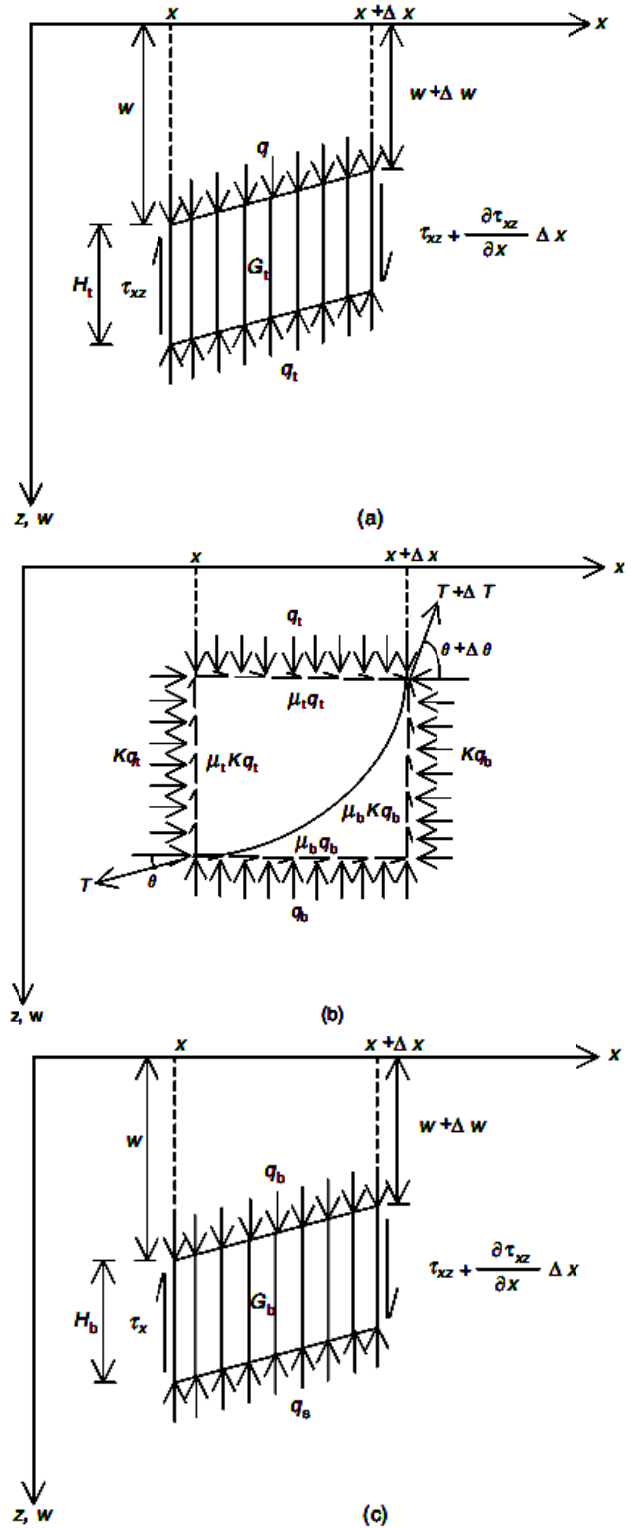

Fig. 3 Definition (a) forces on upper shear layer; (b) forces on stretched rough, elastic membrane element (c) forces on lower shear layer element

The horizontal force equilibrium equation of the rough elastic membrane element at time $t > 0$, can be written as;

$$\cos \theta \frac{\partial T(x,t)}{\partial x} - T \sin \theta \frac{\partial \theta}{\partial x} = -(\mu_t q_t + \mu_b q_b) - K(q_t - q_b) \tan \theta \quad (3)$$

where, q_b is the vertical force interaction between the membrane and the shear layer, μ_b and μ_t are the interface coefficients at the bottom and top faces of membrane respectively, K is the coefficient of lateral stress, θ is the slope of the membrane, $T(x, t)$ is the mobilized tensile in the geosynthetic layer.

The vertical force equilibrium equation for the rough elastic membrane element at time $t > 0$ can be written as:

$$\sin \theta \frac{\partial T(x,t)}{\partial x} + T \cos \theta \frac{\partial \theta}{\partial x} = -K(\mu_t q_t + \mu_b q_b) \tan \theta + (q_t - q_b) \quad (4)$$

From (3) and (4), one can write,

$$q_t = q_b + \frac{T \sec \theta}{(1 + K \tan^2 \theta)} \frac{\partial \theta}{\partial x} - \frac{(1 - K)(\mu_t q_t + \mu_b q_b) \tan \theta}{(1 + K \tan^2 \theta)} \quad (5)$$

Substituting for $\frac{\partial \theta}{\partial x}$ in terms of vertical displacement, $w(x, t)$ in to (5), and one can write;

$$q_t = \bar{X}_1 q_b - \bar{X}_2 T \sec \theta \frac{\partial^2 w}{\partial x^2} \quad (6)$$

where,

$$\bar{X}_1 = \frac{1 + K \tan^2 \theta - (1 - K)\mu_b \tan \theta}{1 + K \tan^2 \theta + (1 - K)\mu_t \tan \theta} \quad (7a)$$

$$\bar{X}_2 = \frac{1}{1 + K \tan^2 \theta + (1 - K)\mu_t \tan \theta} \quad (7b)$$

The shear modulus of granular layers can be expressed by considering hyperbolic shear stress – shear strain response [4], [5] as;

$$G_t = \frac{G_{t0}}{\left[1 + \frac{G_{t0} |dw/dx|}{\tau_{ut}} \right]^2} \quad (8a)$$

$$G_b = \frac{G_{b0}}{\left[1 + \frac{G_{b0} |dw/dx|}{\tau_{ub}} \right]^2} \quad (8b)$$

where, G_{t0} and G_{b0} are initial shear modulus of upper and lower granular layer respectively. τ_{ut} and τ_{ub} are the ultimate shear resistance of upper and lower granular layer respectively.

Considering the hyperbolic nonlinear Stress- displacement relationship [7], q_s can be expressed as,

$$q_s = \frac{k_{s0} w}{1 + \frac{k_{s0} w}{q_u}} \quad (9)$$

where, k_{s0} is the initial modulus of subgrade reaction of poor soil and q_u is the ultimate bearing capacity of the poor soil.

Combining (1), (2), (6), (8) and (9),

$$q = \frac{k_{s0} w}{1 + \frac{k_{s0} w}{q_u}} \bar{X}_1 - (G_t H_t + \bar{X}_2 T \cos \theta + G_b H_b \bar{X}_1) \frac{\partial^2 w}{\partial x^2} \quad (10)$$

where, q is the reaction of the granular fill on beam.

Combining (3) and (4), we get

$$\frac{\partial T}{\partial x} = (q_t - q_b)(1 - K) \sin \theta - (\mu_t q_t + \mu_b q_b)(1 + K \tan^2 \theta) \cos \theta \quad (11)$$

Combining (1), (2), (9) and (11) following equation can be obtained:

$$\frac{\partial T}{\partial x} = -\bar{X}_3 \left(q + G_t H_t \frac{\partial^2 w(x,t)}{\partial x^2} \right) - \bar{X}_4 \left(\frac{k_{s0} w}{1 + \frac{k_{s0} w}{q_u}} - G_b H_b \frac{\partial^2 w(x,t)}{\partial x^2} \right) \quad (12)$$

where,

$$\bar{X}_3 = (\mu_t \cos \theta (1 + K \tan^2 \theta) - (1 - K) \sin \theta) \quad (13a)$$

$$\bar{X}_4 = (\mu_t \cos \theta (1 + K \tan^2 \theta) + (1 - K) \sin \theta) \quad (13b)$$

The differential equation of a moving load on the beam may be obtained by considering the bending of an elemental segment. The differential equation of the beam with uniform cross section can be written as follows:

$$EI \frac{d^4 w}{dx^4} + \rho \frac{d^2 w}{dt^2} + c \frac{dw}{dt} + q = P(x, t) \quad (14)$$

where, $w(x, t)$ is the deflection of the beam, EI is the flexural rigidity of the beam, ρ is the mass per unit length of the beam, c is the coefficient of viscous damping per unit length of the beam, $P(x, t)$ is the applied load intensity, In the absence of damping equation (14) can be written as,

$$EI \frac{d^4 w}{dx^4} + \rho \frac{d^2 w}{dt^2} + q = P(x, t) \quad (15)$$

Equations (10), (12), and (15) govern of the response of the proposal model in the absence of damping. For particular values of the parameters, these equations govern the response of existing models for beams on elastic foundation subjected to moving load [1], [6].

IV. SOLUTION OF THE GOVERNING EQUATIONS

The response of system has been represented as a function of distance (x) from the center of the beam at time (t). For simplicity, substituting $\xi = x - vt$ where, ' ξ ' is the distance from the point of action of loading at time 't'. The governing differential equations have only one variable ξ .

Equations (10), (12) and (15) can be written as;

$$q = \frac{k_{s0}w}{1 + \frac{k_{s0}w}{q_u}} \bar{X}_1 - (G_i H_i + \bar{X}_2 T \cos \theta + G_b H_b \bar{X}_1) \frac{\partial^2 w}{\partial \xi^2} \quad (16)$$

$$\frac{\partial T}{\partial \xi} = -\bar{X}_3 \left(q + G_i H_i \frac{\partial^2 w}{\partial \xi^2} \right) - \bar{X}_4 \left(\frac{k_{s0}w}{1 + \frac{k_{s0}w}{q_u}} - G_b H_b \frac{\partial^2 w}{\partial \xi^2} \right) \quad (17)$$

$$EI \frac{d^4 w}{d\xi^4} + \rho v^2 \frac{d^2 w}{d\xi^2} + q = P(\xi) \quad (18)$$

To observe the settlement response of the proposed model, (16), (17) and (18) have been written in non-dimensional form as given below,

$$q^* = \frac{W}{1 + \frac{W}{q_u}} \bar{X}_1 - (G_i^* + \bar{X}_2 T^* \cos \theta + G_b^* \bar{X}_1) \frac{\partial^2 W}{\partial \xi^{*2}} \quad (19)$$

$$\frac{dT^*}{d\xi^{*2}} = -\bar{X}_3 \left(q^* + G_i^* \frac{d^2 W}{d\xi^{*2}} \right) - \bar{X}_4 \left(\frac{W}{1 + \frac{W}{q_u}} - G_b^* \frac{d^2 W}{d\xi^{*2}} \right) \quad (20)$$

$$\frac{d^4 W}{d\xi^{*4}} + \frac{\rho^*}{I^*} \frac{d^2 W}{d\xi^{*2}} + \frac{q^*}{I^*} = \frac{P^*(\xi^*)}{I^*} \quad (21)$$

where; $\xi^* = \xi / L$; $G_{i0}^* = G_{i0} H_i / k_{s0} L^2$; $G_{b0}^* = G_{b0} H_b / k_{s0} L^2$; $q^* = q / k_{s0} L$; $\tau_{ub}^* = \tau_{ub} / k_{s0} L$; $I^* = EI / k_{s0} L^4$; $q_u^* = q_u / k_{s0} L$; $\tau_{ut}^* = \tau_{ut} / k_{s0} L$; $\rho^* = \rho v^2 / k_{s0} L^2$; $T^* = T / k_{s0} L^2$; $W = w / L$; $P^* = P / k_{s0} L^2 d\xi^*$ and P is the applied load, and L is half the length of the beam considered.

Finite difference formulation has been employed to solve the differential equations. In these equations, the derivatives are expressed by central difference method as follows;

$$\frac{d^4 W}{d\xi^{*4}} = \left(\frac{W_{i-2} - 4W_{i-1} + 6W_i - 4W_{i+1} + W_{i+2}}{\Delta \xi^{*4}} \right) \quad (22a)$$

$$\frac{d^2 W}{d\xi^{*2}} = \left(\frac{W_{i-1} - 2W_i + W_{i+1}}{(\Delta \xi^*)^2} \right) \quad (22b)$$

$$\frac{dW}{d\xi^*} = \left(\frac{W_{i+1} - W_{i-1}}{(2^* \Delta \xi^*)} \right) \quad (22c)$$

In (20) in the term $dT^* / d\xi^*$ is written in backward difference from for $-1 \leq \xi^* \geq 0$, whereas for $0 \leq \xi^* \leq 1$ forward difference is used for the same.

Writing (19), (20) and (21) in finite difference from within the specified space domain for an interior node i, one obtains;

$$q^* = \frac{W}{1 + \frac{W}{q_u}} \bar{X}_1 - (G_i^* + \bar{X}_2 T^* \cos \theta + G_b^* \bar{X}_1) \times \left(\frac{W_{i-1} - 2W_i + W_{i+1}}{(\Delta \xi^*)^2} \right) \quad (23)$$

$$T_{i+1}^* = T_i^* - \bar{X}_3 \Delta \xi^* \left(q^* + G_i^* \left(\frac{W_{i-1} - 2W_i + W_{i+1}}{(\Delta \xi^*)^2} \right) \right) - \bar{X}_4 \Delta \xi^* \left(\frac{W}{1 + \frac{W}{q_u}} - G_b^* \left(\frac{W_{i-1} - 2W_i + W_{i+1}}{(\Delta \xi^*)^2} \right) \right) \quad (24)$$

$$W_i = \frac{1}{\left(6 - 2 \frac{\rho^* \times \Delta \xi^{*2}}{I^*} \right)} \times \left[\frac{P^* \Delta \xi^{*3}}{I^*} - \frac{q^* \times \Delta \xi^{*4}}{I^*} - W_{i-2} - W_{i+2} - \left(-4 + \frac{\rho^* \times \Delta \xi^{*2}}{I^*} \right) \times W_{i-1} - \left(-4 + \frac{\rho^* \times \Delta \xi^{*2}}{I^*} \right) \times W_{i+1} \right] \quad (25)$$

V. BOUNDARY CONDITIONS

Boundary conditions have been considered at the edge of the beam. At both ends of the beam, the deflection of the beam, the slope of the deflected shape of the beam and the mobilized tension are zero. These boundary conditions can be written in non-dimensional form as follows;

$$\text{At } \xi^* = -1 \text{ and } 1, W = 0, \frac{dW}{d\xi^*} = 0 \text{ and } T^* = 0.$$

VI. RESULTS AND DISCUSSIONS

Based on the formulation presented in previous section, a computer program was developed using finite difference scheme. Complete region of the problem ($-L \leq x \leq L$) was considered. The total length of the beam (2L) was divided into various numbers of elements and it was observed that the difference in results corresponding to 800 and 1000 numbers of elements was less than 0.5%; hence 800 elements were used and the solution was obtained with a tolerance limit of 10^{-5} . Half the length of the beam is taken to be large enough for the beam to be assumed to act as an infinite beam. The following values of parameters have been adopted for the parameter study as shown in Table I.

TABLE I
 RANGE OF VALUES OF VARIOUS PARAMETERS CONSIDERED FOR PARAMETRIC STUDY

Parameters	Symbol	Range of values	Unit
Applied Load	P	100 – 250	KN
Mass per unit length of beam	ρ	52	Kg/m
Flexural Rigidity of beam	EI	4.47×10^6 [8]	N- m ²
Modulus of sub-grade reaction for poor foundation soil	k_{so}	15 [2]	MN/m ² /m
Shear modulus of granular fill	G_{to} and G_{bo}	652.4 [3]	KN/m ²
Velocity of applied load	v	40 – 140	Km/hr
Thickness of granular fill layers	H_t and H_b	0.15	m
Ultimate bearing capacity of the poor foundation soil	q_u	20 – 60	KN/m ²
Ultimate shear resistance of granular fill	τ_{ut} and τ_{ub}	6	KN/m ²
Half-length of beam	L	150	m
Coefficient of lateral earth pressure	K	0.172	-
Interfacial friction coefficient at top and bottom reinforcement.	μ_t and μ_b	0.5	-

For a typical set of parameters, i.e., $P^* = 5 \times 10^{-7}$, $G_{to}^* = G_{bo}^* = 3 \times 10^{-7}$, $I^* = 6 \times 10^{-10}$, $\tau_{ut}^* = \tau_{ub}^* = 2.7 \times 10^{-9}$, $q_u^* = 1.8 \times 10^{-5}$, $\rho^* = 1.2 \times 10^{-7}$, $\mu_t = \mu_b = 0.5$ and $K = 0.172$, the comparison of nonlinear responses of the tension and tensionless extensible geosynthetic resting on nonlinearity in the behavior at poor soil which responds in infinite beam in terms of normalized deflection, normalized mobilized tension in geosynthetic layer, normalized bending moment, normalized soil reaction has been presented in Figs. 4-7. As expected, the deflection of beam has been found to increase the negative deflection of beam as the analysis considers tensionless extensible geosynthetic nonlinearity in the behavior at poor soil (Figs. 4 (a) & (b)). The maximum negative normalized deflection increase from 2.85×10^{-6} to 3.2×10^{-6} ; it can be observed that the soil uniformly responding to tension under the nonlinear behavior of poor soil (Tensionless foundation) as shown in Fig. 4 (b). So it is clear that a tensionless foundation affects the uniformly lift up of the beam (negative deflection) more as compared to its settlement (positive deflection). The comparisons is also made with respect to normalized bending moment of the beam and normalized and mobilized tension in geosynthetic layer in Figs. 5 and 6 respectively for the same parameters as in case of deflection of beam. The maximum positive normalized bending moment is almost same for both the cases but the negative normalized bending moment decrease by around 8% in case of soil unable to take any tension under the nonlinear behavior of poor soil. The normalized mobilized tension is significantly affected and is negligible in case of tension foundation under the nonlinearity soil. The mobilized tension at the point of loading increases 10% when the soil react the tension and compression.

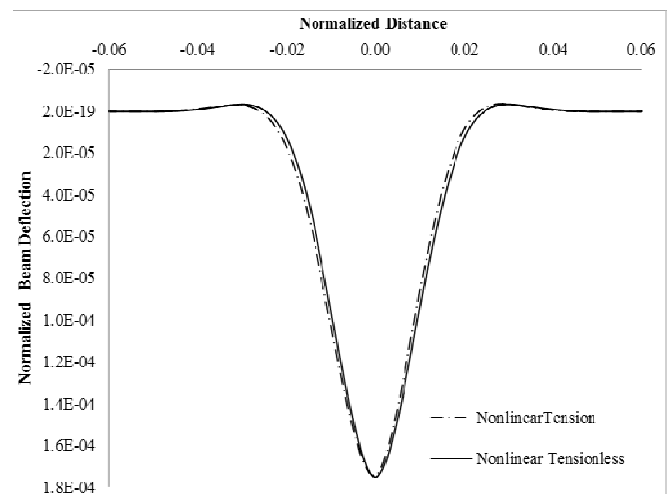

Fig. 4 (a) Typical Settlement profiles for soil responding to tension and soil not responding to tension (Tensionless Foundation)

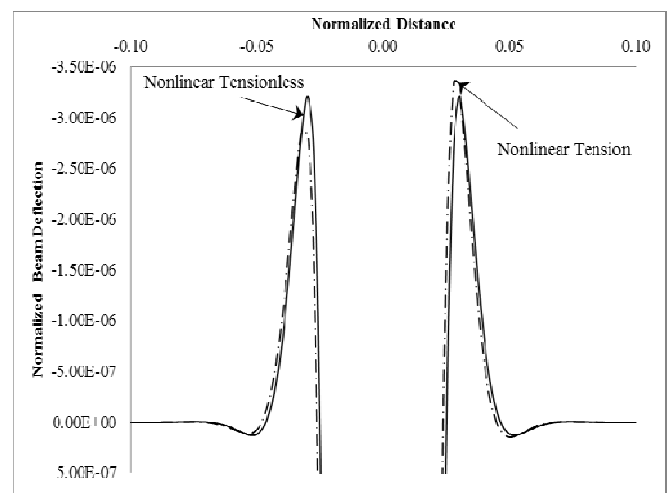

Fig. 4 (b) Typical negative settlement profiles for soil responding to tension and soil not responding to tension (Tensionless foundation)

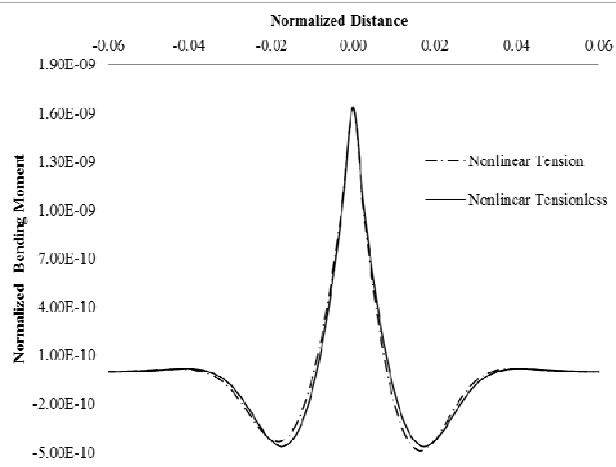

Fig. 5 Typical bending moment of beam for soil responding to tension and soil not responding to tension

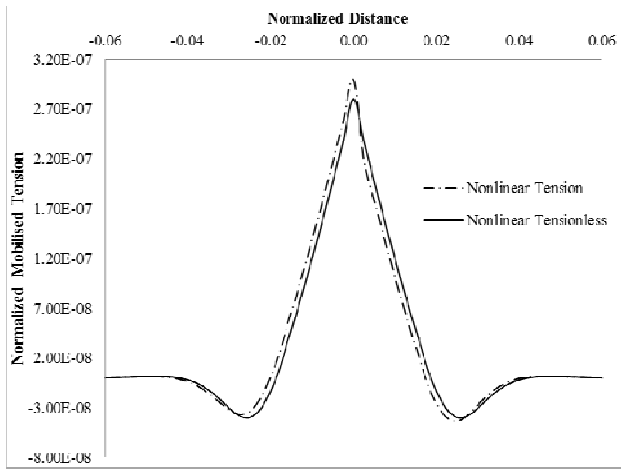

Fig. 6 Typical mobilized tension of geosynthetic for soil responding to tension and soil not responding to tension

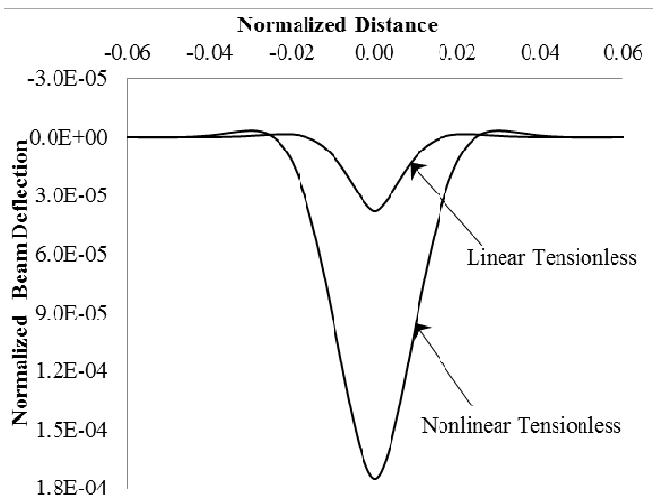

Fig. 7 Typical Settlement profiles for linear and nonlinear response of tensionless extensible geosynthetic reinforced earth beds

Figs. 7-10 show the comparison of linear and nonlinear response of the infinite beam and geosynthetic resting on poor

soil which responds only in compression (Tensionless foundation) to that of soil for typical parameters, i.e., $P^*=5 \times 10^{-7}$, $G_{to}^*=G_{bo}^*=3 \times 10^{-7}$, $I^*=6 \times 10^{-10}$, $\tau_{ut}^*=\tau_{ub}^*=2.7 \times 10^{-9}$, $\mu_t=\mu_b=0.5$, $q_u^*=1.8 \times 10^{-5}$, $\rho^*=1.2 \times 10^{-7}$ and $K=0.172$. As expected, the deflection of infinite beam has been found to reduce as the analysis considers non-linearity in the behavior at poor soil (Fig. 7). The reduction in maximum deflection has been found to be 82.6%. Fig. 8 depicts the variation of bending moment along the length of the beam. Maximum normalized bending moment has been found to reduce by 48% as the analysis considers linearity in the behavior of soil. Fig. 9 compares the mobilized tension in geosynthetic layer for linear and nonlinear analysis. The maximum mobilized tension has been found to be more for linear analysis as compared to that for nonlinear analysis. However, the extent of mobilized tension in geosynthetic layer has been observed to be more in case of nonlinear analysis.

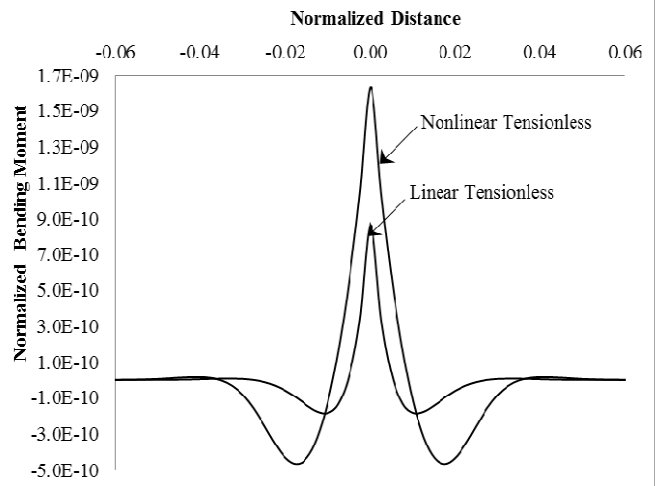

Fig. 8 Typical bending moment of beam for linear and nonlinear response of tensionless extensible geosynthetic reinforced earth beds

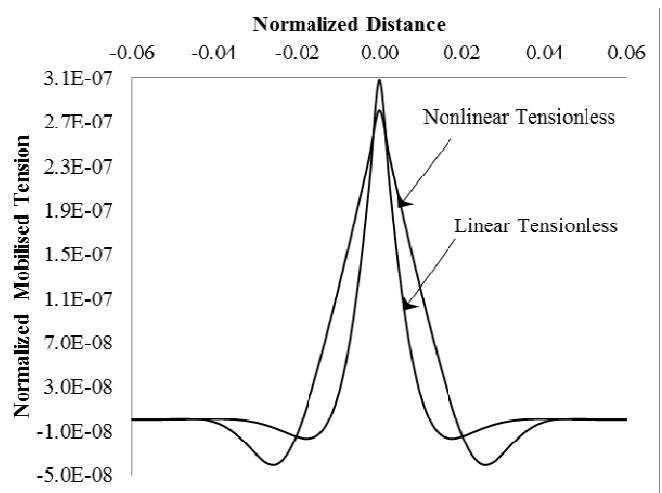

Fig. 9 Typical mobilized tension of geosynthetic for linear and nonlinear response of tensionless extensible geosynthetic reinforced earth beds

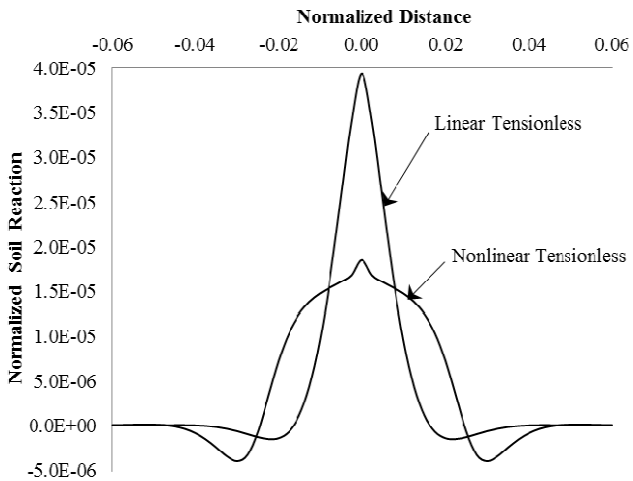

Fig. 10 Typical soil reaction variation for linear and nonlinear response of tensionless extensible geosynthetic reinforced earth beds

Comparison between linear and nonlinear analysis with respect to soil reaction on the beam has been presented in Fig. 10. Maximum soil reaction for nonlinear analysis has been found to be about 55% less than that for linear analysis. The extent of soil reaction on either side of applied load has been found to more in nonlinear analysis.

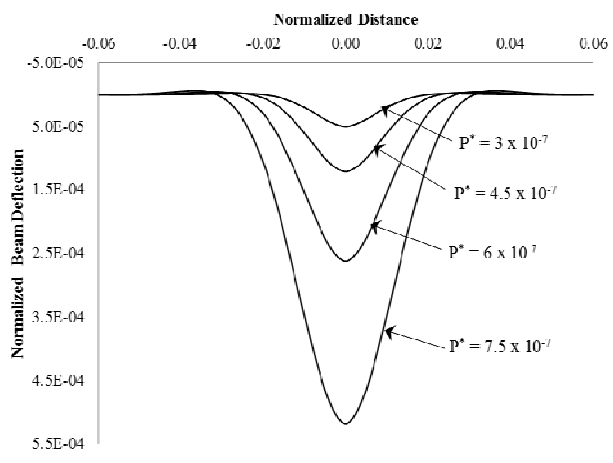

Fig. 11 Typical settlement profile for various load intensity

Figs. 11 & 12 show the effect of magnitude of applied load on deflection and bending moment respectively for the parameters, i.e. $G_{to}^* = G_{bo}^* = 3 \times 10^{-7}$, $I^* = 6 \times 10^{-10}$, $\tau_{ut}^* = \tau_{ub}^* = 2.7 \times 10^{-9}$, $\mu_t = \mu_b = 0.5$, $K = 0.172$, $q_u^* = 1.8 \times 10^{-5}$ and $\rho^* = 1.2 \times 10^{-7}$. The normalized magnitude of applied load has been varied from 3×10^{-7} to 7.5×10^{-7} and corresponding reduction in the maximum deflection of beam has been found to be 91% (Fig. 11). It can be seen that deflection of the ground surface becomes zero when the deflection of the beam is negative, i.e., when beam gets lifted up; there is a separation between the beam and the ground surface. The corresponding reduction in maximum normalized bending moment in the beam has been found to be 95.7% (Fig. 12). Any increase in magnitude of load intensity causes more deflection and hence more bending

moment. The influence of applied load on the tension mobilized in geosynthetic layer has been depicted in Fig. 13.

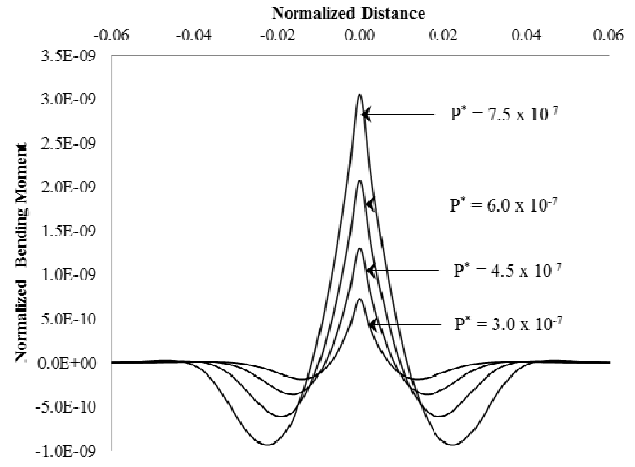

Fig. 12 Typical bending moment of beam for various load intensity

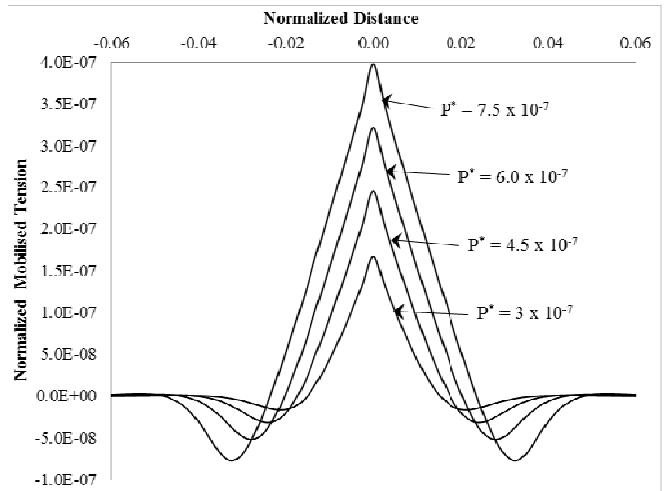

Fig. 13 Typical mobilized tension of geosynthetic for various load intensity

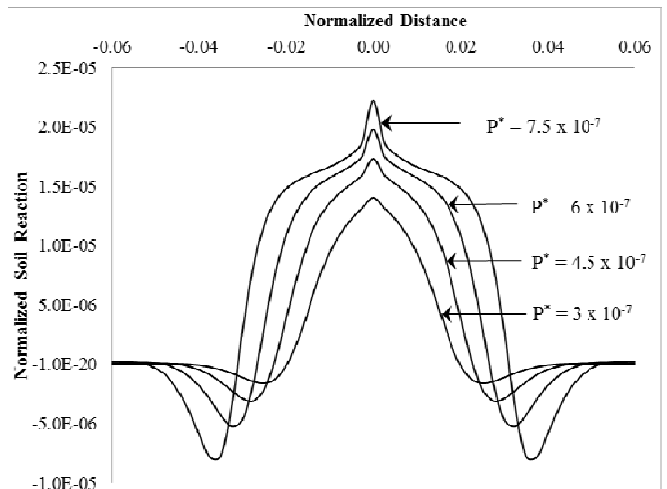

Fig. 14 Typical soil reaction variations for various load intensity

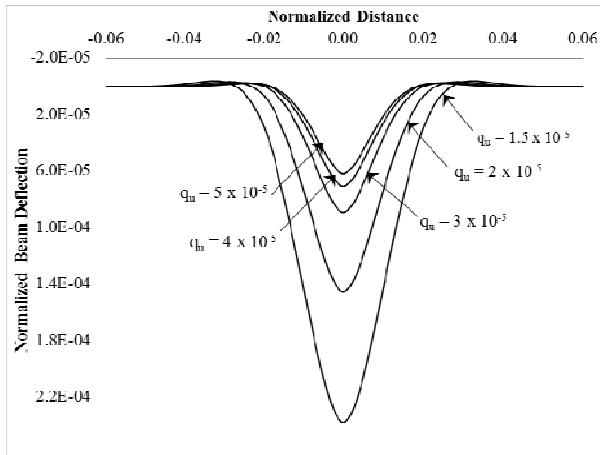

Fig. 15 Typical settlement profiles for various soil reactions

The maximum mobilized tension occurs at the point of application of load and reduces on either side. This has been found to reduce by 62.5 % as the applied load reduces from 7.5×10^{-7} to 3×10^{-7} . Soil reaction has been shown in Fig. 14 for different values of applied load as considered and the reduction in maximum soil reaction has been found to be about 39.7% for the reduction in applied load from 7.5×10^{-7} to 3×10^{-7} .

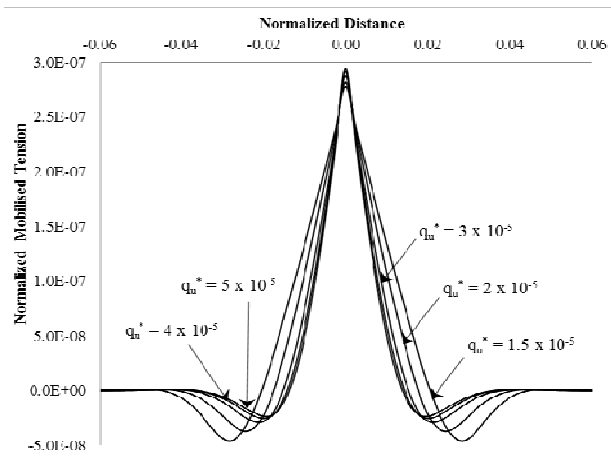

Fig. 16 Typical mobilized tension of geosynthetic for various soil reactions

The influence of ultimate resistance of poor soil on response of soil- foundation system has been depicted in Figs. 15-17 for parameters, i.e., $P^* = 5 \times 10^{-7}$, $G_{to}^* = G_{bo}^* = 3 \times 10^{-7}$, $K = 0.172$, $I^* = 6 \times 10^{-10}$, $\tau_{ut}^* = \tau_{ub}^* = 2.7 \times 10^{-9}$, $\mu_t = \mu_b = 0.5$ and $\rho^* = 1.2 \times 10^{-7}$. It can be observed that ultimate resistance of poor soil significantly affect the response of system under consideration. The maximum normalized deflection has been found to reduce by 75 % (Fig. 15) as the normalized ultimate resistance of poor soil increase from 1.5×10^{-5} to 5×10^{-5} . Fig. 16 shows the effect of parameter q_u^* on normalized mobilized tension in geosynthetic layer. As expected, the mobilized tension has been found to reduce with an increase in the parameter, q_u^* . The deflection of reduces with an increase in

the parameter q_u^* and this results into an increase in mobilized tension in geosynthetic layer. A reduction of about 13 % in tension mobilized has been observed corresponding to an increase in q_u^* from 1.5×10^{-5} to 5×10^{-5} . The corresponding reduction in maximum normalized bending moment has been found to be about 44 % (Fig. 17).

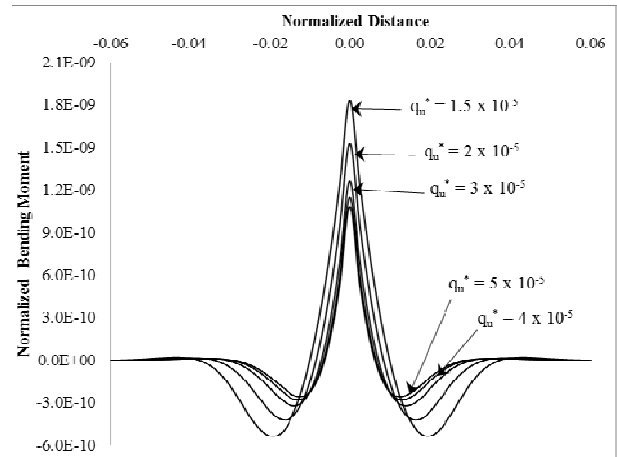

Fig. 17 Typical bending moment of beam for various soil reactions

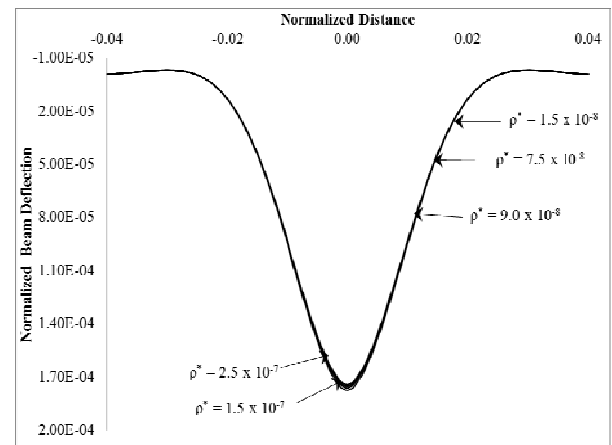

Fig. 18 Typical settlement profiles for various velocity values

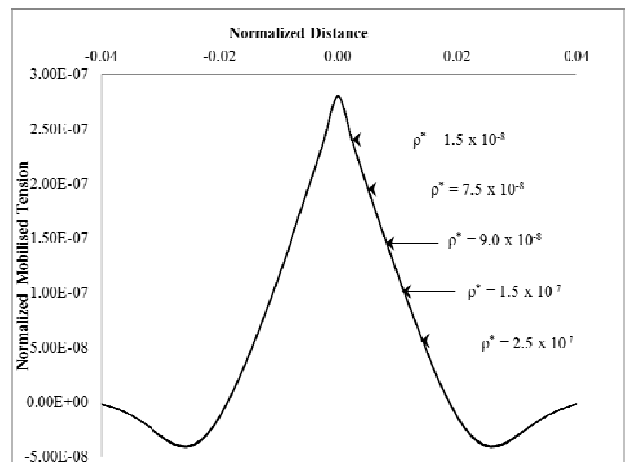

Fig. 19 Typical mobilized tension of geosynthetic for various velocity values

Effect of velocity of applied load, for parameters, i.e., $P^* = 5 \times 10^{-7}$, $G_{to}^* = G_{bo}^* = 3 \times 10^{-7}$, $\tau_{ut}^* = \tau_{ub}^* = 2.7 \times 10^{-9}$, $I^* = 6 \times 10^{-10}$, $\mu_t = \mu_b = 0.5$, $K = 0.172$, and $q_u^* = 1.8 \times 10^{-5}$ on the deflection profile of infinite beam has been studied for the parameter ρ^* varying from 1.5×10^{-8} to 2.5×10^{-7} . Figs. 18–20 depict the response of soil – foundation system. It can be observed that for the considered range of velocity, the response is not affected by any variation in the velocity.

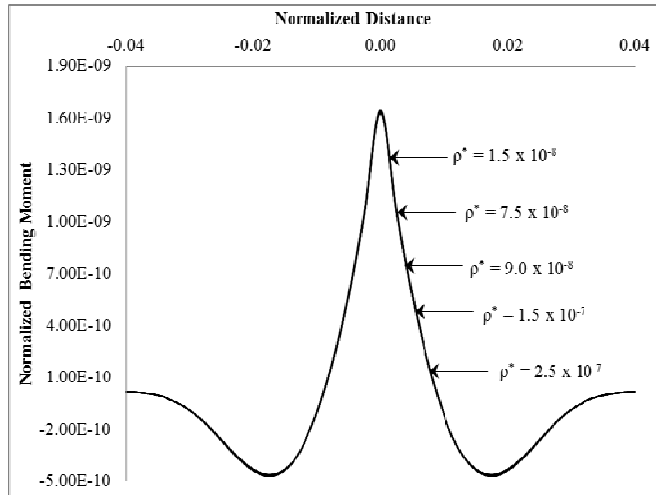

Fig. 20 Typical bending moment of beam for various velocity values

VII. CONCLUSIONS

The proposed model analysis an infinite beam resting on tensionless extensible geosynthetic reinforced granular fill poor soil system under a concentrated load moving with constant velocity is presented. The analysis takes into account tensionless extensible geosynthetic and the nonlinear behavior of granular fill and the natural occurring poor soil. Thus, the separation of the beam from the ground surface has been incorporated in the present approach.

Based on the results and discussion presented in the previous section, the following generalized conclusions as given follows;

- 1) The lift up of the beam (negative deflection) and the mobilized tension in the geosynthetic layer for the tensionless foundation are observed uniformly reduction as compared to the foundation reacting on compression as well as tension.
- 2) The response of the soil - foundation under consideration is greatly affected by the inclusion of nonlinearity in granular fill and the poor soil.
- 3) It is observed that the deflection, bending moment in the beam, mobilized tension and the soil reaction increases with the load intensity and in proportion to the increase in the applied load.
- 4) As the parameter ρ^* (representing velocity of applied load) decreases from 1.5×10^{-8} to 2.5×10^{-7} , the maximum normalized deflection of the beam can reduce by about 8 % for the range of parameters considered in the study.

- 5) The ultimate resistance of poor soil has been found to significantly affect the response of infinite beam and the geosynthetic layer. Deflection (about 75 %) and bending moment in the beam (about 44%) has been found to reduce with an increase in the ultimate resistance of poor soil. Tension mobilized in the geosynthetic layer has been found to reduce by extent 13% for an increase in parameter q_u^* from 1.5×10^{-5} to 5×10^{-5} .

REFERENCES

- [1] Basu, D. (2001), "Soil structure interaction analysis due to moving load". *M.Tech. Thesis, Department of Civil Engineering, Indian Institute of Technology, Kanpur, India.*
- [2] Das, B.M. (1999), "Principles of foundation engineering", 4th Edition, PWS Publishing, USA.
- [3] Desai C.S. and Abel J.F. (1987), "Introduction to the finite element method: a numerical method for engineering analysis", CBS Publishers and Distributors, India.
- [4] Ghosh C, Madhav MR., "Reinforced granular fill-soft soil system: confinement effect", *Geotext Geomembrane* 1994; 13:727–41.
- [5] Ghosh C, Madhav MR., "Reinforced granular fill-soft soil system: membrane effect", *Geotext Geomembrane* 1994; 13:743–59.
- [6] Kenney, J.T. Jr (1954), "Steady-state vibrations of beam on elastic foundation for moving load", *Journal of Applied Mechanics Division, Transactions of American Society of Mechanical Engineers*, vol. 21, pp. 359–364.
- [7] Kondner, R.L. and J.S. Zelasko. (1963), "A hyperbolic stress-strain response: cohesive soil", *Journal of the Soil Mechanics and Foundations Division, ASCE*, 89(SM1):115-143
- [8] Shahu JT, Madhav MR, Hayashi S., "Analysis of soft ground granular pile-granular mat system", *Comput Geotech* 2000; 27(1):45–62.
- [9] Madhav MR, Poorooshab HB., "A new model for geosynthetic reinforced soil", *Comp Geotech* 1988; 6:277–90.
- [10] Madhav MR, Poorooshab HB., "Modified Pasternak model for reinforced soil". *International J Math Modelling* 1989; 12(12):1505–9.
- [11] Shukla SK, Chandra S., "The effect of prestressing on the settlement characteristics of geosynthetic-reinforced soil", *Geotext Geomembrane* 1994; 13:531–43.
- [12] Shukla SK, Chandra S., "A study of settlement response of a geosynthetic-reinforced compressible granular fill-soft soil system", *Geotext Geomembrane* 1994; 13:627–39.
- [13] Shukla SK, Chandra S., "A generalized mechanical model for geosynthetic-reinforced foundation soil", *Geotext Geomembrane* 1994; 13:813–25.
- [14] Yin JH. "Modeling of geosynthetic-reinforced granular fill over soft soil". *Geosynthetic International* 1997; 4(2): 165-85.
- [15] Yin JH. "A nonlinear model of geosynthetic-reinforced granular fill over soft soil", *Geosynthetic International* 1997; 4(5): 523-37.
- [16] Yin JH, "Closed form solution for reinforced Timoshenko beam on elastic foundation", *J Appl Mech Div Trans, Am Soc Mech Eng* 2000; 12(8): 868-74.
- [17] Zhan C, Yin JH., "Elastic analysis of soil-geosynthetic interaction", *Geosynthetic International* 2001; 8(1):27–48.