

A Second Law Assessment of Organic Rankine Cycle Depending on Source Temperature

Kyounghoon Kim

Abstract—Organic Rankine Cycle (ORC) has potential in reducing fossil fuels and relaxing environmental problems. In this work performance analysis of ORC is conducted based on the second law of thermodynamics for recovery of low temperature heat source from 100°C to 140°C using R134a as the working fluid. Effects of system parameters such as turbine inlet pressure or source temperature are theoretically investigated on the exergy destructions (anergies) at various components of the system as well as net work production or exergy efficiency. Results show that the net work or exergy efficiency has a peak with respect to the turbine inlet pressure when the source temperature is low, however, increases monotonically with increasing turbine inlet pressure when the source temperature is high.

Keywords—Organic Rankine cycle (ORC), low temperature heat source, exergy, source temperature.

I. INTRODUCTION

AS it is impossible to convert low temperature heat source to electricity efficiently by conventional methods, most of the low temperature energy is just discarded. Therefore the research is important how to generate electricity efficiently from low grade energy sources. In recent years the organic Rankine cycle (ORC) and the power generating system using binary mixture as a working fluid have attracted much attention as they are proven to be the most feasible methods to achieve high efficiency in converting the low-grade thermal energy to more useful forms of energy [1], [2].

ORC is a Rankine cycle where an organic fluid is used instead of water as working fluid. The ORC is not a new concept and many investigations have been carried out, ORC has become a field of intense research in recent years due to great flexibility, high safety and low maintenance requirements in recovering low grade of heat [3], [4]. The working fluids used in ORC can be categorized into three groups of wet, dry and isentropic fluids. The dry fluids have disadvantages of reduction of net work due to superheated vapor at turbine exit, and wet fluids of the moisture content at turbine inlet, so isentropic fluids are to be preferred [5].

Drescher and Bruggemann [4] proposed a method to find suitable thermodynamic fluids for ORCs in biomass plants and found that the family of alkylbenzenes showed the highest efficiency. Schuster et al. [6] investigated various applications such as geothermal power plant; biomass fired combined heat and power plants, solar desalination plants, waste heat recovery or micro CHP. Heberle and Brueggemann [7] investigate the combined heat and power generation for geothermal re-sources

with series and parallel circuits of an ORC. Dai et al. [8] used a generic optimization algorithm, identified isobutane and R236ea as efficient working fluids. Tchanche et al. [9] conducted comparative performance analysis of solar organic Rankine cycle using various working fluids.

In ORC temperature matching to the source stream is important in minimizing the irreversibilities caused by heat transfer across a finite temperature difference. When using the ORC to produce electricity from a finite thermal reservoir though, temperature mismatching often is inevitable because the source stream is single-phase and possesses a near linear temperature profile along the heat exchanger. Ho et al. [10], [11] proposed a new cycle named as organic flash cycle (OFC) where heat is transferred to the ORC until the working fluid reaches a saturated liquid state and the fluid would then be flash evaporated to produce a two-phase mixture.

Exergy is a measure of the departure of the state of a system from that of the environment, and the method of exergy analysis is well suited for furthering the goal of more energy resource use, for it enables the location, cause, and true magnitude of waste and loss to be determined [12]-[15]. This work presents thermodynamic performance analysis based on the second law of thermodynamics for ORC to convert low temperature heat source to useful energy by using R134a as the working fluid. Effects of important system including the turbine inlet pressure and the source temperature are theoretically investigated on the exergy destructions at various components of the system as well as net work production or exergy efficiency.

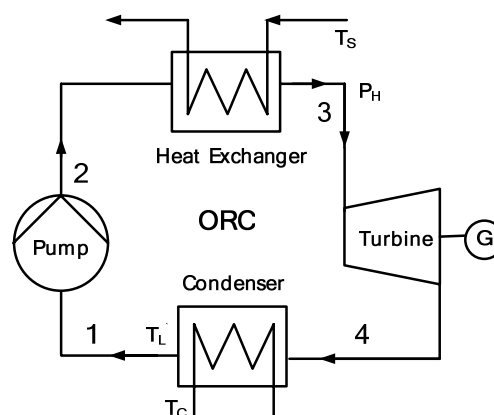

Fig. 1 Schematic diagram of the system

II. SYSTEM ANALYSIS

The schematic diagram of the system is shown in Fig. 1. The

K. H. Kim is with Dept. Mech. Eng., Kumoh National Institute of Technology, 61 Daehakro, Gumi, Gyeongbuk 730-701, Korea (phone: 82-54-478-7292; fax: 82-54-478-7319; e-mail: khkim@kumoh.ac.kr)

system consists of pump, heat exchanger, turbine and condenser. A low temperature heat source is supplied to the system as sensible heat energy. The working fluid considered in this work is R134a. In this work the thermodynamic properties of the working fluids are calculated using the Patel-Teja equation of state [16], [17]. The basic data of the fluid which are needed to calculate the thermodynamic properties are as follows; molar mass (M) is 102.031 kg/kmol, critical temperature (T_c) 380.0 K, critical pressure (P_c) 3.69 MPa, and acentric factor (ω) 0.239 [18].

The coolant enters the condenser at temperature of T_c and the working fluid leaves the condenser as saturated liquid at T_L (state 1) where the corresponding saturation pressure P_L is the low pressure of the system. The fluid is compressed with the pump to P_H which is the high pressure of the system (point 2). The heat source is supplied at temperature of T_s and the fluid is heated with the heat exchanger and leaves the heat exchanger as saturated liquid at pressure, $P_3 = P_H$ (state 3). Then the vapor is expanded in the turbine to the pressure of P_L (point 4). In this study it is assumed that the minimum temperature difference between hot and cold streams in the source heat exchanger or condenser is the prescribed value of pinch point, ΔT_{pp} . The thermodynamic properties at points 2 and 4 can be obtained in terms of the isentropic efficiencies of pump and turbine, η_p and η_t , respectively.

The ratio of mass flow rate of working fluid to source, r_s and that of coolant to working fluid, r_c can be determined as

$$r_s = \frac{\dot{m}_{wf}}{\dot{m}_s} = \frac{c_{ps}(T_s - T_{s,out})}{h_3 - h_2} \quad (1)$$

$$r_c = \frac{\dot{m}_c}{\dot{m}_{wf}} = \frac{h_7 - h_1}{c_{pc}(T_{c,out} - T_c)} \quad (2)$$

where subscripts wf, s and c denote the working fluid, the source fluid and outlet, respectively, and m the mass flow rate, T the temperature, h the specific enthalpy, and c_{ps} and c_{pc} the constant pressure specific heat of source and coolant, respectively.

Then the rate of heat addition \dot{Q}_{in} , heat rejection \dot{Q}_{out} , and net work \dot{W}_{net} are obtained as

$$\dot{Q}_{in} = \dot{m}_{wf}(h_3 - h_2) \quad (3)$$

$$\dot{Q}_{out} = \dot{m}_{wf}(h_3 - h_4) \quad (4)$$

$$\dot{W}_{net} = \dot{W}_t - \dot{W}_p = \dot{m}_{wf}[(h_3 - h_4) - (h_2 - h_1)] \quad (5)$$

where the subscripts t and p denotes the turbine and pump, respectively.

The specific exergy e and the rate of exergy input \dot{E}_{in} to the system by source fluid can be calculated as

$$e = h - h_0 - T_0(s - s_0) \quad (6)$$

$$\dot{E}_{in} = \dot{m}_s c_{ps} \{T_s - T_0 - T_0 \ln(T_s / T_0)\} \quad (7)$$

where s is the specific entropy and subscript 0 refers the dead

state. Then, the exergy efficiency of the system η_{ex} , which is defined as the ratio of net work to exergy input, can be written as follows.

$$\eta_{ex} = \dot{W}_{net} / \dot{E}_{in} \quad (8)$$

The exergy destruction or anergy of the adiabatic system is calculated as the difference of exergy input and output. The anergy ratio at a system component is defined as the ratio of anergy there to the exergy input by source fluid. Then summation of all anergy ratios of the system and the exergy efficiency becomes unity.

$$\eta_{ex} + D_{he} + D_{ho} + D_{cd} + D_{co} + D_{wnet} = 1 \quad (9)$$

where D_{he} , D_{ho} , D_{cd} , D_{co} and D_{wnet} are anergy ratio of the heat exchanger, source exhaust, condenser, coolant exhaust, and net work (turbine and pump), respectively.

III. RESULTS AND DISCUSSIONS

TABLE I
 BASIC CALCULATION CONDITIONS

symbol	Parameter	data	unit
T_s	source temperature	100-140	°C
T_c	coolant temperature	25	°C
T_L	condensing temperature	40	°C
T_0	ambient temperature	25	°C
ΔT_{pp}	pinch point	10	°C
η_p	isentropic efficiency of pump	0.80	
η_t	isentropic efficiency of turbine	0.80	
	source	water	

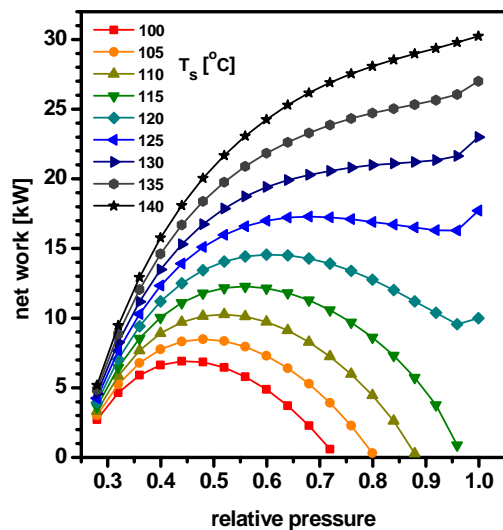

Fig. 2 Net work production

The basic system parameters used in the simulation of this work are summarized in Table I. For various sources temperatures, the net work production of the system is plotted in Fig. 4 against the relative pressure which is defined as the ratio of turbine inlet pressure to the critical pressure of the

working fluid as $P_r = P_H / P_c$. It can be seen from the figure that as the relative pressure increases, the network firstly increases and reaches a local maximum value and the decreases again when the source temperature is low, thus it has a peak value with respect to the turbine inlet pressure. However, the net work increases monotonically with increasing the relative pressure when the source temperature is high. For a specified relative pressure, the net work increases with increasing source temperature. It can be observed from the figure that when the source temperature is low, there exists an upper limit of the relative pressure. This is because as the relative pressure increases, the corresponding turbine inlet temperature also increases and consequently the temperature difference between the source fluid and the turbine inlet temperature decreases.

Fig. 3 shows the total energy of the system with respect to the relative pressure for various source temperatures. The total energy consists of the exergy destructions of the source heat exchanger, source exhaust, net work production, condenser and coolant exhaust. When the source temperature is low, the total energy has a local minimum value with respect to the relative pressure and the minimum value occurs at a low relative pressure. When the source temperature is high, however, the total energy decreases monotonically with increasing the relative pressure. Therefore, for a specified relative pressure, the total energy increases generally with increasing source temperature. But when the relative pressure is high, namely, when the turbine inlet pressure approaches the critical pressure of the working fluid, the total energy decreases first and reaches a minimum value and the increases again as the source temperature increases.

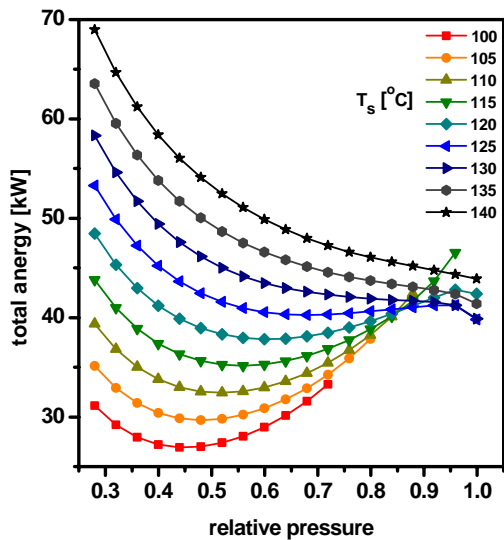

Fig. 3 Total energy of the system

Effects of the relative pressure on the exergy efficiency are shown in Fig. 4 for various source temperatures. The exergy efficiency is defined as the ratio of the net work production of the system to the exergy input by the source fluid as (8). When the source temperature is low, the exergy efficiency has a local maximum value with respect to the relative pressure. When the

source temperature is high, however, the exergy efficiency increases simply with increasing the relative pressure. For a specified relative pressure, the exergy efficiency increases with increasing source temperature, however, the increasing effect becomes insignificant when the relative pressure is low.

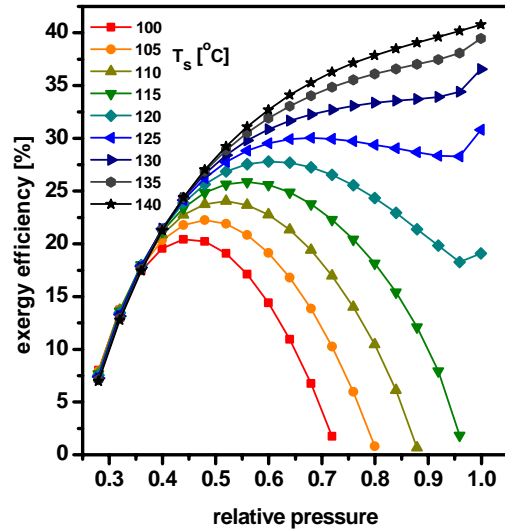

Fig. 4 Exergy efficiency of the system

Fig. 5 shows the anergy ratio of source heat exchanger as a function of the relative pressure for various source temperatures. It can be seen from the figure that the anergy ratio of the heat exchanger decreases with increasing relative pressure or decreasing source temperature. Furthermore, when the relative pressure is low, the anergy ratio of heat exchanger is the biggest among all of the anergy ratios of the system. This is because the temperature difference between the input source and input working fluid at the heat exchanger becomes large when the turbine inlet pressure is low.

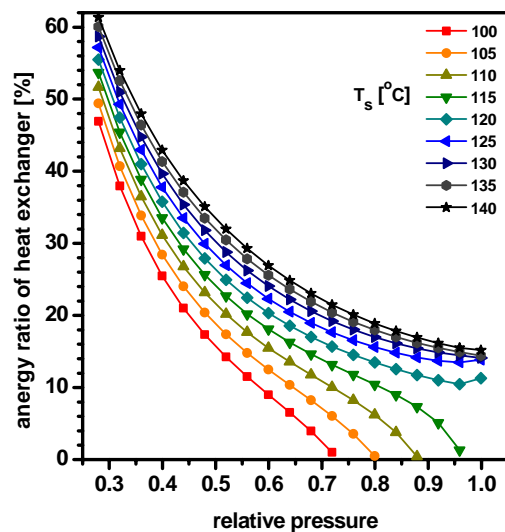

Fig. 5 Anergy ratio of heat exchanger

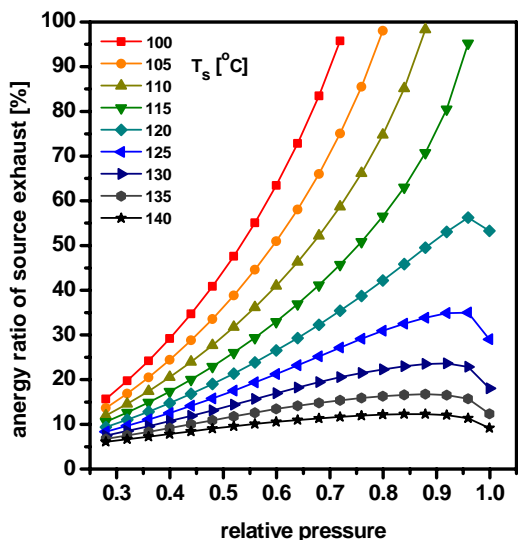

Fig. 6 Energy ratio of source exhaust

Fig. 6 shows the energy ratio of the source exhaust as a function of the relative pressure for various source temperatures. The energy ratio of the source exhaust has a local maximum value with respect to the relative pressure and the maximum value occurs generally at a high relative pressure. For a specified relative pressure, the energy ratio decreases with increasing source temperature. It is worth to note that when the relative pressure is low, the energy ratio of source exhaust is the biggest among all of the energy ratios of the system. This is because a high turbine inlet pressure results in the high corresponding turbine inlet temperature, and consequently the exhaust source fluid of high temperature.

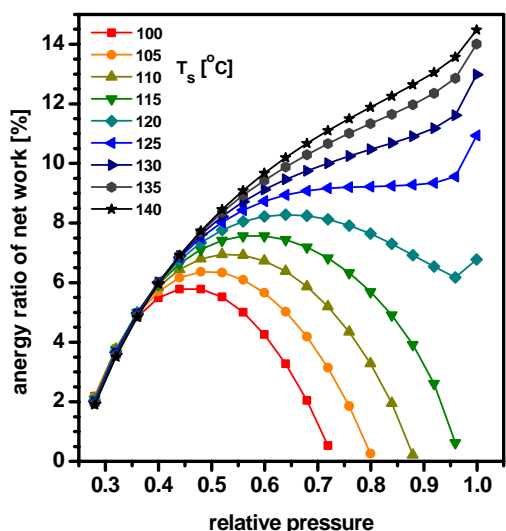

Fig. 7 Energy ratio of net work production

Effects of the relative pressure on the energy ratio of the net work are shown in Fig. 7 for various source temperatures. When the source temperature is low, the energy ratio has a peak value with respect to the relative pressure. However, when the source temperature is high, the energy ratio increases

monotonically with increasing relative pressure. For a specified relative pressure, the energy ratio increases with increasing source temperature. It can be observed from the Figs. 2 and 7 that the behaviors of the energy ratio of net work with respect to the parameters are similar to those of the net work.

IV. CONCLUSION

In this paper, the performance of ORC is analyzed based on the second law of thermodynamics depending on the source temperature. The main results are as follows:

- 1) When the source temperature is low, the total energy has a local minimum value with respect to the turbine inlet pressure. When the source temperature is high, however, the total energy decreases monotonically with increasing the relative pressure.
- 2) When the source temperature is low, the net work production or the exergy efficiency of the system has a local minimum value with respect to the turbine inlet pressure.
- 3) When the source temperature is high, the net work or the exergy efficiency increases monotonically with increasing the turbine inlet pressure.
- 4) The energy ratio of the source heat exchanger is the biggest among the energy ratios of the system when the turbine inlet pressure is low, whereas the energy ratio of the source exhaust is the biggest when the turbine inlet pressure is low.

ACKNOWLEDGMENT

This research was supported by Basic Science Research Program through the National Research Foundation of Korea (NRF) funded by the Ministry of Education, Science and Technology (No. 2010-0007355).

REFERENCES

- [1] K. H. Kim, C. H. Han and K. Kim, "Effects of ammonia concentration on the thermodynamic performances of ammonia-water based power cycles," *Thermochimica Acta*, vol. 530, pp. 7-16, 2012.
- [2] K. H. Kim, H. J. Ko and K. Kim, "Assessment of pinch point characteristics in heat exchangers and condensers of ammonia-water based power cycles," *Applied Energy*, Vol. 113, pp. 970-981, 2014.
- [3] K. H. Kim and C. H. Han, "Analysis of transcritical organic Rankine cycles for low-grade heat conversion," *Adv. Sci. Lett.*, vol. 8, pp. 216-221, 2012.
- [4] U. Drescher and D. Brüggemann, "Fluid selection for the organic Rankine cycle (ORC) in biomass power and heat plants," *App. Therm. Eng.*, vol. 27, pp. 223-228, 2007.
- [5] T. C. Hung, S. K. Wang, C. H. Kuo, B. S. Pei, and K. F. Tsai, "A study of organic working fluids on system efficiency of an ORC using low-grade energy sources," *Energy*, vol. 35, pp. 1403-1411, 2010.
- [6] A. Schuster, S. Karellas, and H. Splithoff, "Energetic and economic investigation of innovative Organic Rankine Cycle applications," *App. Therm. Eng.*, vol. 29, pp. 1809-1817, 2008.
- [7] F. Heberle and D. Brüggemann, "Exergy based fluid selection for a geothermal organic Rankine cycle for combined heat and power generation," *App. Therm. Eng.*, vol. 30, pp. 1326-1332, 2010.
- [8] Y. Dai, J. Wang, and L. Gao, "Parametric optimization and comparative study of organic Rankine cycle (ORC) for low grade waste heat recovery," *Energy Convs. Mgmt.*, vol. 50, pp. 576-582, 2009.
- [9] B. F. Tchanche, G. Papadakis, and A. Frangoudakis, "Fluid selection for a low-temperature solar organic Rankine cycle," *App. Therm. Eng.* vol. 29, pp. 2468-2476, 2009.

- [10] T. Ho, S. S. Mao and R. Greif, "Comparison of the Organic Flash Cycle (OFC) to other advanced vapor cycles for intermediate and high temperature waste heat reclamation and solar thermal energy," *Energy*, vol. 42, pp. 213-223, 2012.
- [11] T. Ho, S. S. Mao and R. Greif, "Increased power production through enhancements to the Organic Flash Cycle (OFC)," *Energy*, vol. 45, pp. 686-695, 2012.
- [12] A. Bejan, G. Tsatsaronis and M. Moran, "*Thermal design and optimization*," John Wiley & Sons, 1996.
- [13] K. H. Kim, H. J. Ko and H. Perez-Blanco, "Exergy analysis of gas-turbine systems with high fogging compression," *Int. J. Exergy*, vol. 8, pp. 16-32, 2011.
- [14] K. H. Kim and K. Kim, "Exergy analysis of overspray process in gas turbine systems," *Energies*, vol. 5, pp. 2745-2758, 2012.
- [15] K. H. Kim, C. H. Han and K. Kim, "Comparative Exergy Analysis of Ammonia-Water based Rankine Cycles with and without Regeneration," *Int. J. Exergy*, in press, 2013.
- [16] T. Yang, G. J. Chen, and T. M. Guo, "Extension of the Wong- Sandler mixing rule to the three-parameter Patel-Teja equation of state: Application up to the near-critical region," *Chem. Eng. J.* vol. 67, pp. 27-36, 1997.
- [17] J. Gao, L. D. Li, Z. Y. Zhu, and S. G. Ru, "Vapor-liquid equilibria calculation for asymmetric systems using Patel-Teja equation of state with a new mixing rule," *Fluid Phase Equilibria*, vol. 224, pp. 213- 219, 2004.
- [18] C. L. Yaws, *Chemical properties handbook*, McGraw- Hill, 1999.