

Performance Evaluation of GPS \ INS Main Integration Approach

Othman Maklounf, Ahmed Adwaib

Abstract—This paper introduces a comparative study between the main GPS\INS coupling schemes, this will include the loosely coupled and tightly coupled configurations, several types of situations and operational conditions, in which the data fusion process is done using Kalman filtering. This will include the importance of sensors calibration as well as the alignment of the strap down inertial navigation system. The limitations of the inertial navigation systems are investigated.

Keywords—GPS, INS, Kalman Filter.

I. INTRODUCTION

AN Inertial Navigation System (INS) is a navigation aid that uses a computer, motion sensors (accelerometers) and rotation sensors (gyroscopes) to continuously calculate via dead reckoning the position, orientation, and velocity (direction and speed of movement) of a moving object without the need for external references. It is used on vehicles such as ships, aircraft, submarines, guided missiles, and spacecraft. Other terms used to refer to inertial navigation systems or closely related devices include inertial guidance system, inertial reference platform, inertial instrument, and many other variations [1]. All inertial navigation systems suffer from integration drift: small errors in the measurement of acceleration and angular velocity are integrated into progressively larger errors in velocity, which are compounded into still greater errors in position. Since the new position is calculated from the previous calculated position and the measured acceleration and angular velocity, these errors are cumulative and increase at a rate roughly proportional to the time since the initial position was input. Therefore the position must be periodically corrected by input from some other type of navigation system. Inertial navigation is usually used to supplement other navigation systems, providing a higher degree of accuracy than is possible with the use of any single system. For example, if, in terrestrial use, the initially tracked velocity is intermittently updated to zero by stopping, the position will remain precise for a much longer time, a so-called zero velocity update. Control theory in general and Kalman filtering in particular, provide a theoretical framework for combining information from various sensors. One of the most common alternative sensors is a satellite navigation radio, such as Global Positioning System (GPS). Limitations of GPS include occasional high noise content, outages when

satellite signals are blocked, interference and low bandwidth. The strengths of GPS include its long-term stability and its capacity to function as a stand-alone navigation system [2]. In contrast, inertial navigation systems are not subject to interference or outages, have high bandwidth and good short-term noise characteristics, but have long-term drift errors and require external information for initialization. A combined system of GPS and INS subsystems can exhibit the robustness, higher bandwidth and better noise characteristics of the inertial system with the long-term stability of GPS [3].

II. GPS/INS INTEGRATION SCHEMES

There is several integration strategies applied to INS/GPS integration and they are characterized by the type of information that is shared between the individual systems. The preferred integration strategy is typically defined by the quality of the INS used in the combined system. In practice, four well-known integration approaches are implemented in the navigation field: uncoupled, loosely coupled, tightly coupled and finally, ultra-tightly coupled integration [4]. Uncoupled integration implies no data feedback from either instrument to the other to facilitate its performance improvement. By contrast, in the ultra-tightly coupled approach, the sensors are treated as a common system, which produces several types of data that are processed simultaneously to enhance the function of individual sensor components. In a loosely coupled system, data from one instrument is fed back to aid and improve the other's performance, but each retains its own individual data processing algorithm throughout the interchange process [3].

In an uncoupled INS/GPS scheme, GPS measurements are used to compensate INS errors in the output of the integrated system only; the GPS information does not contribute to decreasing the error rate (i.e. there is no feedback of estimated INS errors into the navigation algorithm). Therefore, during GPS outages, the INS works in stand-alone mode and the accuracy of the integrated system degrades rapidly; the magnitude, i.e. the speed, of such degradation depends on the INS sensor quality. The uncoupled and loosely coupled integration schemes are characterized by the same degree of observability due to their identical system structures and measurement models. Because of the complex relationship between the measurements and the error states, tightly coupled integration is distinguished by a weaker degree of observability. The ultra-tight algorithm for INS/GPS integration is preferable in terms of the system performance in general. In this case, the GPS receiver and the INS no longer work independently, but they operate as a common system.

O. Maklounf is with the Department of Electrical Engineering, Engineering Academy Tajoura. Libya, (e-mail: omaklounf@yahoo.com).

A. Adwaib is with Electrical Engineering Department, Faculty of Engineering, Tripoli, University, Libya (e-mail: Ahmedadwaib@yahoo.com).

GPS updates are utilized to calibrate the INS, while the INS is used to aid the GPS receiver tracking loops during interference or other degraded signal conditions [3].

A. Loosely Coupled Integration

Loosely and tightly coupled integration algorithms are the most commonly applied for many surveying applications. In both cases, the GPS receiver and the INS operate as independent systems, and differ only in the type of information shared between them. The cascaded scheme is a well known, and frequently implemented, type of loosely coupled integration. In the cascaded scheme of integration, GPS data is fed to an INS-only filter. Usually, the differences between the INS and GPS velocities and positions are utilized as measurements for the estimation block, in which the INS error equations are used as the system model. In this way, the INS filter provides estimates of all observable INS errors, which are applied to correct INS raw measurements and to compensate them in the system output. When GPS measurements are not available, INS errors must be predicted [3]. The basic procedures in the loose integration method can be described through the following steps [5].

1. Processing of the raw GPS measurements through a GPS Kalman filter in order to determine the position and velocity from GPS, (r_{GPS}^n, V_{GPS}^n) .
2. Processing of the raw INS measurements, $(\Delta\theta_{ib}^b, \Delta V^b)$ through the mechanization equations in order to determine the position and velocity from INS, (r_{INS}^n, V_{INS}^n) .
3. Use of the position and velocity from (1) as input to an INS Kalman filter. The filter takes the difference between the position and velocity from (1) and (2), $(\Delta r^n, \Delta V^n)$ in order to determine the error estimates of the position and velocity, $(\delta r^n, \delta V^n)$ plus the misalignment error, (ϵ^n) .
4. Use the error estimates from (3) to update the position and velocity from (2) in order to get a full state vector, (r^n, V^n, R_b^n) .

The main advantage of the loosely coupled strategy lies in the relatively small dimensions of the state vectors in the filter, as compared to the tightly coupled case. This affects the filter convergence time, by shortening the transition period, so that the filter is more flexible for changes in operational environments. Another advantage of this approach is the computational simplicity of its implementation. However, the most important benefit comes from the flexibility and universality of the loosely coupled scheme for different types of INS and GPS units; e.g. herein for the two different types of GPS receivers deployed (conventional or HS GPS receivers) in distinct operational environments.

The disadvantage of loosely coupled integration is that, in general, a GPS receiver needs at least three satellites to compute the navigation solution (in height-constrained mode). Under harsh GPS conditions, GPS receivers experience

frequent losses of lock due to severe satellite blockage. As a result of regular GPS outages, the integrated system therefore offers a diminished degree of overall accuracy owing to the prediction mode of the INS filter. Nevertheless, the severity of such shortages is questionable and can also be considered as an advantage. In challenging GPS applications (e.g. downtown of big cities, forests), GPS measurements are corrupted significantly by many errors such as multipath, signal cross-correlation and echo-only signals. When GPS fails or provides an unreliable or erroneous solution, loose integration, operating essentially on two independent solutions, is more likely to detect these faults or consequent outliers and is better able to take appropriate remedial action. In consideration of the above, the loosely coupled integration strategy (that is, the cascaded scheme) is considered as more suitable for INS/GPS integration in various operating conditions, i.e. urban or open sky areas.

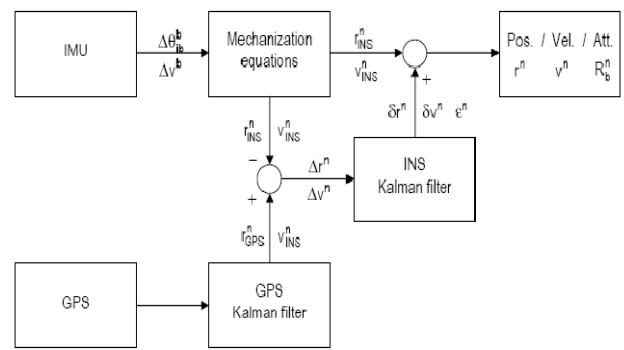

Fig. 1 Loosely coupled integration

B. Tightly Coupled Integration

Tightly coupled algorithm deals with the overall INS/GPS system, where data processing is performed in a single filter. This approach is similar to the loosely coupled one and differs mostly in terms of its diverse measurement model: instead of positions and velocities, pseudoranges calculated by the INS and measured by a GPS receiver are fed to the filter as observables. The basic procedures in the tight integration method can be described through the following steps [3]

1. Processing of the raw INS measurements, $(\Delta\theta_{ib}^b, \Delta V^b)$ through the mechanization equations in order to determine the position and velocity from INS, (r_{INS}^n, V_{INS}^n)
2. Use the raw GPS ephemeris information and the position and velocity from (1) to predict pseudoranges and Doppler measurement, $(\phi_{INS}, \dot{\phi}_{INS})$
3. Use of the predicted pseudorange and Doppler measurements from (2) as input to an INS/GPS Kalman filter. The filter takes the difference between the pseudorange and Doppler measurements from (2) and the raw GPS pseudorange and Doppler measurements, $(\phi_{GPS}, \dot{\phi}_{GPS})$ in order to determine the error estimates

of the position and velocity, $(\delta r^n \ \delta v^n)$ plus misalignment error, (ϵ^n) .

4. Use the error estimates from (3) to update the position and velocity from (1) in order to get a full state vector, $(r^n \ v^n \ R_b^n)$.

Clearly, tightly coupled integration is more forgiving for GPS data gaps (it permits the use of as few as one GPS pseudorange measurement in the estimation algorithm). However, the common filter in tight integration is more cumbersome than in the loosely coupled case due to a complex measurement model; the design matrix defines the relationship between pseudoranges and geodetic coordinates and the measurement noise in this case is colored noise that must be introduced to the system model as an additional component. Moreover, the degree of the observability of the state vector is generally weaker than in the loosely coupled strategy due to the large dimension of the state vector as well as indirect measurements. This degree of observability, in turn, defines the longer convergence period for error estimates as compared to the loosely-coupled case; furthermore, it can result in accuracy degradation of INS error estimation during this interval. For HS applications, due to error-corrupted GPS measurements, the additional challenge lies in separation of GPS and INS errors.

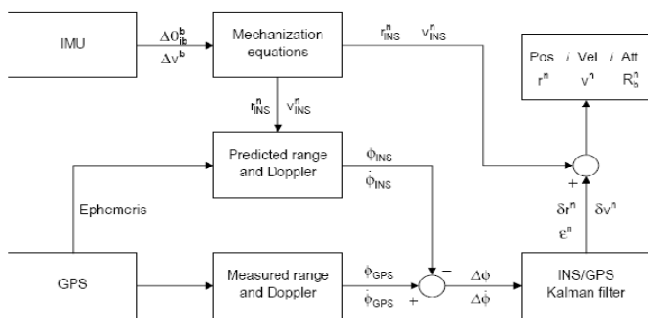

Fig. 2 Tightly Coupled Integration

TABLE I
 A BRIEF COMPARISON OF LC VS TC ARCHITECTURES

Implementation	Advantages	Disadvantages
Loosely coupled	<ul style="list-style-type: none"> • INS and GPS Kalman are implemented separately • The size of individual Kalman filter is small • Flexible, modular combination • Suitable for parallel processing, reliability 	<ul style="list-style-type: none"> • Sub-optimal performance • Four satellite required for a stable solution • INS data is not used for ambiguity estimation
Tightly coupled	<ul style="list-style-type: none"> • Less computation complexity • One error state model • Optimal solution, accuracy • GPS measurements can be used with less than 4 satellites • Faster ambiguity estimation 	<ul style="list-style-type: none"> • Large size of error state model • More complex processing

III. SIMULATION RESULTS

A. Stand Alone INS

A MATLAB code is developed to test and evaluate the navigation algorithm based on INS only. In order to validate the INS algorithm the following steps are carried out:

1. Generation of the reference trajectory.
2. Carry out the INS simulation in error-free case (i.e. no sensor or initialization errors), in order to obtain the derived INS trajectory.
3. Initial velocity error, accelerometer bias, gyro drift and initial tilt error were taken as case study and their effects on the derived INS trajectory are illustrated.

In order to evaluate the INS algorithm, a reference trajectory was generated. A GPSoft toolbox under MATLAB environment is used to generate this reference trajectory which is fully described in various textbooks and in particular in Aircraft control and simulation [5]. The suggested reference trajectory consists of five segments. This reference trajectory has been adopted in all simulation results for analysis and comparison studies. These segments are defined as follows:

1. Straight and leveled segment heading east.
2. Right turn segment.
3. Straight and leveled segment heading (- north).
4. Right turn segment.
5. Straight and leveled segment heading (- east).

The previous illustrated segments are set in a program. The simulation results are recorded and plotted in Figs. 3 and 4. Fig. 3 shows the reference trajectory in the local level frame while Fig. 4 presents this reference trajectory in the earth frame. The associated velocity components and Euler's angles are illustrated in Figs. 6 and 7 respectively.

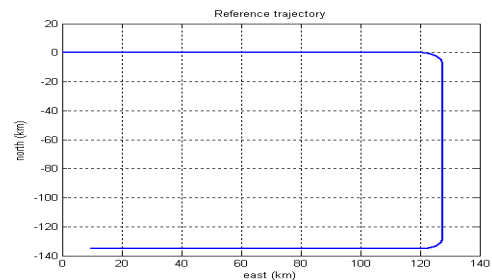

Fig. 3 Reference trajectory in the local Level frame

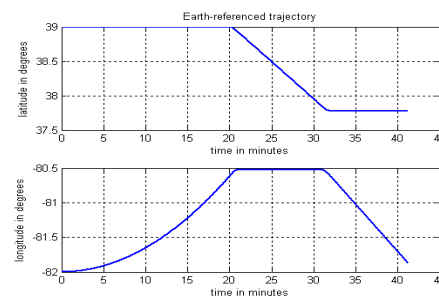

Fig. 4 Reference trajectory in the earth frame

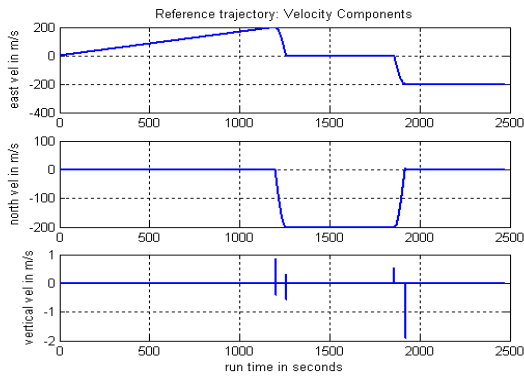

Fig.5 Velocities components of the reference trajectory

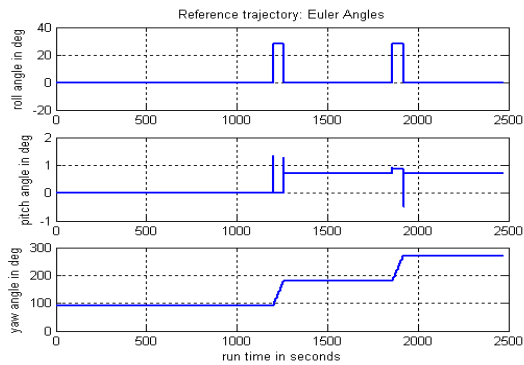

Fig. 6 Euler angles of the reference trajectory

B. Error Analysis

The reference trajectory created earlier is applied as an input for the proposed INS algorithm. Simulation runs have been conducted to discuss the effect of various types of errors that may degrade the performance of navigation system. Two main types of errors are discussed in this section, the navigation algorithm error and the sensors errors. First an INS simulation is demonstrated without sensor errors. The INS derived trajectory matches up quite closely with the truth generated one as shown in Fig. 6. The differences should be due only to imperfect generation of the simulated measurements (δV 's and $\delta \theta$) and imperfect position/velocity/attitude updating algorithm (primarily imperfect numerical integration).

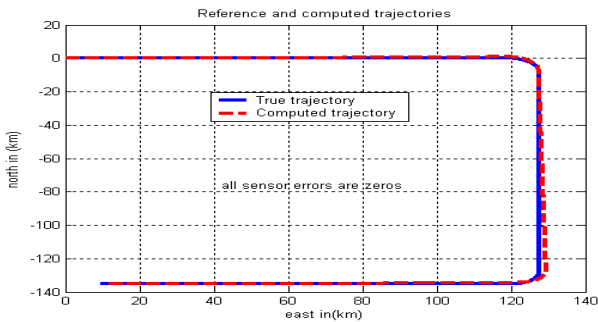

Fig. 7 Reference and INS derived trajectories without sensor errors

Second, when sensor's errors are included, in this work the effects of the various errors (initial velocity, initial tilt, accelerometer bias and gyro bias) have been studied. Table II gives the values of the mentioned errors adopted in the simulation. These have been chosen as case study for the effect of the errors on the INS derived trajectory.

TABLE II
 THE VALUES OF THE ERROR

The Errors	Low	Medium	High
Initial velocity error (m/s)	0.1	0.3	0.5
Initial tilt error (deg)	0.1	0.2	0.5
Accelerometer bias (μg)	50	75	100
Gyro bias (deg/hr)	0.015	0.055	0.15

1) The Initial Velocity Error Effect:

For 0.1 m/s north and east (x, y) velocity error, The RMS error in the horizontal position equal to 19.865m. However, when the velocity error is increased to 0.5 m/s, the RMS error in the horizontal position increased to 99.3269 m as illustrated in Fig. 8.

Verifying the strong coupling between the east velocity error and the roll error, the max roll error for the INS derived trajectory is increased from 0.001deg. to 0.005 deg., when the east velocity error is increased from 0.1 to 0.5 m/s. Also due to the strong coupling between the north velocity error and the pitch error, the max pitch error for the INS derived trajectory is increased from 0.75×10^{-3} deg. to 0.004 deg. when the north velocity error is increased from 0.1 to 0.5 m/s. In addition, the yaw errors with 3×10^{-3} degree peak error are shown in Figs. 9 and 10.

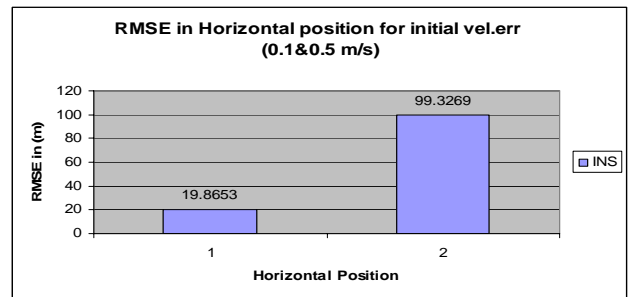

Fig. 8 RMSE in horizontal position for 0.1 and 0.5 m/s δv

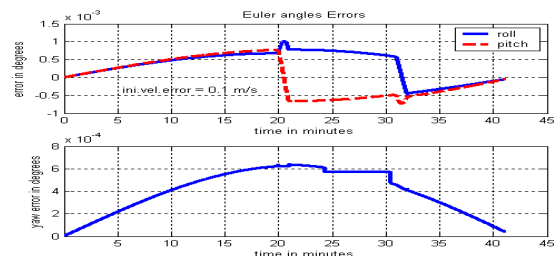

Fig. 9 Euler angles errors for 0.1 m/s δv

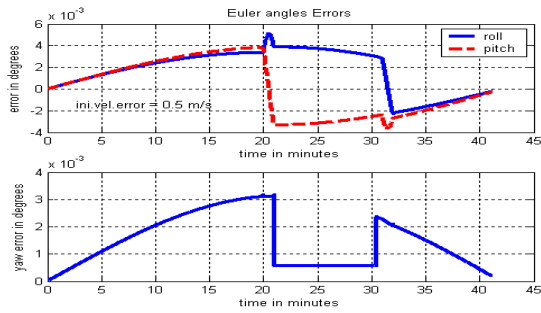

Fig. 10 Euler angles errors for 0.5 m/s δv

2) The Accelerometer Bias Effect

In order to study the effect of the accelerometer bias on the derived INS trajectory, two values have been adopted. The adopted values are $50\mu g$ and $100\mu g$ which represented the navigation and the tactical grade respectively. First, $50\mu g$ is set into the program. Fig. 11 shows the RMSE in horizontal position. It is clear that this difference is due to the improper measurement of the accelerometer which in turn, results in improper computation in velocity and position. Second, $100\mu g$ accelerometer bias is adopted. As one would expect, the RMSE in horizontal position, will increase. This is clear in Fig. 11, where the values are list below these figures.

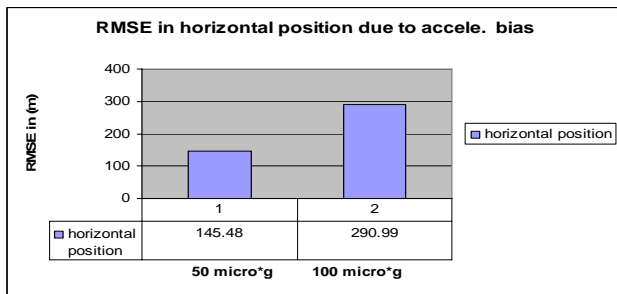

Fig. 11 RMSE in horizontal position due to accelerometer bias

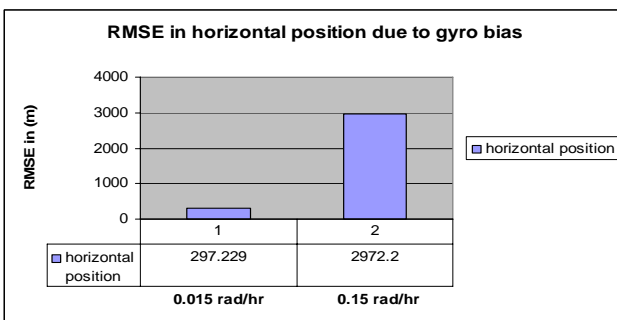

Fig. 12 RMSE in horizontal position due to gyro drift

3) The Gyro Drifts Effect:

Two values of bias have been selected; these values are 0.015 rad/hr and 0.15rad/hr which represented the navigation and the tactical grade respectively. Due to this drift which in turn results in improper projection of the accelerometer measurement into the reference frame, a deviation between the two trajectories has been occurred. This

deviation is illustrated in Fig. 12 as 297.229m RMSE in the horizontal position. Clearly when the gyro drift is increased to 0.15 rad/hr the deviation between the two trajectories as well as the RMSE in the horizontal velocity, are increased.

4) The Tilt Error Effect:

Also two values 0.1deg and 0.5 deg as initial tilt error are set to the program. Fig. 13 shows the difference between the two trajectories with tilt error equal to 0.1deg. Obviously, the derived INS trajectory is deviated too much from the reference trajectory. This is also shown in Fig. 14 as 6663m RMSE in the horizontal position. The reason is that, since the horizontal plane is unlevelled, the east and north accelerometer will read a component of the gravity from the beginning instead of reading zero component if the horizontal plane is leveled. Then these components will results in error which accumulated with time. As shown in Fig. 13 increasing this tilt error to be 0.5deg, the results get worst.

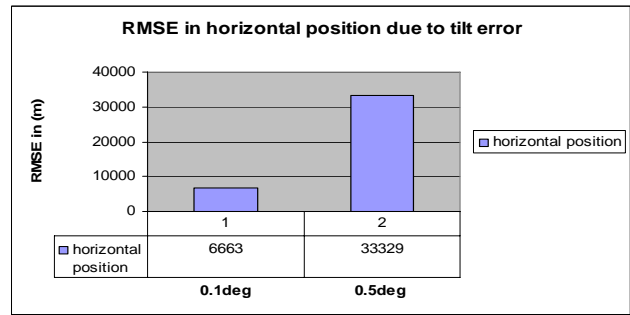

Fig. 13 RMSE in horizontal position due to tilt error

It is clear that the tilt error has significant effect on the INS derived trajectory. This is why the INS should be initially aligned to the navigation frame.

5) The Effect of the All Errors:

Extensive simulation has been carried out for each individual error. After the effects of the individual error have been studied, the effects of the all errors together have been conducted. The RMS error in the horizontal position for all cases (i.e. minimum, intermediate and maximum), is shown in Fig. 14. It is obvious from this figure that the RMS error increased as the sensor and initialization errors are increased. The RMS error in the east and north velocities for the other cases are shown in Fig. 15. The error is increased due to the increasing in the sensor errors.

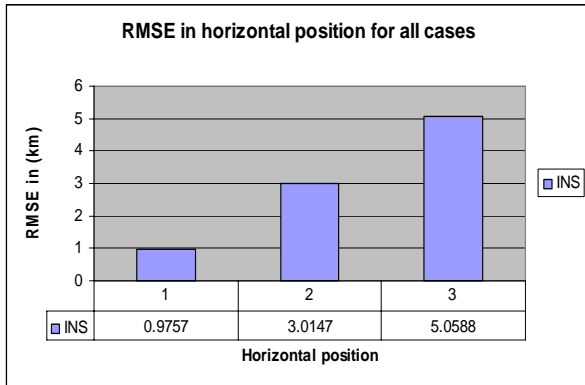

Fig. 14 RMSE in horizontal position for all cases

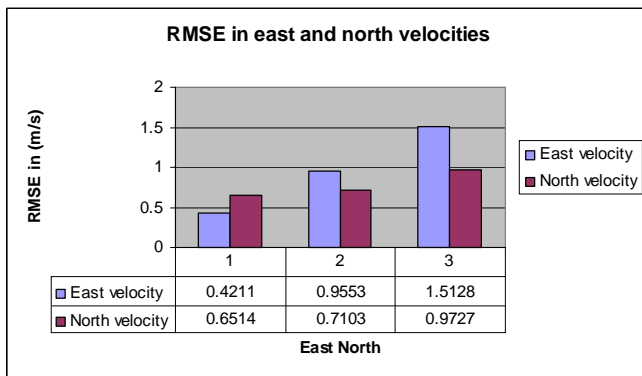

Fig. 15 RMSE in the latitude and longitude for all cases

The RMS error values, which are obtained, are relatively high. Thus, it becomes necessary to augment the INS with external device such as GPS in order to enhance its performance. This is has been done in the following sections. In other words, error analysis results in searching for alternatives to reduce their effects and consequently enhance the performance of the navigation system.

IV. GPS ONLY SOLUTION

In order to obtain the simulated GPS trajectory, the same reference trajectory, which was used in previous section, is adopted here to specify the user position. Then, a GPS receiver is simulated using MATLAB environment and GPSToolbox. The true position and the GPS estimated position are shown in Fig. 16 Obviously, the two trajectories are very similar and the difference between them is illustrated in Fig. 17. As it is widely known that satellite based navigation systems perform worse for vertical positioning than for horizontal positioning, this is clear in Fig. 21 where the vertical position error reached 100 m while the horizontal position error in x and y (east and north) reached 18m.

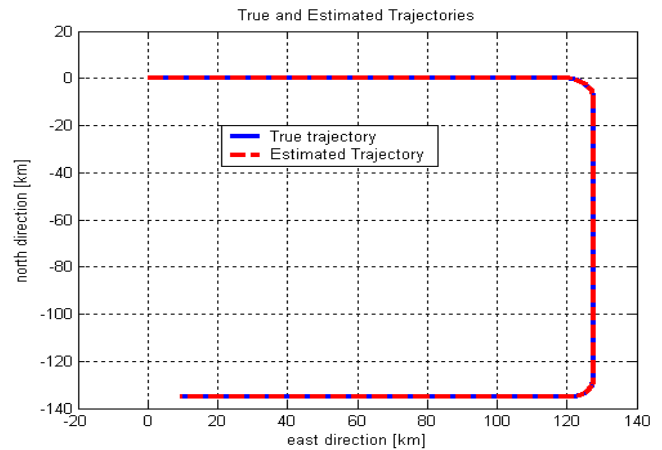

Fig. 16 True and simulated GPS trajectories

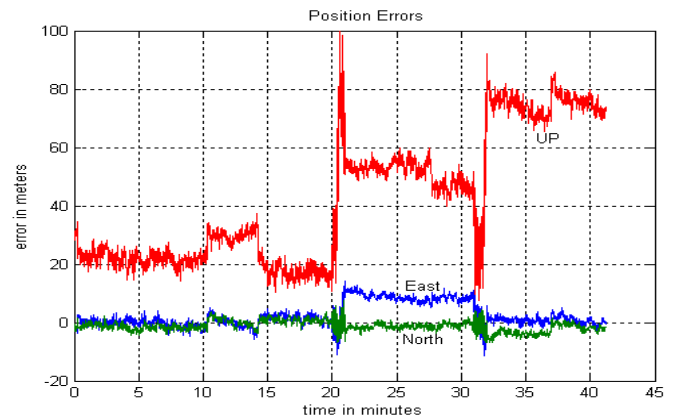

Fig. 17 Position error between the true and simulated GPS trajectories

V. INS/GPS INTEGRATION USING KALMAN FILTER

The detailed implementation of the Kalman filter can be found in [6]. An example of a 15 states Kalman filter is given as follows: The error states include three position parameters, three velocity parameters, three attitude parameters, three accelerometer bias parameters and three gyro drift parameters.

$$X = [\delta\phi \ \delta\lambda \ \delta h \ \delta v_E \ \delta v_N \ \delta v_U \ \delta\varphi \ \delta\theta \ \delta\psi \ \delta x \ \delta y \ \delta z \ \delta a_x \ \delta a_y \ \delta a_z] \quad (1)$$

The state transition matrix $F_{k,k-1}$ can be obtained using the dynamics matrix, F, as follows:

$$F_{k,k-1} = \exp(F\Delta t) \approx I + F\Delta t \quad (2)$$

The measurement equation that uses GPS velocity and position as measurements update is given as follows [6]:

$$z_k = \begin{bmatrix} r_{INS}^j - r_{GPS}^j \\ v_{INS}^j - v_{GPS}^j \end{bmatrix} = \begin{bmatrix} \varphi_{INS} - \varphi_{GPS} \\ \lambda_{INS} - \lambda_{GPS} \\ h_{INS} - h_{GPS} \\ v_{INS}^j - v_{GPS}^j \end{bmatrix}, H_k = \begin{bmatrix} I_{3 \times 3} & 0_{3 \times 3} & 0_{3 \times 3} & 0_{3 \times 3} & 0_{3 \times 3} \\ 0_{3 \times 3} & I_{3 \times 3} & 0_{3 \times 3} & 0_{3 \times 3} & 0_{3 \times 3} \end{bmatrix} \quad (3)$$

The measurement equation that uses zero velocity update (ZUPT) as measurements is given as follows [6]:

$$z_k = [V_{INS}^T - 0] = \begin{bmatrix} V_E - 0 \\ V_N - 0 \\ V_U - 0 \end{bmatrix}, H_k = \begin{bmatrix} 0_{3 \times 3} & I_{3 \times 3} & 0_{3 \times 3} & 0_{3 \times 3} & 0_{3 \times 3} \end{bmatrix} \quad (4)$$

A. Loosely Coupled Results

In this case the same dynamic vehicle trajectory and the same INS simulation are used. A Kalman filter with 18 states is used. These states are:

- 3-position errors.
- 3-velocity errors.
- 3-attitude errors
- 3-gyro biases.
- 3-accelerometer biases.
- 3- Bias in GPS estimated position.

The Kalman observables are the east and north position differences between the INS and the external aiding source GPS for the same trajectory which contained the errors, the difference between the reference and the derived aided trajectories is illustrated in Fig. 18 as a horizontal position. Fig. 19 shows the error in the east and north velocity components in both aided and unaided trajectories. It is clear that the results are improved when a Kalman filter is used. It is clear from this figure that the error of east and north velocities is improved compared with the stand-alone INS. It should be noted that the over shoots which appeared in the curves due to the transient as the Kalman filter is converging. The Euler angles for both aided and unaided trajectories can be shown in Fig. 20. Also the filter does well in this simulation. It should be noted that the over shoots which appeared in the curves due to the transient as the Kalman filter is converging.

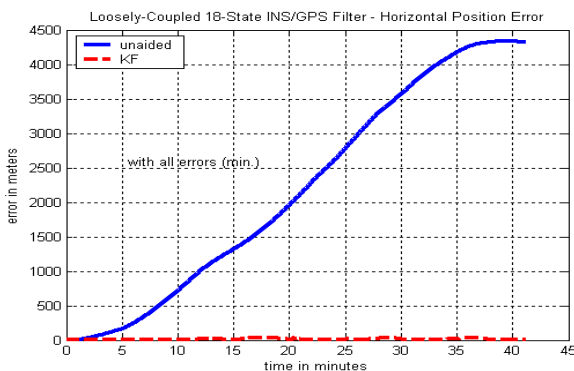

Fig. 18 Horizontal position error in INS and aided trajectories (LC)

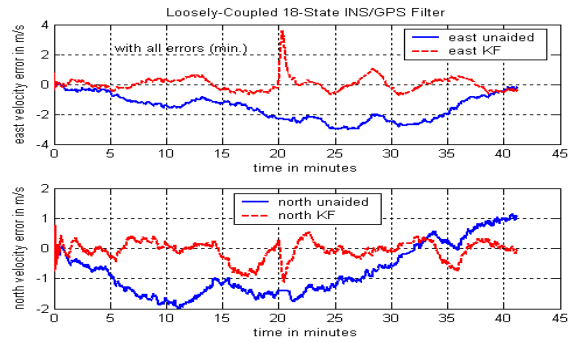

Fig. 19 Velocity components in INS and INS/GPS trajectories (LC)

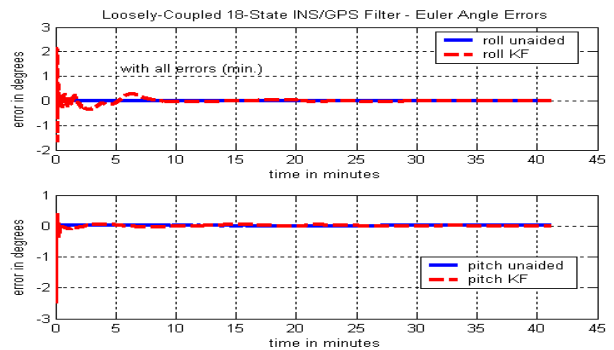

Fig. 20 Euler angles in INS and INS/GPS trajectories (loosely coupled)

Fig. 21 illustrates the RMS error comparison between the loosely aided and unaided trajectories for the all cases (minimum, intermediate and maximum errors). Fig. 21 shows the RMS error in the horizontal position. It is clear from this figure that the results are improved when Kalman filter is used.

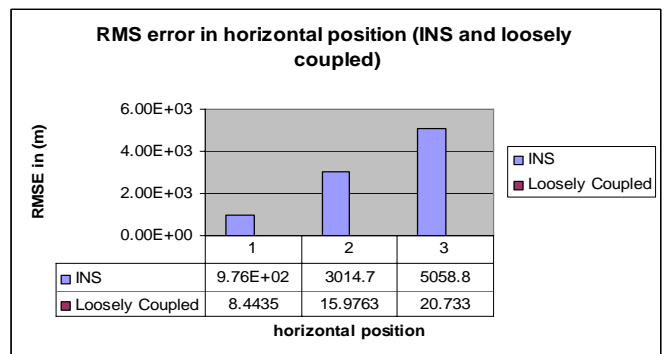

Fig. 21 RMSE in the horizontal position for INS and loosely coupled trajectories

B. Tightly Coupled Results

In this architecture, as mentioned before, the filter is able to access the raw, unprocessed, aiding data. This helps ensure the independence of the data and allows the filter to be constructed such that it can still extract some aiding information even if there are less than 4 satellites in view.

The filter differs from the 18-state loosely coupled approach in that the three position biases states are replaced by two

receiver clock bias states (bias and drift) and twelve pseudo range bias states.

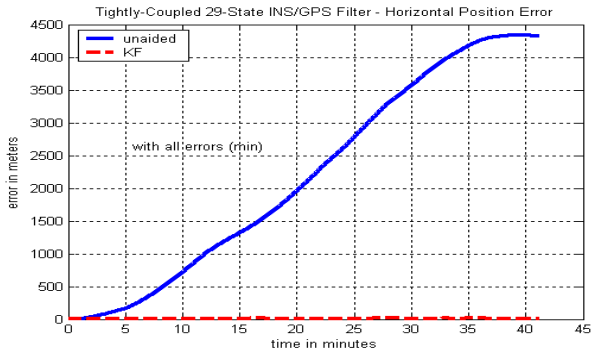

Fig. 22 Horizontal position error in INS and aided trajectories (TC)

The difference between the two trajectories is illustrated as a horizontal position error. Fig. 22 shows the horizontal position error in both aided and unaided trajectory. The errors in Euler angles, can be shown in Fig. 23. The tightly coupled approach proves its value, however, when the satellite coverage is degraded. This can be shown in Fig. 24 when the number of satellites are decreased from 6 down to 3 (2 minutes) and then 1 (also 2 minutes) and finally to 0. As the results, shows, the filter does quite well even when there are less than 4 satellites in view. In this case, although there is complete GPS data outage, the RMS error in horizontal position is 269.02m which is significantly decreased compared with stand-alone INS (975.7888 m).

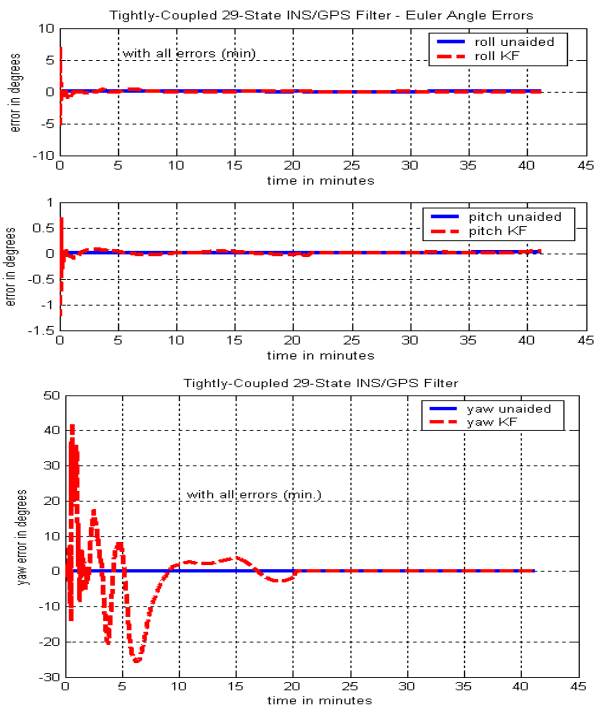

Fig. 23 Euler angles in INS and INS/GPS trajectories (TC)

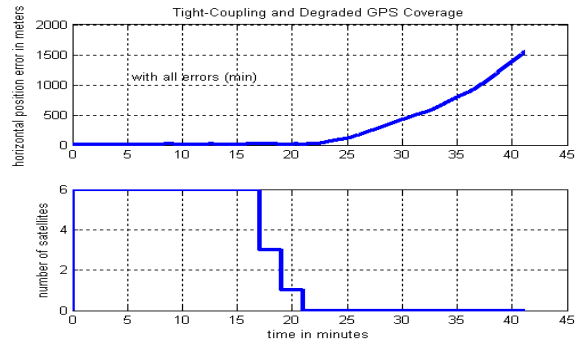

Fig. 24 TC and degraded GPS coverage

C. Loosely vs Tightly Coupled Results

The following figures will illustrate the RMS error in longitude, east velocity, north velocity and horizontal position for INS, loosely coupled and tightly coupled integration for all cases (minimum, intermediate and maximum errors). Fig. 25 shows the RMS error in longitude. The values of the loosely and tightly are too small so, they are not appear in the figure but they are listed below. It is clear that from this figure the tightly coupled integration has the best performance.

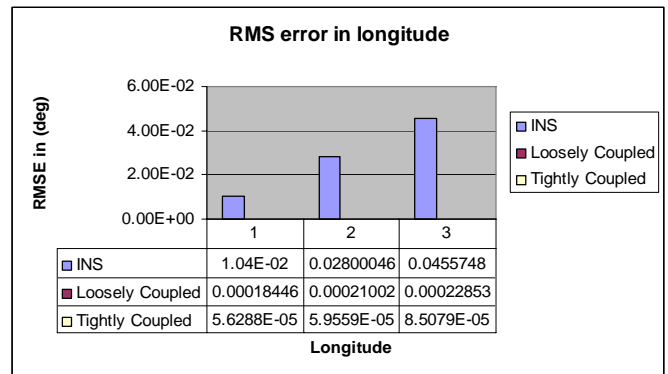

Fig. 25 RMSE in longitude for INS, LC and TC

The RMSE in east and north velocity are shown in Figs. 26 and 27 respectively. The loosely coupled performs slightly better than the tightly coupled. The RMSE in the horizontal position is illustrated in Fig. 28 the tightly coupled results are the best.

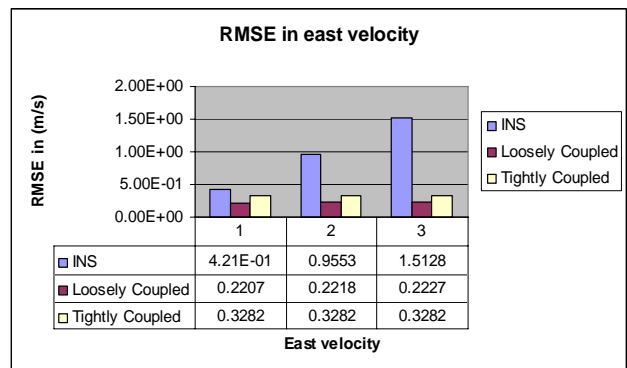

Fig. 26 RMSE in east velocity for INS, LC and TC

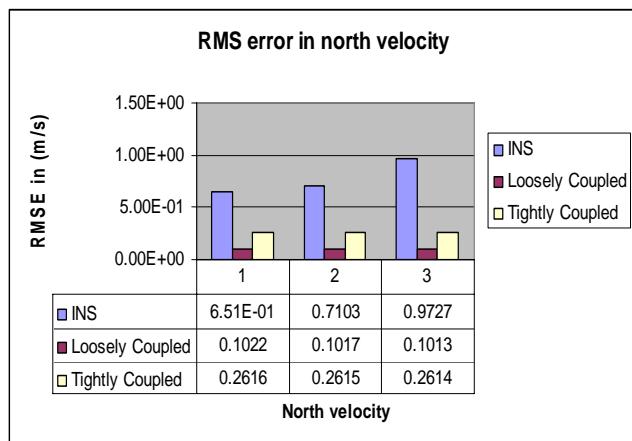

Fig. 27 RMSE in north velocity for INS, LC and TC

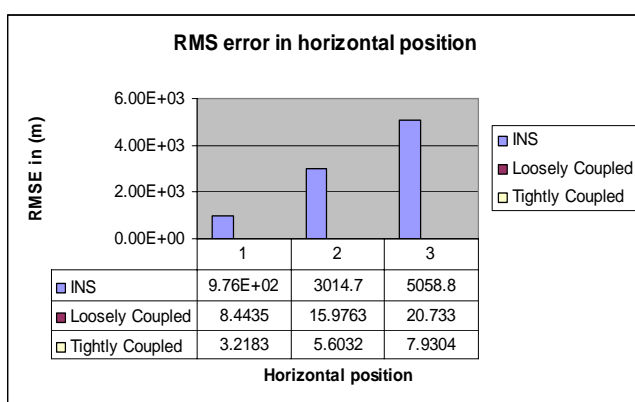

Fig. 28 RMSE in horizontal position for INS, LC and TC

VI. CONCLUSION

Under good conditions GPS will be able to provide continuous and accurate positioning to the user at all time. But unfortunately good conditions will not always occur as the signal from the satellites can be blocked or attenuated by different error sources. The idea is that as INS solutions tend to drift with time, it will be updated as often as possible with measurements from the GPS. The aim of this paper is attempted to show the advantages of INS/GPS integrated navigation system, the INS/GPS integrated system provided a level of position accuracy which is directly associated to the GPS-only solution in a situation of good satellite geometry and no GPS outages. The loosely coupled integrations provide good accuracy under full satellite visibility. Under such conditions, a loosely coupled integration strategy is preferred due to its easier implementation and lower computational load. Even during poor satellite coverage (less than four satellites), using tightly coupled integration the updating of the INS can still be performed. This is due to the use of predicted and raw pseudo range and Doppler measurements.

REFERENCES

[1] Titterton D.H. and Weston, J.L. (1997): "Strapdown inertial navigation technology," Peter Peregrinus Ltd., London, UK, 1997.

[2] El-Rabbany, A., "Introduction to GPS: the global positioning system". (Artech House mobile communications series). © 2002 ARTECH HOUSE, INC. 685 Canton Street Norwood, MA 02062.
 [3] Mohander, S.G., Lawrance, R.W., Angus, P.A. *Global positioning system inertial navigation system and integration*, JohnWiley & Sons, 2001.
 [4] El-Sheimy." *Inertial techniques and INS/DGPS Integration*". *ENGO 623- Lecture Notes*, the University of Calgary, Department of Geomatics Engineering, Calgary (2004).
 [5] B. L. Stevens and F. L. Lewis. *Aircraft Control and Simulation*. John Wiley & Sons, Inc., 1992.
 [6] Greg Welch, "An Introduction to the Kalman Filter" Gary Bishop University of North Carolina at Chapel Hill Department of Computer Science Chapel Hill, NC 27599-3175 (2001).