

Comparative Study of Scheduling Algorithms for LTE Networks

Samia Dardouri, Ridha Bouallegue

Abstract—Scheduling is the process of dynamically allocating physical resources to User Equipment (UE) based on scheduling algorithms implemented at the LTE base station. Various algorithms have been proposed by network researchers as the implementation of scheduling algorithm which represents an open issue in Long Term Evolution (LTE) standard. This paper makes an attempt to study and compare the performance of PF, MLWDF and EXP/PF scheduling algorithms. The evaluation is considered for a single cell with interference scenario for different flows such as Best effort, Video and VoIP in a pedestrian and vehicular environment using the LTE-Sim network simulator. The comparative study is conducted in terms of system throughput, fairness index, delay, packet loss ratio (PLR) and total cell spectral efficiency.

Keywords—LTE, Multimedia flows, Scheduling algorithms.

I. INTRODUCTION

THE Third Generation Partnership Program (3GPP) members started a feasibility study on the enhancement of the Universal Terrestrial Radio Access (UTRA), in the aim of continuing the long time frame competitiveness of the 3G Universal Mobile Telecommunications System (UMTS) technology beyond High Speed Packet Access (HSPA). This project is called Long Term Evolution (LTE) [1].

Long Term Evolution (LTE) is the next step forward in cellular 3G services. Expected in the 2008 time frame, LTE is a 3GPP standard that provides for an uplink speed of up to 50 megabits per second (Mbps) and a downlink speed of up to 100 Mbps. LTE will bring many technical benefits to cellular networks. Bandwidth will be scalable from 1.25 MHz to 20 MHz. This will suit the needs of different network operators that have different bandwidth allocations, and also allow operators to provide different services based on spectrum.

LTE has been set aggressive performance requirements that rely on physical layer technologies, such as, Orthogonal Frequency Division Multiplexing (OFDM) and Multiple-Input Multiple-Output (MIMO) systems, Smart Antennas to achieve these targets [2]. The main objectives of LTE are to minimize the system and User Equipment (UE) complexities, allow flexible spectrum deployment in existing or new frequency spectrum and to enable co-existence with other 3GPP Radio Access Technologies (RATs). Efficiency in 3G networks allow carriers to provide more data and voice services over a given bandwidth. Orthogonal Frequency Division

Multiplexing (OFDM) has been applied in the physical layer of 3GPP LTE downlink system thanks to its high data rate transmission and high bandwidth efficiency to mitigate the inter symbol interference (ISI) in a severe multi-path fading channel [1]. In wideband mobile channels, the pilot-based signal correction scheme has been proven a feasible method for OFDM systems. Although the LTE specs describe both Frequency Division Duplexing (FDD) and Time Division Duplexing (TDD) to separate Uplink and Downlink traffic, market preferences dictate that the majority of deployed systems will be FDD [3].

Scheduling is also an extremely important factor and it's a key Radio Resource Management (RRM) mechanism for realizing Quality of Service (QoS) requirements and optimizing system performance of LTE network. As specified, the radio network will be optimized for higher performance [4], [5].

In order to be able to meet the QoS demands for different services, many packet-scheduling algorithms have been developed to allocate limited frequency and time resources efficiently and fairly to real-time and non-real-time traffic for all data transfer devices including mobile and wireless networks. Examples of such scheduling algorithms include Proportional Fairness (PF), Exponential Proportional Fairness (EXP-PF), and Modified Largest Weight Delay First (MLWDF) [6]. In this paper, we aim to evaluate the performance of several scheduling algorithms for VoIP and Video applications in terms Throughput, Delay, PLR and Cell spectral efficiency in different scenarios. The simulation results were generated using the open source LTE system simulator called long term evolution-SIM (LTE-SIM) [7].

The rest of the paper is organized as follows. Section II outlines the characteristics of the overall system description architecture and it describes LTE-Sim network simulator. Section III introduces the background, motivations and basic principles scheduling algorithms in LTE. Section IV discusses the simulation parameters and defines the performance evaluation scenario for different flows for different scheduling strategies in LTE, as well as, it explains the simulation results. Finally, Section V represents the conclusion of this paper.

II. THE LTE MODULE FOR LTE-SIM

LTE utilizes the Resource Block (RB) concept, characterized as being a block of subcarriers with a number of consecutive subcarriers in the frequency domain and a number of consecutive OFDM symbols in the time domain (12 consecutive subcarriers by 7OFDM symbols), as shown in Fig. 1. In FDD operation mode, a frame of 10ms is divided

S. Dardouri is with National Engineering School of Tunis, Tunisia and InnoV'COM Lab/Sup'Com, University of Carthage, Tunisia (e-mail: samia_telecom@yahoo.fr).

R. Bouallegue was with InnoV'COM Lab/Sup'Com, University of Carthage, Tunisia (e-mail: ridha.bouallegue@ieee.org).

into 20 slots of 0.5ms each. Each two slots constitute a 1ms sub-frame. Each sub-frame represents a Transmission Time Interval (TTI) which is the minimum transmission unit. The physical layer interface is a transport block, or a group of RBs, with a common Modulation and Coding Scheme (MCS). Each TTI contains at most one transport block per User Equipment (UE) [8].

A resource block is a resource allocation unit where a pair of resource block is the minimum allocation unit used by the scheduler while determining the allocations on a frame. In frequency domain, one resource block is a formation of 12 subcarriers length. The resource block size is the same for all bandwidths.

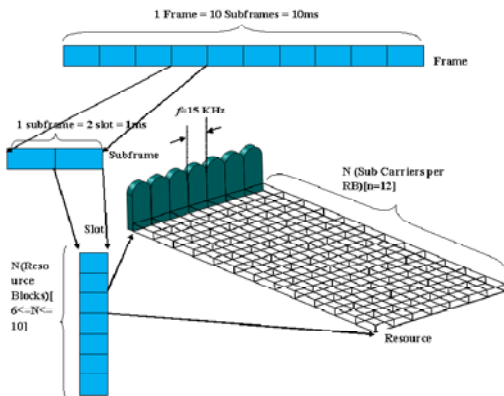

Fig. 1 The structure and allocation of the eNodeB transmission resources symbols

The LTE-SIM simulator models different uplink and downlink scheduling strategies in multicell/multiuser environments, it takes into account user mobility, radio resource optimization, frequency reuse techniques, the adaptive modulation, and coding (AMC) module. It also includes other aspects that are relevant to the industrial and scientific communities, two types of mobility models were developed, known as: random direction and random walk [8]. The user speed was selected between 0, 3, 30, 120 km/h, which were corresponding to static, pedestrian, and vehicular scenarios respectively.

III. SCHEDULING ALGORITHMS IN LTE

Fig. 2 shows an overview of the user-plane and control-plane protocol stack at the eNodeB, as well as the corresponding mapping of the primary RRM related algorithms to the different layers. The family of RRM algorithms at the eNodeB exploits various functionalities from Layer 1 to Layer 3. Data is transferred between the MAC sublayers in the UE and eNodeB using transport blocks which are sent via the downlink and uplink shared transport channels (DL-SCH and UL-SCH).

The Channel Quality Indicator (CQI) manager at Layer 1 processes the received CQI reports (downlink) and Sounding Reference Signals (SRSs) (uplink) from active users in the cell. Each received CQI report and SRS is used by the eNodeB for scheduling decisions [9], [10].

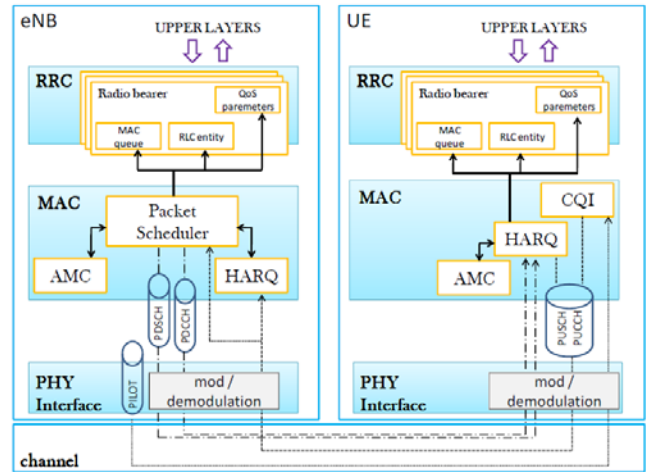

Legend
 AMC: Adaptive Modulation and Coding
 RLC: Radio Link Control
 PDCCH: Physical Downlink Control Channel
 PUSCH: Physical Uplink Shared Channel
 CQI: Channel Quality Indicator
 HARQ: Hybrid Automatic Repeat Request
 RRC: Radio Resource Control
 PD-SCH: Physical Downlink Shared Channel
 PUCCH: Physical Uplink Control Channel

Fig. 2 Interaction of the main RRM features [14]

The MAC sublayer scheduler runs the scheduling algorithms which determine what gets sent when and to/by whom. The eNB's MAC scheduler receives inputs from various sources which guide the scheduling algorithms. Within the scheduler, all the queues are mapped into multiple groups depending on the traffic classifications. The scheduler moves to the subsequent group when the previous group is served and there are various levels of priorities within these groups and the scheduler returns the recommended number of bits to the frame generator which in turn defines the allocation block or the resource block and also provides feedback to the scheduler in terms of number of bits and blocks used by the sub-frames.

A simplified model of packet scheduling in the downlink LTE system is shown in Fig. 3.

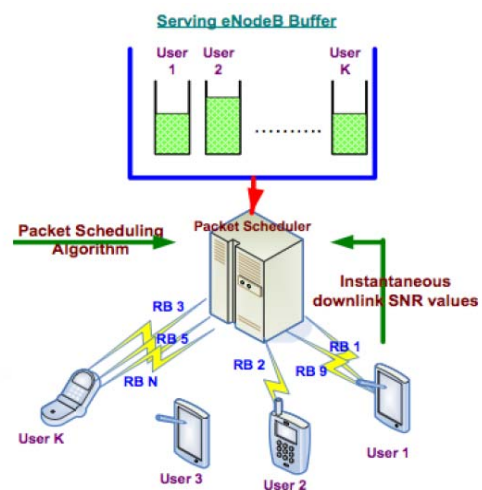

Fig. 3 Packet Scheduling Model in the Downlink of the 3GPP LTE System

The whole process can be divided into a sequence of the scheduler which calculates a metric for each stream that can be allocated. We assume that the metric assigned to stream i on j -th sub-channel is defined by $w_{i,j}$, to obtain metric, schedulers we usually need to know the average transmission rate \bar{R}_i of flow i , and the flow rate available to the EU on the j -th sub-channel.

This approach is important when the metric takes into account the anterior performance of sequenced flow to balance the distribution of resources between UEs. In particular, at each TTI, the estimate \bar{R}_i is given by:

$$\bar{R}_i(k) = 0.8 \bar{R}_i(k-1) + 0.2 R_i(k) \quad (1)$$

where $R_i(k)$ is the rate allocated to i -th flow during the k -th TTI and $\bar{R}_i(k-1)$ is the average transmission data rate estimating at the $(k-1)$ -th TTI.

In the following, the description of three different scheduling algorithms were used in all simulation scenarios, these are: PF as well as EXP-PF and MLWDF.

A. Proportional Fair (PF)

The PF scheduling algorithm provides a good tradeoff between system throughput and fairness by selecting the user with highest instantaneous data rate relative to its average data rate.

For this algorithm, the metric is defined as the ratio between the instantaneous flow available for i -th flow and the medium flow calculated at the moment $(k-1)$ [11], [12].

$$w_{i,j} = \frac{r_{i,j}}{\bar{R}_i} \quad (2)$$

where $r_{i,j}$ is calculated by the AMC module considering the value of the CQI on the j -th sub-channel is sent by the UE who is intended for i -th flow.

B. Modified Largest Weighted Delay First (M-LWDF)

M-LWDF is a type of algorithm designed for the purpose of supporting multiple real-time data users in CDMA-HDR systems [13]. This scheduler supports user being able to ask for multiple services with different requirements in QoS. For each flow real time, by considering the maximum timer t_i , the probability is defined as the maximum probability δ_i that the time of the first package of the queue exceeds the fixed maximum time $D_{HOL,i}$ [14].

The network simulator LTE-Sim implements only FIFO (First In Out First) queues.

In order to give priority to real time flows having the highest time (time of the first package of the queue) and having the best conditions of propagation on the radio operator channel, the metric is defined in this scheduler by:

$$w_{i,j} = \alpha_i D_{HOL,i} \frac{r_{i,j}}{\bar{R}_i} \quad (3)$$

where $r_{i,j}$ and \bar{R}_i have the same signification in the previous equation, and α_i is given by:

$$\alpha_i = - \frac{\log \delta_i}{\tau_i} \quad (4)$$

C. Proportional Fairness (EXP/PF)

Exponential Proportional Fairness (EXP/PF) is a sort of algorithm, which configures the multimedia applications in a system of Adaptive Coding & Modulation/Time Division Multiplexing (ACM/TDM) system. This type of algorithm can have both the real-time service user as well as non-real-time service [15] and it can enhance the priority of real-time flow with respect to no-real-time flow [16].

For flows real time, the metric is calculated by using the following equations:

$$w_{i,j} = \exp\left(\frac{\alpha_i D_{HOL,i} - X}{1 + \sqrt{X}}\right) \frac{r_{i,j}}{\bar{R}_i} \quad (5)$$

where X is given by:

$$X = \frac{1}{N_{rt}} \sum_{i=1}^{N_{rt}} \alpha_i D_{HOL,i} \quad (6)$$

with N_{rt} is the number of active real time flows in downlink direction.

IV. SIMULATION AND PERFORMANCE

The performance of PF, M-LWDF, and EXP/PF algorithms is judged based on packets throughput, Packet Loss Ratio (PLR), packet latency (delay), fairness index and cell spectral efficiency. Fairness among users is implemented using Jain's method [17]. A single cell of 1 km with inter-cell interference is modeled; the cell itself has one eNodeB and a random number between 5 to 20 users (Fig.4). The UE moving cell is being elaborated adopting the random way-point model [18]. The speed of 3 and 120 km/h will be used, in order to test the pedestrian and vehicular scenarios. Simultaneously, a best effort, video and VoIP flow is allocated within each UE. The scenarios implemented via software are called LTE-Sim simulator [7].

The main simulation parameters used in LTE-Sim are summarized in Table I.

TABLE I
SIMULATION PARAMETERS

Simulation Parameters	Type	Values
Simulation Duration	Constant	100 Sec
Frame Structure	Constant	FDD
Cell Radius	Constant	1km
Bandwidth	Constant	5 MHz
Video bit-rate	Constant	242 kbps
VoIP bit-rate	Constant	8.4 kbps
Maximum Delay	Constant	0.6ms
User Speed	Variable	3, 120 km
UEs number	Variable	From 5 to 30

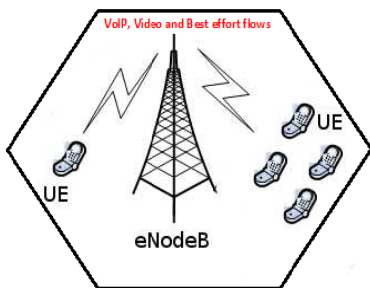

Fig. 4 LTE simulated scenario

The graphs are divided into three parts: the first concerns the best effort flows, the second, however, is consecrated to the video flows, and the last one focus on for the VoIP flows.

The delay for best effort flow is presented in Fig. 5. It can be noticed that the Delay is constant for EXP/PF and PF and M-LWDF. In general the delay is constants; its value is always 0.001 seconds for all scheduling algorithms.

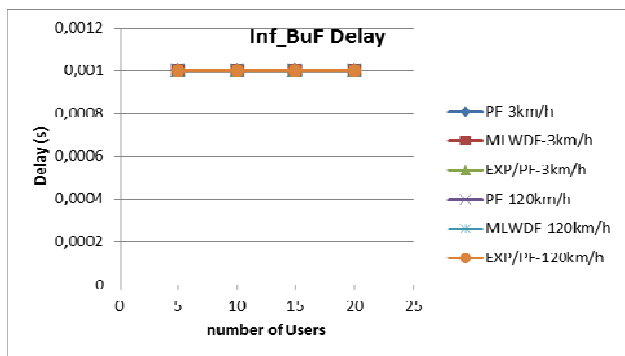

Fig. 5 Delay for best effort flows

The throughput performance for best effort flow is given in Fig. 6. It decreases as long as the number of users is increasing, and it rises when increasing the speed of users.

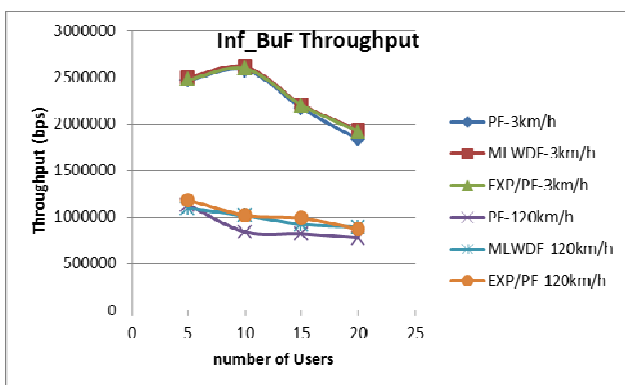

Fig. 6 Throughput for best effort flows

The packet loss ratio is given in Fig. 7. It is decreasing constantly as much as the number of users is increasing.

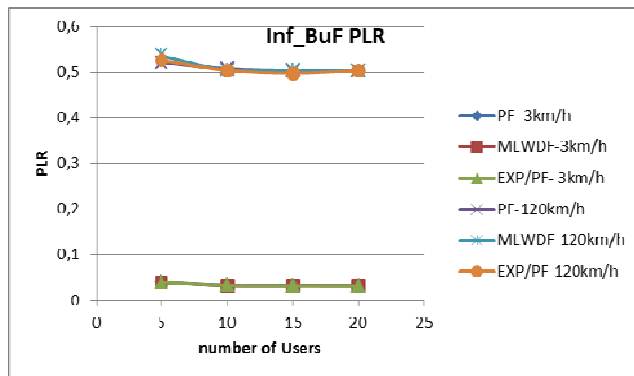

Fig. 7 Packet Loss Ratio for best effort flows

Fig. 8 shows that the fairness index for Best effort Flows is changing for all algorithms till the peak on of 15 users.

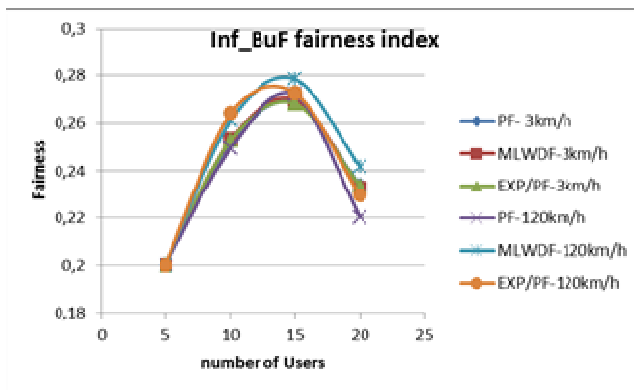

Fig. 8 Fairness for best effort flows

As can be seen in Fig. 9, the video delay is almost not increasing, despite the rise of the number of users for M-LWDF and EXP/PF Scheduling Algorithm. As opposed to PF scheduling algorithm which has a high video delay. It can be noticed that, in LTE, the fairness index is decreasing as much as the users are getting higher, especially for the proportional fair scheduling algorithm.

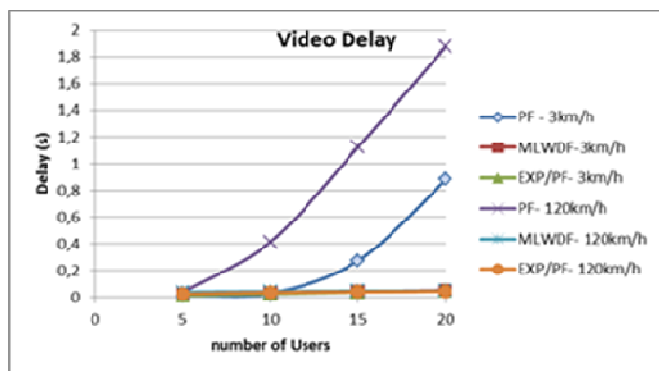

Fig. 9 Delay for video flows

The throughput of the video flows is given in Fig. 10. As the number of users increases, the throughput also increases for M-LWDF and EXP/PF scheduling algorithms. However

this is not the case for the proportional fair scheduling algorithms.

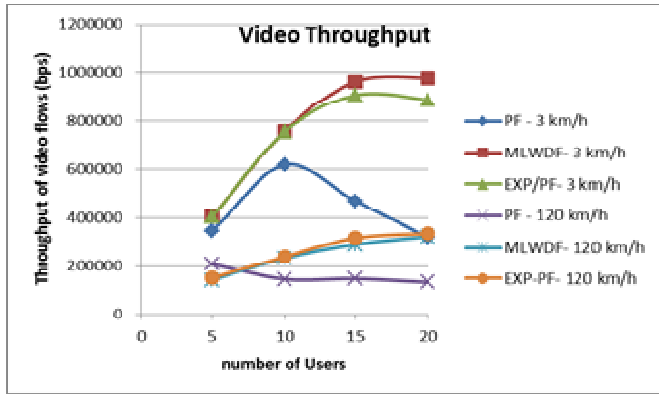

Fig. 10 Throughput for video flows

Fig. 11 shows that the packet loss ratio at video flows of PF Scheduling Algorithm is higher than other Scheduling Algorithm. Actually, losing the packets through the transmitting process is increasing as long as the video flows are transmitted.

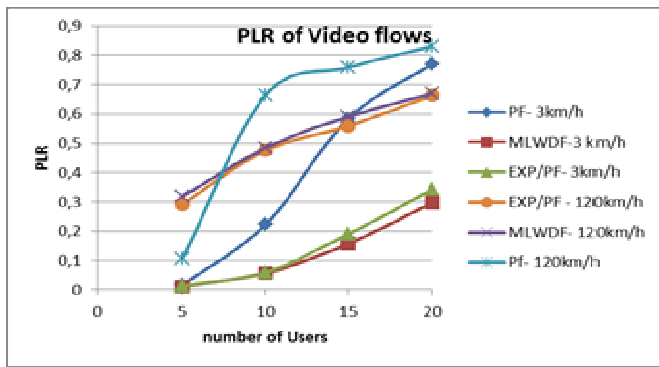

Fig. 11 Packet Loss Ratio for video flows

As it can be seen in Fig. 12, mobility of users had a significant impact on video traffic in all scheduling algorithms.

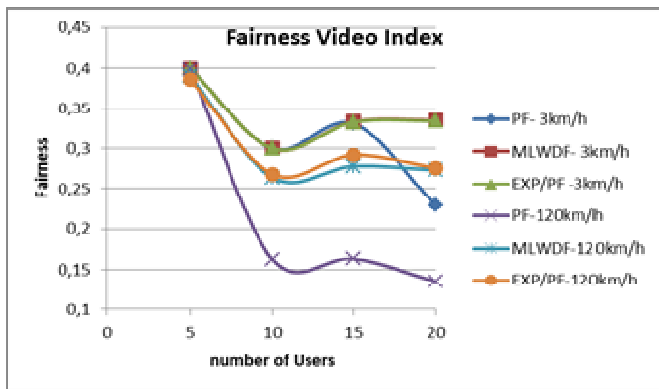

Fig.12 Fairness for video flows

We have also measured VoIP delay while gradually increasing the number of VoIP users. This is shown in Fig. 13. Similar to previous results, there is a long delay in all the algorithms across different speeds.

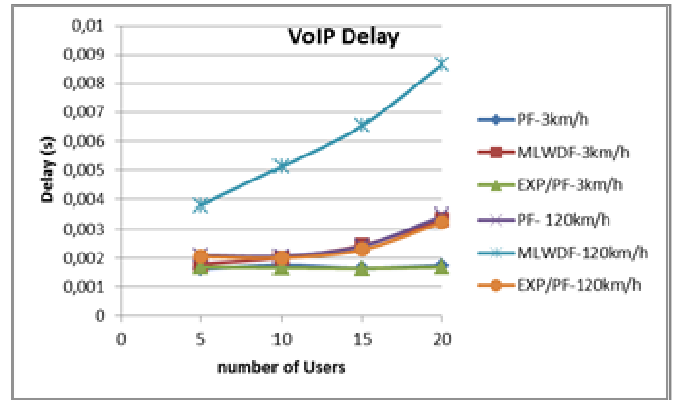

Fig. 13 Delay for voip flows

The throughput of the VoIP flows is given in Fig. 14. It can be noticed that the throughput is increasing with the rise of the number of VoIP users. There is an unchanging throughput in all algorithms when increasing mobility of users.

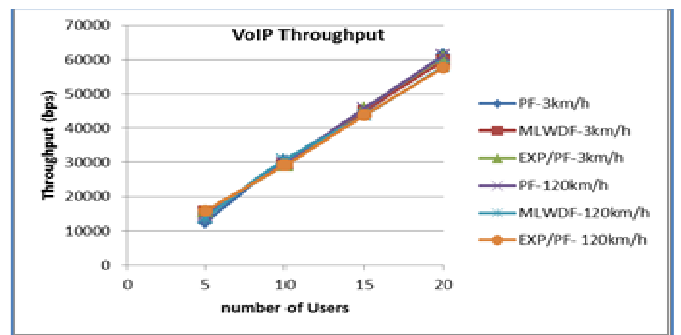

Fig. 14 Throughput for voip flows

Fig. 15 shows that the PF algorithm has the lowest packet loss ratio, while M-LWDF has the highest packet loss ratio, independently of the number of the users. However, the packet loss ratio decreases for EXP/PF scheduling algorithm as the number of the user's increases.

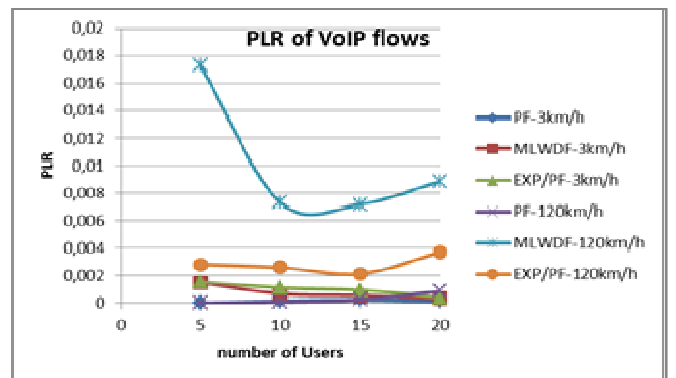

Fig.15 Packet Loss Ratio for voip flows

ACKNOWLEDGMENT

This work was supported in part by Laboratory Innov'COM of Higher School of Telecommunication of Tunis, and National Engineering School of Tunis.

The fairness index for the VoIP flows is presented in Fig. 16. It can be noticed that the fairness index for all scheduling algorithm reduces as long as the number of users is between 10 and 15. Then it starts to increase.

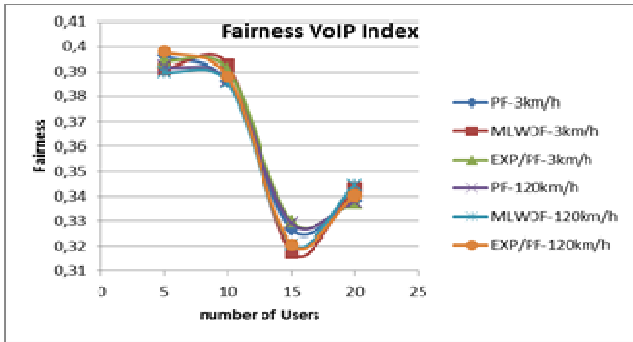

Fig. 16 Fairness for voip flows

Finally, Fig. 17 shows that the total cell spectral efficiency increases as long as the speed of users increases.

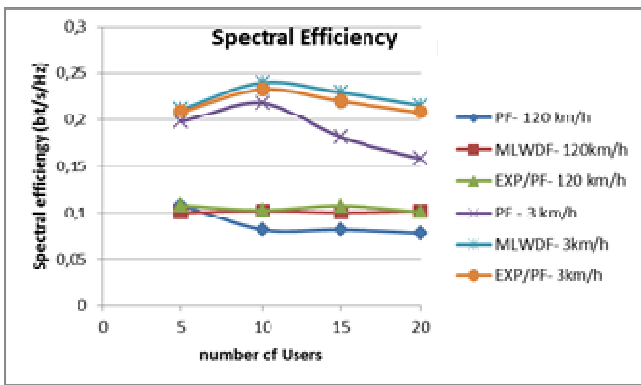

Fig. 17 Spectral efficiency

To conclude, PF scheduling algorithm is not suitable for video flows due to its high delay, packet loss ratio, and low throughput. The M-LWDF and EXP/PF scheduling algorithms have better performances for video flows in LTE Networks.

V. CONCLUSION

In this article, the effects of mobility on voice, video and best effort traffic are analyses with three different scheduling algorithms.

Using the LTE-SIM simulator, the study compares the performance of scheduling algorithms such as average system throughput, average packet delay, PLR, fairness and spectral efficiency via video and VoIP traffic in pedestrian and vehicular environments. It can be concluded that PF and EXP/PF are the most suitable scheduling algorithms for VoIP flows and MLWDF is better for Video flows in LTE networks.

The research shows the importance of right selection of scheduling strategy at a network base station. Future work may expand experiments using multi-cells and consider handover issues.

REFERENCES

- [1] H. Holma, A. Toskala, LTE for UMTS – OFDMA and SC-FDMA Based Radio Access, John Wiley & Sons, 2009.
- [2] White Paper, "Long Term Evolution (LTE): A Technical Overview" 2008.
- [3] 3GPP, Tech. Specif. Group Radio Access Network Requirements for Evolved UTRA (E-UTRA) and Evolved UTRAN (E-UTRAN), 3GPP TS25.913.
- [4] S. C. Nguyen, K. Sandrasegaran, and F. M. J. Madani, "Modeling and Simulation of Packet Scheduling in the Downlink LTE-Advanced," in Communications (APCC), 2011 17th Asia-Pacific Conference on, 2011, pp. 53-57.
- [5] A. Alfayly, I.-H. Mkwawa, L. Sun, and E. Ifeakor, "QoE-Based Performance Evaluation of Scheduling Algorithms over LTE," in Globecom Workshops (GC Wkshps), 2012 IEEE, 2012, pp. 1362-1366.
- [6] Biswapratap Singh Sahoo, Performance Comparison of Packet Scheduling Algorithms for Video Traffic in LTE Cellular Network, in International Journal of Mobile Network Communications & Telematics (IJMNC) Vol. 3, No.3, June 2013.
- [7] Giuseppe Piro, Luigi Alfredo Grieco, Gennaro Boggia, Francesco Capozzi, "Simulating LTE Cellular Systems: an Open Source Framework", Octobre 2010.
- [8] 3GPP, Tech. Specif. Group Radio Access Network - Physical Channel and Modulation (Release 8), 3GPP TS 36.211.
- [9] T. Dikamba, "Downlink Scheduling in 3GPP Long Term Evolution (LTE)". MSc Thesis, TUDelft, March 2011.
- [10] Giuseppe Piro, Luigi Alfredo Grieco, Gennaro Boggia, Rossella Fortuna, and Pietro Camarda, "Two-Level Downlink Scheduling for Real-Time Multimedia Services in LTE networks", IEEE Trans. Multimedia, 2011.
- [11] Yaser Barayan and Ivica Kostanic, Performance Evaluation of Proportional Fairness Scheduling in LTE, in Proceedings of the World Congress on Engineering and Computer Science 2013 Vol II WCECS 2013, 23-25 October, 2013.
- [12] Mohammad T. Kawser, Abduhu. R. Hasin, Hasib M. A. B. Farid, Adil M. J. Sadik, Ibrahim K. Razu, "Performance Comparison between Round Robin and Proportional Fair Scheduling Methods for LTE", in International Journal of Information and Electronics Engineering, Vol. 2, No. 5, September 2012.
- [13] Francesco Capozzi, Giuseppe Piro, Luigi Alfredo Grieco, Gennaro Boggia, and Pietro Camarda, "Downlink Packet Scheduling in LTE Cellular Networks: Key Design Issues and a Survey", IEEE Commun. Surveys and Tutorials, 2012.
- [14] P. Ameigeiras, J. Wigard, and P. Mogensen, "Performance of the MLWDF Scheduling Algorithm for Streaming Services in HSDPA". IEEE Trans. Veh. Technol. Conf., vol. 2, pp. 999-1003, Sep. 2004.
- [15] R. Basukala, H. Mohd Ramli and K. Sandrasegaran, "Performance Analysis of EXP/PF and M-LWDF in Downlink 3GPP LTE System". IEEE F. Asian Himalayas Conf., pp. 1-5, Nov. 2009.
- [16] T. Camp, J. Boleng, and V. Davies, "A Survey of Mobility Models for Ad Hoc Network Research," Wireless Commun. Mobile Comput., vol. 2, pp. 483-502, 2002.
- [17] R. Jain, D.-M. Chiu, and W. R. Hawe, A Quantitative Measure of Fairness and Discrimination for Resource Allocation in Shared Computer System: Eastern Research Laboratory, Digital Equipment Corporation, 1984.
- [18] Richard Musabe, Hadi Larjani and Glasgow, Evaluation of a New Scheduling Scheme for VoIP with Mobility in 3G LTE. The Fifth International Conference on Communication Theory, Reliability, and Quality of Service 2012.