

Numerical Investigation of Heat Transfer in a Channel with Delta Winglet Vortex Generators at Different Reynolds Numbers

N. K. Singh

Abstract—In this study the augmentation of heat transfer in a rectangular channel with triangular vortex generators is evaluated. The span wise averaged Nusselt number, mean temperature and total heat flux are compared with and without vortex generators in the channel at a blade angle of 30° for Reynolds numbers 800, 1200, 1600, and 2000. The use of vortex generators increases the span wise averaged Nusselt number compared to the case without vortex generators considerably. At a particular blade angle, increasing the Reynolds number results in an enhancement in the overall performance and span wise averaged Nusselt number was found to be greater at particular location for larger Reynolds number. The total heat flux from the bottom wall with vortex generators was found to be greater than that without vortex generators and the difference increases with increase in Reynolds number.

Keywords—Heat transfer, channel with vortex generators, numerical simulation, effect of Reynolds number on heat transfer.

I. INTRODUCTION

COMPACT heat exchangers find wide-spread deployment in diverse fields such as automobile industry, heating and air conditioning, power system, chemical engineering, electronic chip cooling and aerospace etc. The subject of heat transfer enhancement is of significant interest in developing compact heat exchanger to meet the objectives of high efficiency and low cost with the smallest volume and least weight possible.

There are two different methods for heat exchange enhancement: active vortex method and passive vortex method. The active vortex method is used to actively control the secondary flow and pressure drop so as to meet the required heat transfer rates even at the cost of increased pumping power. There is little use of this method in heat exchangers as the operating cost is very high. A few examples of active vortex method are the use of jets at different angles from the heat transfer surface into the boundary layer, and the generation of a secondary flow through acoustic excitation. Using longitudinal or latitudinal vortex generators for heat exchange enhancement is known as the passive vortex method. Delta wing, rectangular wing, delta winglet, rectangular winglet, trapezoidal delta wing, dimpled surfaces, ribs, and fins all are types of vortex generators. A great deal of research has been done using this method since it is efficient

and has low maintenance and operating cost in heat exchangers.

Vortex generator is a kind of passive heat transfer enhancing device which is attached to the duct walls or fin surfaces and protrudes into the flow at an angle of attack to the flow direction. It can be stamped on or punched out from the fin. Using VGs, the fluid flow can be strongly disturbed because of the generation of vortex when fluid flows over it. The vortex generator not only disturbs the flow field, disrupts the growth of the boundary layer, but also makes fluid swirl and causes a heavy exchange of core and wall fluid, leading to the enhancement of heat transfer. The vortices may be divided into transverse vortex (TV) and longitudinal vortex (LV) according to its rotating axis direction. The axes of TVs lie perpendicular to the main flow direction, while LVs have their axes parallel to the main flow direction, thus they are also called stream wise vortices. In general, the LVs have been reported to be more efficient than TVs for heat transfer enhancement. The basic principle of vortex generators (VGs) is to induce secondary flow, particularly longitudinal vortices, which disturb or cut off the thermal boundary layer developed along the wall and remove the heat from the wall to the core of the flow by means of large-scale turbulence.

The first use of longitudinal vortex was mentioned by [1] and since then research on LVGs has increased. A delta winglet pair kept at an angle of attack is very effective as the longitudinal vortices generated by it persist for hundreds of wing chords down-stream of the winglets in the case of laminar channel flow [2]. In the case of the heat exchangers the flow on gas side is usually laminar, because on this side the fin spacing is small and the mean velocity is low. Reference [3] found that the delta winglets provided a higher overall heat transfer enhancement, compared to cubes placed on a flat plate. Experimental investigation of [4] showed that the heat transfer is locally enhanced in the region where two neighboring vortices impose a flow towards the surface and the heat transfer locally decreases where the vortices impose a flow away from the surface. Reference [4] studied the structure of velocity and temperature fields in laminar channel flows with wing-type longitudinal vortex generators and concluded that local enhancement of heat transfer coefficient increases by a factor of three compared to its value in a wing less channel. Reference [5] carried out an experimental comparison of delta wings, delta winglets, rectangular wings and rectangular winglets. Heat transfer and skin friction characteristics in a channel with built-in wing-type vortex

Dr. N. K. Singh is with the National Institute of Technology, Kurukshetra, 136119, India (phone: +919671200887; e-mail: kant.nirmal@gmail.com).

generators at angle of attack (β) of 26° and Reynolds number of 500 were studied by [6]. They concluded that combined spanwise averaged Nusselt number shows increase of 34% even at the exit of a long channel. Reference [7] studied heat transfer and flow structure in laminar and turbulent flows in a rectangular channel with longitudinal vortices whereas [8] carried out numerical and experimental study of flow structure and heat transfer effects of longitudinal vortices in a fully developed channel flow. They defined a performance equality factor which indicates heat transfer enhancement for a given pressure loss penalty. Based on the value of this factor, they conclude that the performance of the winglet is best for β of 15° . Same trend was observed by [9], when the performance evaluation is done taking into account the energy transfer and the losses due to the thermodynamic irreversibilities. Reference [10] attempted unsteady three-dimensional Direct Numerical Simulation (DNS) and Large Eddy Simulation (LES) of heat and fluid flow in a plate-fin heat exchanger with thick rectangular winglet type vortex generators at Reynolds and Prandtl numbers of 2000 and 0.71, respectively. In the numerical investigations, except for [10], the winglet is idealized as of zero thickness. In the present study we consider winglet of finite thickness to render the computations more realistic. Reference [11] numerically investigated subsonic flow separation over a NACA0012 airfoil and flow separation control with vortex generators. An immersed boundary method was used to model both the passive and active vortex generators. They observed that passive vortex generators reduced the averaged separation zone by more than 80% while the active vortex generators completely eliminated separation. Very recently, a comprehensive data set at a channel Reynolds number of 300,000 has been created by [12].

The vortex generators in this study are placed at a blade angle of 30° in a rectangular channel. These vortices create the down wash flow towards the lower channel wall while the up wash flow is away from the wall which is found in the outside region of the vortices. Along the downstream direction, the secondary velocity vectors decreases while the distance between the vortex cores increases. Thinning of the thermal boundary layer thus occurs in between the two vortices.

Interaction of the vortices with the boundary layer formed on the channel walls is very complex and still a matter of research. In the present work an attempt is being made to understand the underlying flow physics and heat transfer mechanism.

II. PROBLEM DEFINITION & METHODS

A. Geometric Model

The rectangular channel has cross section dimensions of $25\text{cm} \times 10\text{cm}$. Length of the channel is 200cm. The delta vortex generators have the dimensions length(l) \times breadth(w) \times height(b) of $4\text{cm} \times 0.4\text{cm} \times 2\text{cm}$. The blade angle for the delta vortex generators is taken as 30° (Fig. 1). The wall material is taken as Aluminum and the fluid flowing is water. The flow in the channel is with 3% turbulent intensity and enters the channel with uniform constant velocity across the

cross section. The backflow turbulent intensity at outlet is also taken as 3%. The Reynolds numbers are chosen as 800, 1200, 1600 and 2000. Shown in Fig. 2 is the isometric view of the channel along with vortex generators.

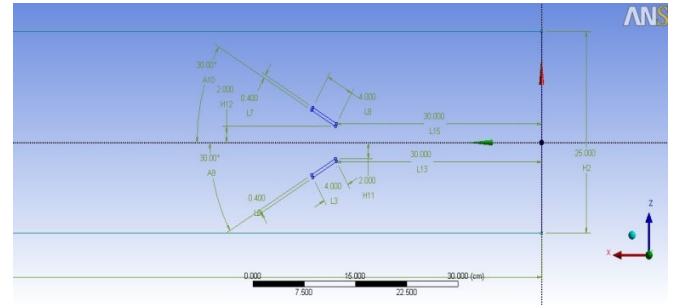

Fig. 1 Geometric model showing arrangement of blades (dimensions in cm)

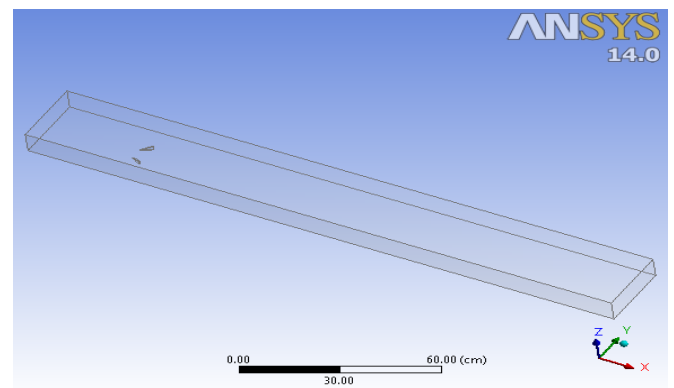

Fig. 2 Isometric view of the entire channel

B. Grid Generation

In this study ANSYS Workbench was used as the meshing tool. A structured non uniform grid was generated. Fig. 3 shows the isometric view of the fluid domain meshing whereas fine meshing near the vortex generators is depicted in Fig. 4. Fine meshing is needed near the wall region to capture the boundary layer on the wall. The whole fluid domain has all the elements as tetrahedral elements. Mapped Face Meshing option from the ANSYS Workbench meshing tool was used to generate this kind of structured non uniform meshing. A bias factor of 10 was used to make the grids near the wall and the vortex generators fine to capture the boundary layer

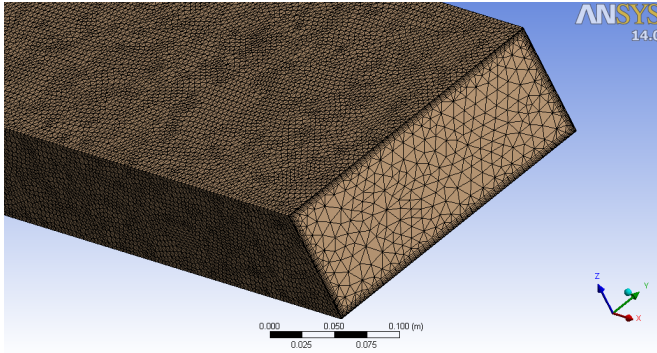

Fig. 3 Isometric view of the fluid domain meshing

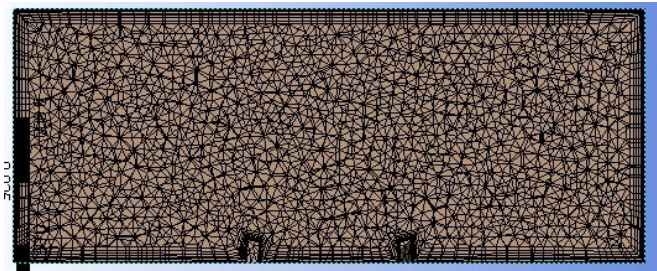

Fig. 4 Tetrahedral non uniform grid around the vortex generators (cross sectional view)

C. FLUENT Setup

FLUENT 14.5 was used for CFD analysis in this study. Importing the mesh files created in ANSYS Workbench, the model is setup to allow energy equation in a Realizable $k-\epsilon$ model with enhanced wall treatment. The fluid in this study is water with a constant density of 998.2 kg/m^3 , dynamic viscosity of 0.001003 kg/m.s , the constant pressure specific heat of 4182 J/Kg-K , and thermal conductivity of 0.6 W/m.K . The operating condition on the interior of the channel is fluid while the boundary conditions tabulated in Table I are applied on the rectangular channel including the inlet and outlet channel. A temperature of 373K is applied on the surface of the heated section which is the bottom surface of the rectangular channel and all the surface of the vortex generator. The inlet has been given an inlet temperature of 300 K and a specific velocity based on the Reynolds number corresponding to the chosen Reynolds number. The outlet has zero pressure thus implying ambient condition. The walls of the whole channel, as well as surfaces of the vortex generator, have been given the no slip boundary condition. A second order upwind discretization method has been used for energy and momentum. Convergence is based on the absolute criteria of continuity, x velocity, y velocity and z velocity being equal to 10^{-3} and energy equal to 10^{-6} . This means that the solution will converge once the residuals reach the above mentioned mark. The model is computed from the inlet surface and 1000 iterations were given for the solution to converge.

The flow is with turbulent intensity of 3 percent and the velocity of the flow is calculated from

$$Re = \frac{\rho V H}{\mu} \quad (1)$$

where,

Re = Reynolds number

ρ = density of the fluid, (kg/m^3)

V = mean velocity of fluid flow, (m/s)

H = characteristic length or Channel Height (m)

μ = dynamic viscosity of the fluid, (kg / (m.s))

Density of the water is 998.2 kg/m^3 and the dynamic viscosity of water is $.001003 \text{ kg / (m.s)}$. The Prandtl number for water in this study is taken as 6.99.

The span wise averaged Nusselt number was calculated as follows:

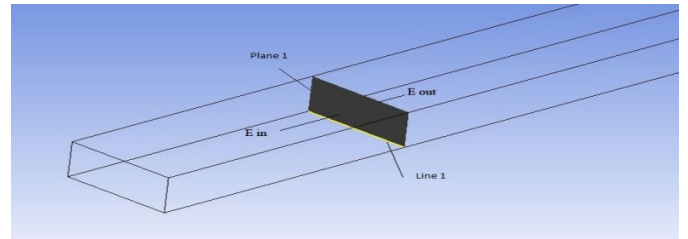

Fig. 5 Calculation of span-averaged Nusselt number.

Total mass flow rate entering the Plane 1 shown in Fig. 5 is,

$$\dot{m} = \int \rho u dA \quad (2)$$

If we assume the fluid entering the Plane 1 with some constant velocity u_m , so

$$\dot{m} = \rho u_m A \quad (3)$$

Equating (2) and (3)

$$u_m = \frac{\int \rho u dA}{\rho A} \quad (4)$$

Now balancing energy at Plane 1

$$\rho A u_m c_p T_m = \int \rho c_p u T dA \quad (5)$$

We calculate the mean temperature T_m as

$$T_m = \frac{\int \rho c_p u T dA}{\rho c_p u_m A} \quad (6)$$

The spanwise-averaged Nusselt number at Line 1 shown in Fig. 5 is

$$Nu = \frac{h_{avg} H}{k} \quad (7)$$

Now h_{avg} the averaged convection coefficient at Line 1 is calculated from

$$q_{avg}^{\bullet} = h_{avg} (T_s - T_m) \quad (8)$$

where, T_s = Bottom wall Surface Temperature.

T_m = mean temperature of fluid entering the Plane 1

So by knowing the q_{avg}^{\bullet} along the Line 1 we can calculate the spanwise-averaged Nusselt Number.

In this case, since the flow is through a rectangular channel, the hydraulic diameter is taken as

$$H_d = \frac{4BH}{2(B+H)} \quad (9)$$

hence $H_d = 0.0571$ m

The turbulent intensity of the fluid entering the rectangular channel is taken as 3%.

Boundary conditions specify the flow and thermal variables on the boundaries of the physical model. The computational domain uses following boundary conditions. Table I shows the boundary conditions assigned in FLUENT.

TABLE I
 BOUNDARY CONDITIONS

Zone	Assigned Boundary Type
Inlet	Velocity Inlet, Inlet fluid temperature = 300K
Outlet	Pressure Outlet, 0 Pa gauge
Bottom wall	Wall (No Slip), Constant Temperature = 373 K
Top wall	Wall (No Slip), Constant Heat Flux = 0 W/m ²
Side walls	Wall (No Slip), Constant Heat Flux = 0 W/m ²
Vortex Generators	Wall (No Slip), Constant Temperature = 373 K

III. RESULTS & DISCUSSION

Numerical simulation of the flow in the channel with heated bottom wall has been carried out. In this chapter feature of the flow at a blade angle 30° and at different Reynolds number are discussed in detail.

A. Analysis of Performance of Vortex Generator at Reynolds Number 800, 1200, 1600 and 2000

The variation of span wise averaged Nusselt number was calculated at different values of x at Reynolds number of 800, 1200, 1600, and 2000. Studies in channel without winglet and with winglet pair were carried out. It shows that the span wise averaged Nusselt number increases with the increment of Reynolds no. at a particular x . Figs. 6 to 9 show the behavior at these Reynolds number with blade angle 30°. The increment in the span wise averaged Nusselt number can be observed from these figures.

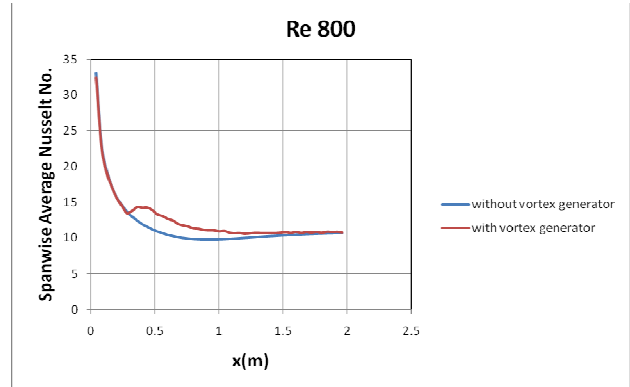

Fig. 6 Contours of wall adjacent temperature at Re 2000

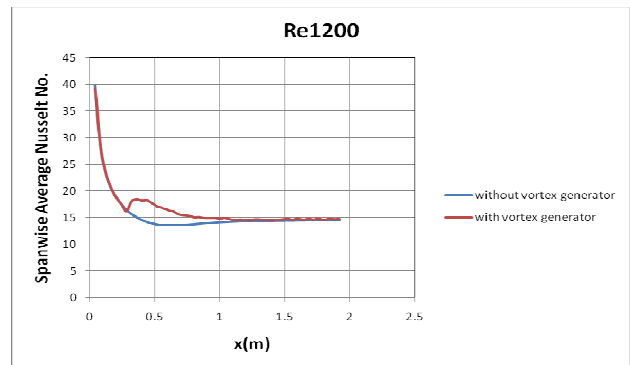

Fig. 7 Contours of wall adjacent temperature at Re 2000

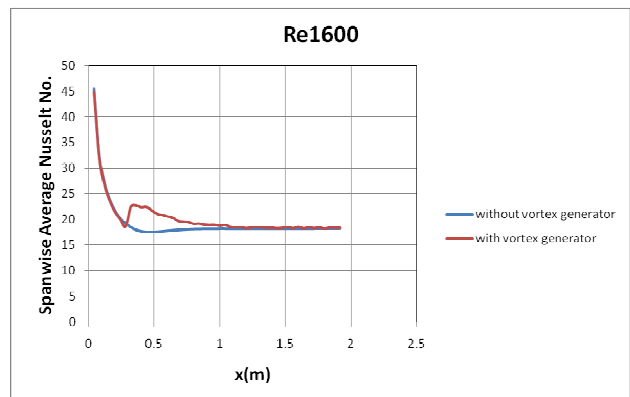

Fig. 8 Contours of wall adjacent temperature at Re 2000

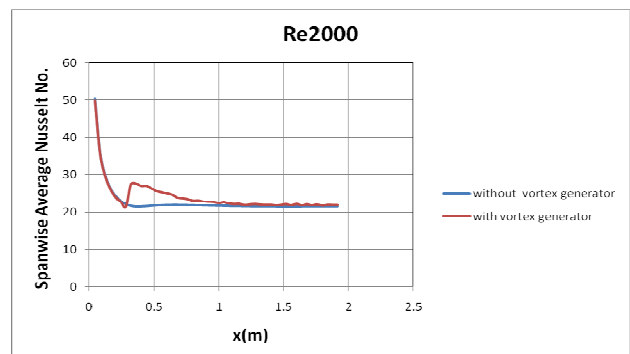

Fig. 9 Contours of wall adjacent temperature at Re 2000

Figs. 6 to 9 show the effect of vortex generators on the spanwise averaged nusselt number. The comparison between the plots of spanwise averaged Nusselt number with and without vortex generators shows that there is a considerable increase in Nusselt number near the vortex generator region and this effect decreases as we move far from the vortex generator region in the stream wise direction.

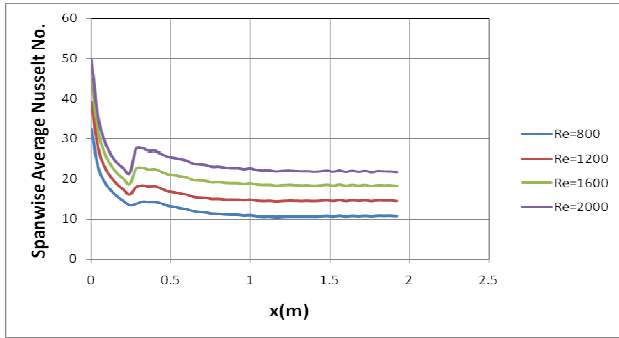

Fig. 10 Variation of mean temperature along x at different Reynolds numbers

Fig. 10 shows the combined plot for all the cases discussed. The plot shows that with increase in Reynolds number the span wise averaged Nusselt number increases for the particular x. It is also observed that with increase in the Reynolds number the rate of increase in span wise averaged Nusselt number near the vortex generator region high, implying that the vortex generators are more effective at higher Reynolds number and causes greater heat transfer from the bottom wall.

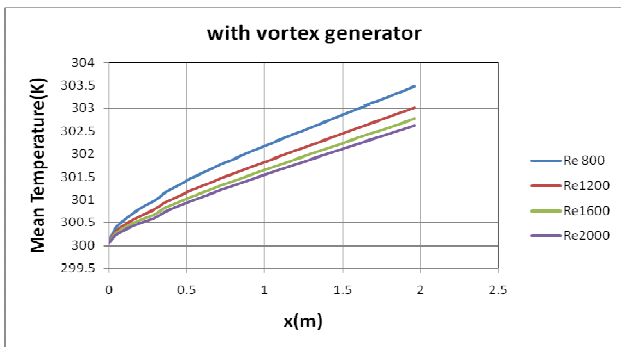

Fig. 11 Variation of mean temperature along x at different Reynolds numbers

Fig. 11 shows the effect of vortex generator on the mean temperature. It can be seen that after vortex generator region, mean temperature curve diverges from the curve without vortex generator. From Fig. 11 we can observe that mean temperature decreases as Reynolds number increases at a particular x.

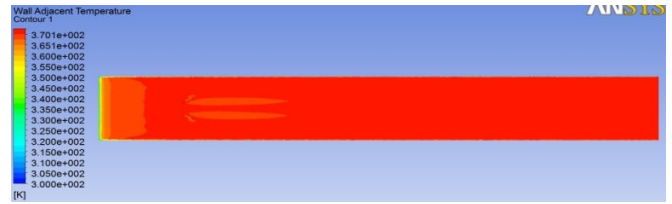

Fig. 12 Contours of wall adjacent temperature at Re 800



Fig. 13 Contours of wall adjacent temperature at Re 1200

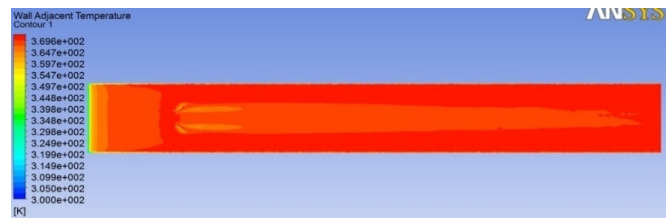

Fig. 14 Contours of wall adjacent temperature at Re 1600



Fig. 15 Contours of wall adjacent temperature at Re 2000

Figs. 12 to 15 show the comparison of the bottom wall adjacent temperature at Re 800, 1200, 1600 and 2000 with vortex generators. The use of vortex generators causes the wall adjacent temperature near the bottom wall to decrease, resulting in an increase in the heat flux, hence improved heat transfer and increase in the Nusselt number in that region. With increase in Reynolds number the wall adjacent temperature near the bottom wall decrease so at higher Reynolds number performance increases.

B. Validation

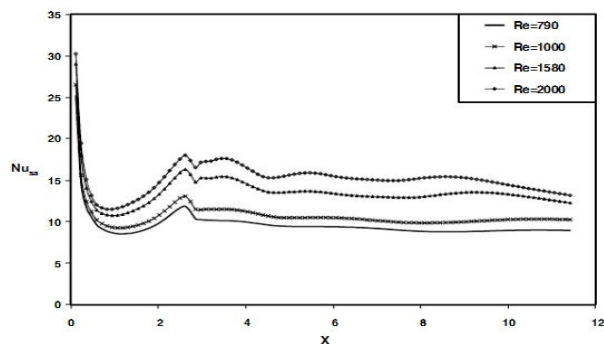

Fig. 16 Effect of Reynolds number on axial variation of average Nusselt number [13]

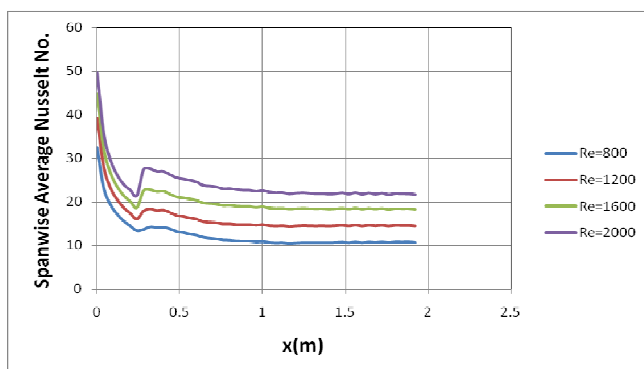

Fig. 17 Effect of Reynolds number on axial variation of average Nusselt number: Present work

Figs. 16 and 17 show the comparison between the work of [13] and the present work. It is seen that the results from present work compare well with data of [13]. The difference between the values of Nusselt number is due to difference in the channel and vortex generators dimensions.

IV. CONCLUSIONS

In this study the augmentation of heat transfer in a rectangular channel with triangular vortex generators was evaluated. The span wise averaged Nusselt number, mean temperature and total heat flux were compared with and without vortex generators in the channel at a blade angle of 30° for Reynolds number of 800, 1200, 1600, and 2000. The use of vortex generators increases the span wise averaged Nusselt number compared to the case without vortex generators considerably. At a particular blade angle, by increasing the Reynolds number the overall performance increases and span wise averaged Nusselt number was found to be greater at particular location for larger Reynolds number. The mean temperature of the bulk fluid at a particular location in the flow direction was increased by the use of vortex generators. The total heat flux from the bottom wall with vortex generators was found to be greater than that without vortex generators and the difference increases with increase in Reynolds number.

REFERENCES

- [1] Schubauer, G. B. and Spangenberg, W. G., "Forced mixing in boundary layers", *J. Fluid Mech.*, Vol. 8, 1, 1960, pp.10-32.
- [2] Fiebig, M., Brockmeier, U., Mitra, N.K., Guntermann, T., "Structure of velocity and temperature fields in laminar channel flows with longitudinal vortex generators," *Numerical Heat Transfer*, A-15, 1989, pp. 281–302.
- [3] Edwards, F.J., Alker, G.J.R., "The improvement of forced convection surface heat transfer using surface protrusions in the form of (a) cubes and (b) vortex generators", *Proceedings of the Fifth International Heat Transfer Conference Tokyo*, 2, 1974, pp. 2244–2248.
- [4] Katoaka, K., Doi, H., Komai, T., "Heat/mass transfer in Taylorvortex flow with constant axial flow rates", *International Journal of Heat and Mass Transfer*, 20, 1977, pp. 57–63.
- [5] Fiebig, M., Kallweit, P., Mitra, N.K., Tiggelbeck, S., "Heat transfer enhancement and drag by longitudinal vortex generators in channel flow", *Experimental Thermal and Fluid Science*, 4, 1991, pp. 103–114.
- [6] Biswas, G., Chattopadhyay, H., "Heat transfer in a channel with built-in wing-type vortex generators", *International Journal of Heat and Mass Transfer*, 35, 1992, pp. 803–814.
- [7] Deb, P., Biswas, G., Mitra, N.K., "Heat transfer and flow structure in laminar and turbulent flows in a rectangular channel in longitudinal vortices", *International Journal of Heat and Mass Transfer*, 38, 1995, pp. 2427–2444.
- [8] Biswas, G., Torii, K., Fujii, D., Nishino, K., "Numerical and experimental determination of flow structure and heat transfer effects of longitudinal vortices in a channel flow", *International Journal of Heat and Mass Transfer*, 39, 1996, pp. 3441–3451.
- [9] Biswas, G., Deb, P., Biswas, S., "Generation of longitudinal streamwise vortices – A device for improving heat exchanger design", *Journal of Heat Transfer (ASME)*, 116, 1994, pp. 588–597.
- [10] Sohankar, A., Davidson, L., "Numerical study of heat and fluid flow in a plate-fin heat exchanger with vortex generators", *Turbulence Heat and Mass Transfer*, 4, 2003, pp. 1155–1162.
- [11] Shan, H., Jiang, L., Liu C., Love, M. and Maines, B., "Numerical study of passive and active flow separation control over a NACA0012 airfoil", *Computers and Fluids*, 2008, 37, pp.975-992.
- [12] Henze, M., Wolfersdorf, J., Weigand, B., Deitz, C. F. and Neumann, S. O., "Flow and heat transfer characteristics behind vortex generators - A benchmark dataset", *Int. J. Heat Fluid Flow*, 2011, 32, pp. 318-328.
- [13] Hiravennavar, S. R., Tulapurkara, E.G., Biswas, G., "A note on the flow and heat transfer enhancement in a channel with built-in winglet pair", *International Journal of Heat and Fluid Flow*, 2007, 28, 2, pp. 299-305.