

# Sizing the Protection Devices to Control Water Hammer Damage

I. Abuiziah, A. Oulhaj, K. Sebari, D. Ouazar

**Abstract**—The primary objectives of transient analysis are to determine the values of transient pressures that can result from flow control operations and to establish the design criteria for system equipment and devices (such as control devices and pipe wall thickness) so as to provide an acceptable level of protection against system failure due to pipe collapse or bursting. Because of the complexity of the equations needed to describe transients, numerical computer models are used to analyze transient flow hydraulics. An effective numerical model allows the hydraulic engineer to analyze potential transient events and to identify and evaluate alternative solutions for controlling hydraulic transients, thereby protecting the integrity of the hydraulic system. This paper presents the influence of using the protection devices to control the adverse effects due to excessive and low pressure occurs in the transient.

**Keywords**—Flow Transient, Water hammer, Pipeline System, Surge Tank, Simulation Model, Protection Devices.

## I. INTRODUCTION

IN a water pipeline system, system flow control is an integrated part of its operation, for instance, the opening and closing of valves, and starting and stopping of pumps. When these operations are performed very quickly, they can cause hydraulic transient phenomena.

Transients analysis are important in hydraulic systems because it can cause rupture of pipe and pump casings, pipe collapse, vibration, excessive pipe displacements, pipe-fitting, support deformation and/or failure, and vapor cavity formation.

Several methods have been introduced and used to analyze water hammer problem like the energy [1], arithmetic [2], graphical, characteristics, algebraic, implicit and linear analyzing [3]-[5], Euler and Lagrangian based method [6], and decoupled hybrid methods [7]. The characteristics method converts the two partial differential equations of motion and continuity into four total differential equations. These equations are then expressed in finite differential form, using the method of specified time intervals, and solutions are carried out with the use of digital computer [5], [8]-[10]

Karney et al. used the characteristics with some modification to obtain more efficient calculations of transient in simple pipe system [11], while Tezcan et al. used this method to analyze the transient in complex pipe systems [10]-

Itissam Abuiziah is Ph.D student, with the Rural Engineering Department, Institute of Agronomy and Veterinary Hassan II, Rabat, Morocco (e-mail: itissam2002@yahoo.com).

Ahmed Oulhaj and Karima Sebari are with the Rural Engineering Department, Institute of Agronomy and Veterinary Hassan II, Raba, Morocco.

Driss Ouazar is with the Civil Engineering, Ecole Mohammadia d'Ingénieurs, Rabat, Morocco.

[14]. Jung et al. compared between the results obtained for both simple and complex pipe systems by using the method of characteristics, and the results are more accurate in the simple systems [15]. The characteristics method has been used to study the oil pipe systems [16], and cooling networks in nuclear plants [3], [17]. Recently Nabi et al. used this method to analyze real pipe systems in Pakistan; also they study the effect of installing protection device on the system [18].

To reduce the dangerous effects of water hammer; the surge devices have been added to the pipeline systems. Most of these protection equipments aim to protect against unfavorable large pressure fluctuations tend to maintain the pressure at a nearly constant value at some fixed places, or tend to keep the pressure from exceeding a predetermined value [3], [9], [19]. Several criteria can be adopted to determine which surge devices are to be used such as the effectiveness, dependability, evaluation of cost character and frequency of maintenance requirement over an exceeded period [5].

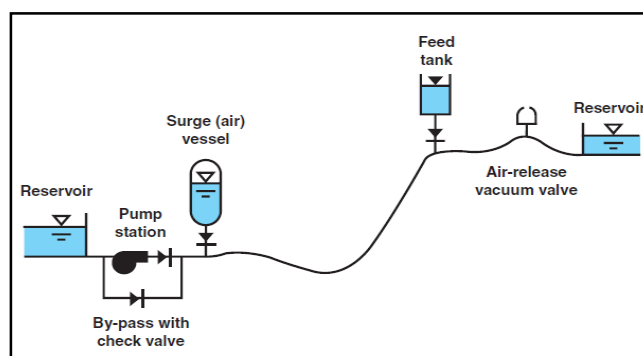

Fig. 1 Typical locations for vinous surge protection devices [20]

In this work computer software has been developed in order to simulate and design hydraulic transients in pipeline systems.

## II. PROBLEM STATEMENT

Transients can produce large pressure forces and rapid fluid acceleration into a water pipeline system. These disturbances may result in device failures, system fatigue or pipe ruptures, and even the backflow/intrusion of dirty water. Many transient events can lead to water column separation, which can result in catastrophic pipeline failures. Thus, transient events cause health risks and can lead to increased leakage or decreased reliability.



Fig. 2 Transient-caused failure, Super-aqueduct of Puerto Rico

Typical events that require transient considerations include:

1. Pump startup or shutdown;
2. Valve opening or closing (variation in cross-sectional flow area);
3. Changes in boundary pressures (e.g., losing overhead storage tank, adjustments in the water level at reservoirs, pressure changes in tanks, etc.);
4. Rapid changes in demand conditions (e.g., hydrant flushing);
5. Changes in transmission conditions (e.g., main break or line freezing);
6. Pipe filling or draining—air release from pipes; and
7. Check valve or regulator valve action.

The identification and calculation of pressures, velocities, and other abnormal behavior resulting from the hydraulic transients make possible the effective use of various control strategies, such as the

1. Selection of pipes and fittings to withstand the anticipated pressures;
2. Selection and location of the proper control devices to alleviate the adverse effects of transients; and
3. Identification of proper start-up, operation, and shutdown procedures for the system.

### III. MATERIALS AND METHODS

The simplified equations that govern unsteady flow in pipelines are motion and continuity equations which solved together ((1) and (2)), since the two equations provide two unknowns **H** and **V**. The method of characteristics used to transform the partial differential equations into total differential equations.

$$\frac{\partial H}{\partial x} + \frac{1}{g} \frac{\partial V}{\partial t} + \frac{fV|V|}{2gD} = 0 \quad (1)$$

$$\frac{\partial H}{\partial t} + \frac{a^2}{g} \frac{\partial V}{\partial x} = 0 \quad (2)$$

where **H** is the piezometric head, **V** is the flow velocity, **x** is the distance along the pipe, **t** is time, **g** is the acceleration of gravity, **f** is the pipe friction factor (assumed constant), **D** is the pipe diameter, and **a** is the celerity of a pressure wave in the pipeline.

Numerical model has been developed and use to analyze hydraulic transients due to the complexity of the equations needed to describe the transients. An effective numerical model allows the hydraulic engineer to analyze potential transient events and to identify and evaluate alternative solutions for controlling hydraulic transients, thereby protecting the integrity of the hydraulic system.

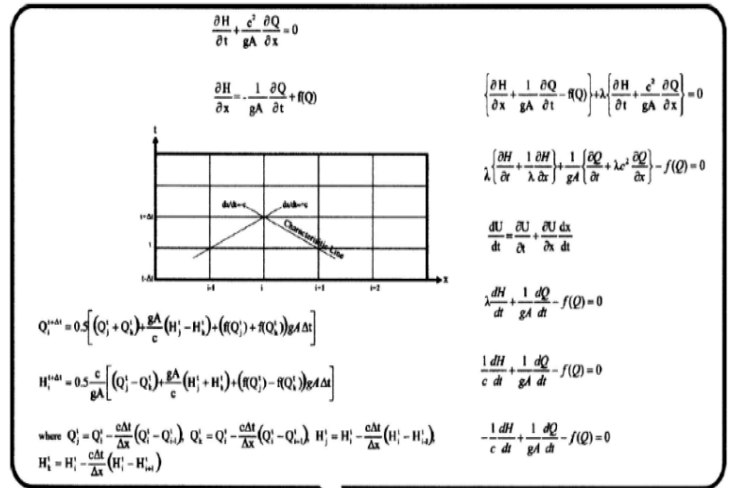

Fig. 3 Ordinary engineer will often become lost in maze of equations [6]

To reduce the dangerous effects of water hammer; the protection devices have been added to the pipeline systems, examples of protection devices are shown in the following figures.

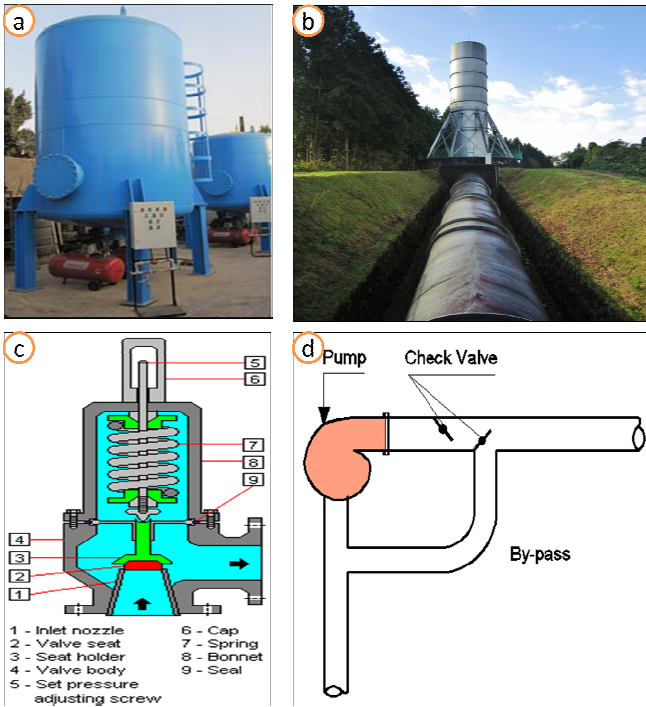

Fig. 4 Examples of protection devices (a) Closed surge tank (b) Open surge tank (c) Pressure relief valve and (d) By-pass

#### IV. SIMULATION RESULTS

In order to demonstrate the use of characteristics method for transient analysis two problems were solved.

1. Single pipeline with a reservoir at upstream end and open valve downstream is considered.
2. Pump feeds a reservoir at upstream end.

Case 1: A reservoir connected to a horizontal pipeline and a butterfly valve at downstream end. The pipe characteristics are shown in Fig. 5, the pipe diameter and the initial opening of the valve is 50%.

Closing the valve instantly cause speed cancellation, an increase in pressure, a radial and longitudinal deformation of the pipe and an increase in liquid density.

In order to minimize the effect of overpressure and low pressure; relief valve device have been studied in this case:

The simulation results are shown in the following graphs:

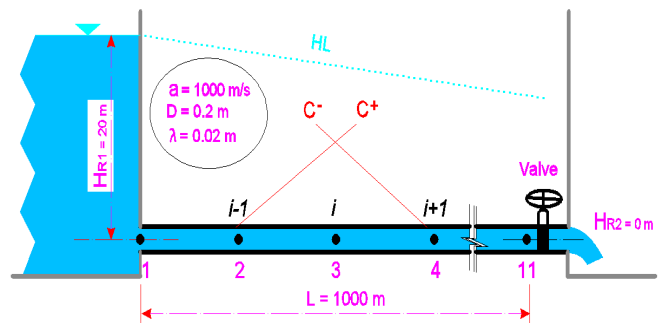

Fig. 5 Simple reservoir valve system

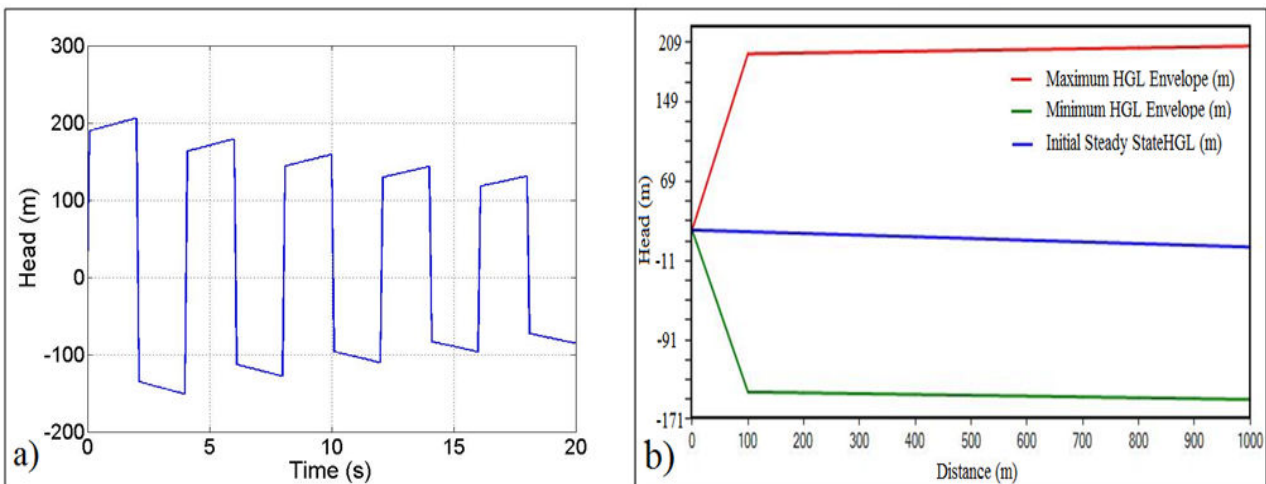

Fig. 6 Transients in pipeline system (Instant valve closure) (a) Head change versus time at the valve) and (b) Hydraulic Grade Lines (Without protection)

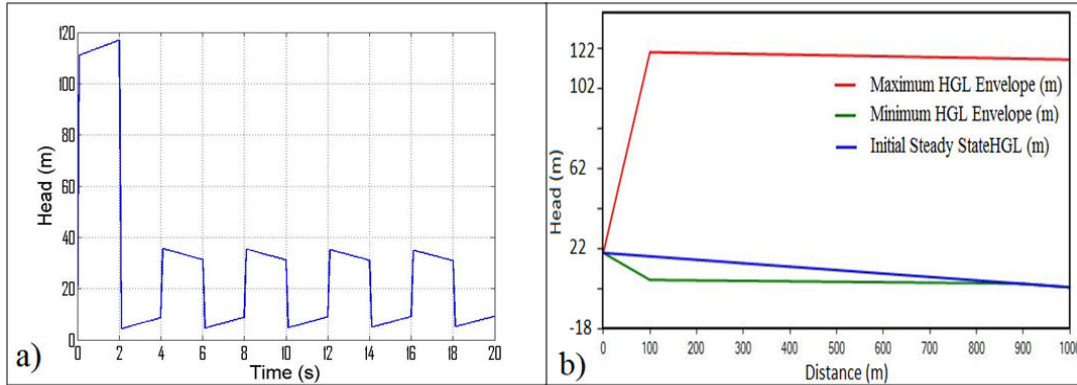

Fig. 7 Transients in pipeline system (Instant valve closure) (a) Head change versus time at the valve and (b) Hydraulic Grade Lines (with pressure relief valve protection)

The simulation results for unprotected pipeline show that the maximum and minimum pressures are nearly about 205 m and -150 m respectively, while the maximum pressure is about 116 m when relief valve is used.

**Case2:** A pump feeds a reservoir where the water level is at elevation HR = 30 m, through a conduit having the following characteristics, L = 1000 m, D = 0.2 m,  $\lambda = 0.02$ , and a = 1000

m/s. Flow delivered by the pump station is Q = 30 l/s. At a given moment the pump is stopped immediately after a power outage.

In order to minimize the effect of overpressure and low pressure; the following devices have been studied in this case:

1. Open surge tank
2. Closed surge tank
3. By-pass.

The simulation results are shown in the following graphs:

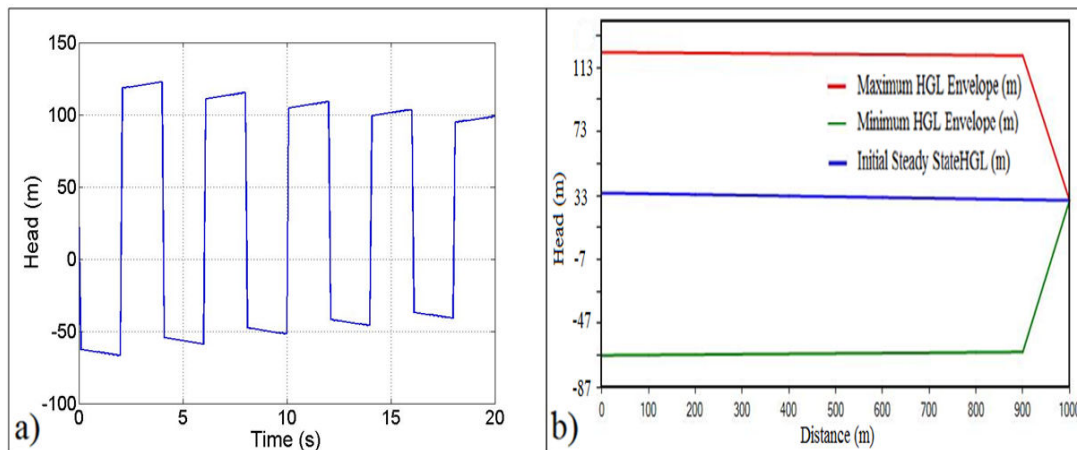

Fig. 8 Transients in a pumping system (a) Head change versus time at the pump and (b) Hydraulic Grade Lines (without Protection)

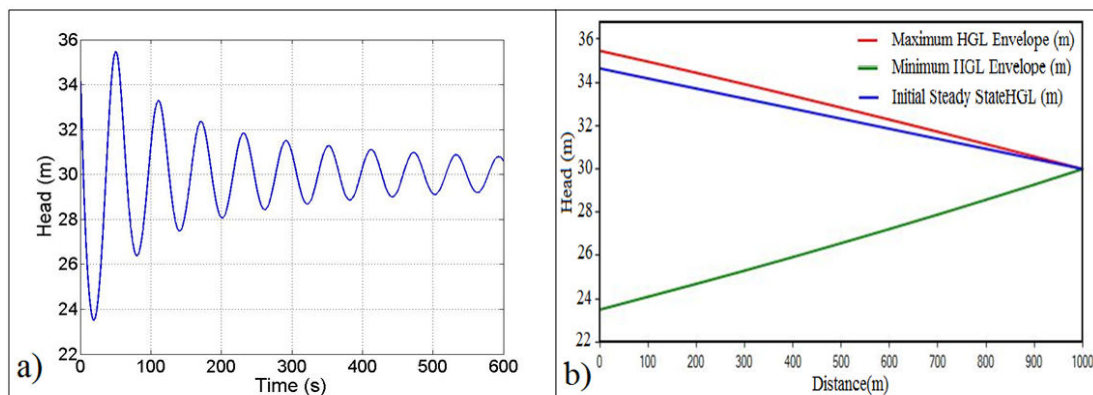

Fig. 9 Transients in a pumping system (a) Head change versus time at the pump and (b) Hydraulic Grade Lines (with open surge tank protection)



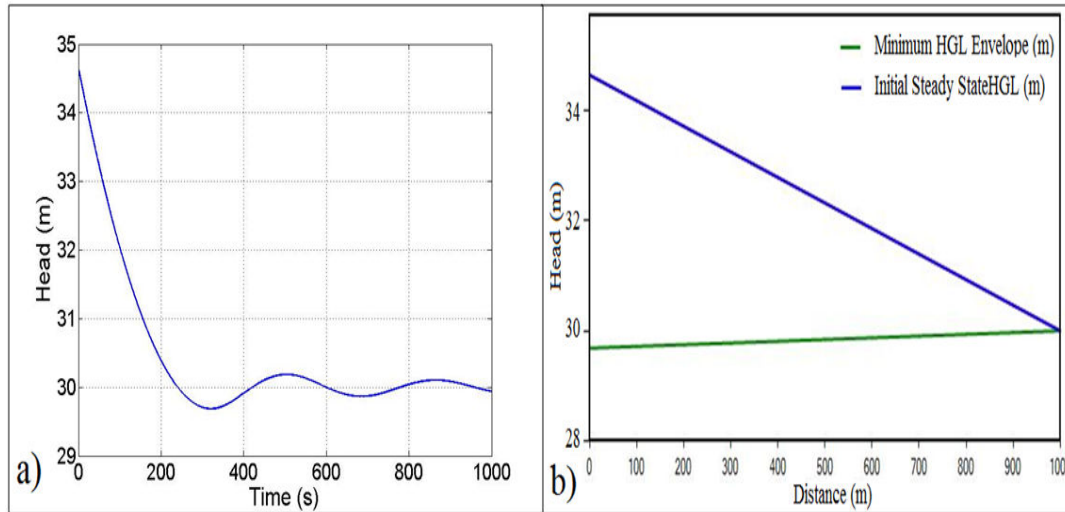

Fig. 10 Transients in a pumping system (a) Head change versus time at the pump and (b) Hydraulic Grade Lines (with closed surge tank Protection)

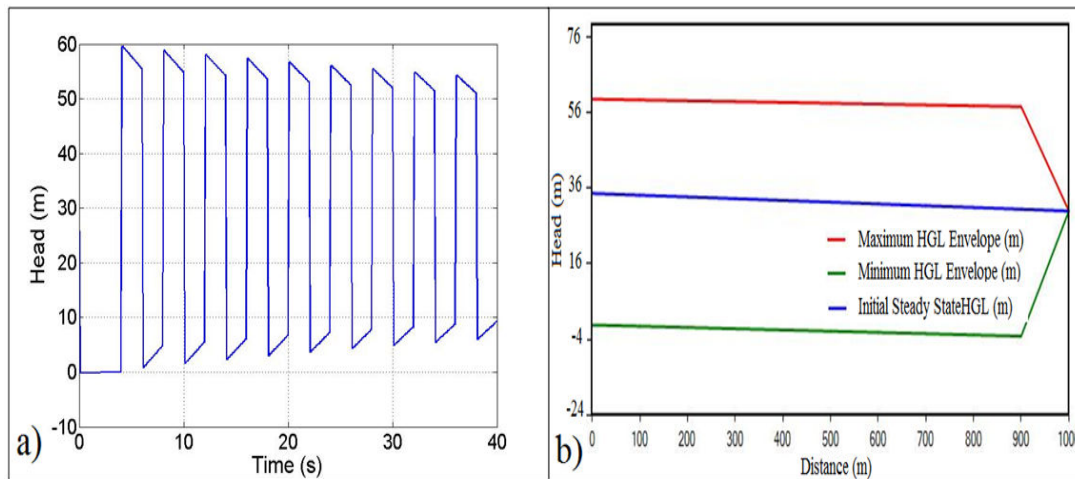

Fig. 11 Transients in a pumping system (a) Head change versus time at the pump and (b) Hydraulic Grade Lines (with By-pass Protection)

The simulation results for unprotected pipeline shows that the maximum pressure in the pipe is slightly greater than 120m, But by using the open surge tank, the maximum and minimum pressures at the surge tank location become only about 35m and 30m respectively, and also by using a closed surge tank with a capacity of  $3\text{m}^3$ , the maximum pressure at the closed surge tank is only about 35m, while by using the by-pass it reduces to 59m.

Several criteria can be adopted to determine which surge devices are to be used, such as the effectiveness, dependability, evaluation of cost character and frequency of maintenance requirement over an exceeded period.

System flow control operations are performed as part of the routine operation of a water distribution system, examples of system flow control operations include opening and closing valves, starting and stopping pumps, and discharging water in response to fire emergencies. These operations cause hydraulic transient phenomena, especially if they are performed too quickly. Proper design and operation of all aspects of a hydraulic system are necessary to minimize the

risk of system damage or failure due to hydraulic transients.

Potentially, water hammer can create serious consequences for pipeline designers if not properly recognized and addressed by analysis and design modifications. Three principal design tactics for mitigation of water hammer are

1. Alteration of pipeline properties such as profile and diameter,
2. Implementation of improved valve and pump control procedures, and
3. Design and installation of surge control devices.

#### V. CONCLUSIONS

Transients can introduce large pressure forces and rapid fluid accelerations into a piping system. These disturbances may result in pump and device failures...etc, due to the devastating effects that a hydraulic transient can cause, its analysis is very important in determining the values of transient pressures that can result from flow control operations and to establish the design criteria for system equipment and

devices so as to provide an acceptable level of protection against system failure due to pipe collapse or bursting.

Hydraulic transient analysis is an effective and reliable tool to determine the needs for surge protection systems against transient surges.

#### REFERENCES

- [1] B. W. Karney, "Energy relations in transient closed-conduit flow." *Hydraulic Engineering*, 116:10, 1180-1196, 1990.
- [2] Z. Zarzycki and S. Kudzma, "Simulation of transient flows in a hydraulic system with a long liquid line." *Theoretical and applied mechanics*, 45:4, 853-871, 2007. B. Smith, "An approach to graphs of linear forms (Unpublished work style)," unpublished.
- [3] M. H. Chaudhry, *Applied hydraulic transient*, Second edition Ed., Van Nostrand Reinhold Company Inc, New York, 1987.
- [4] M. S. Ghidaoui, M. Zhao, D. A. McInnis and Axworthy, D. "A review of water hammer theory and practice " *ASME*, 58(1), 49-76, 2005.
- [5] E. B. Wylie and V. L. Streeter, *Fluid transients* Corrected edition Ed., Thomson-Shore, Dexter, MI, United States of America, 1983.
- [6] D. J. Wood, S. Lingireddy, B. W. Karney, P. F. Boulous, and D. L. Mcpherson, "Numerical methods for modeling transient flow." *American Water Works Association (AWWA)*, 97:7, 104-114, 2005.
- [7] J. A. Twyman, *Decoupled Hybrid methods for unsteady flow analysis in pipe networks*, Lo Arcaya, Santiago de Chile, 2004.
- [8] Nabi, G., Habib-ur-Rehman, Kashif, M., and Tareq, M. (2011). "Hydraulic transient analysis of surge tanks: case study of Satpara and GolenGol Hydropower projects in Pakistan " *Pak. J. Engg. & Apple Sci*, 8, 34-48.
- [9] V. L. Streeter and E. B. Wylie, "Waterhammer and surge control." *Annual review fluid mechanics*, 1974:6, 57-73, 1973.
- [10] T. Tezkan, U. Gokkus and G. Siner, "Analysis of unsteady flow in complex pipe system by the method of characteristics. " *Mechanical and computational applications*, 3:1, 27-35, 1998.
- [11] B. W. Karney and D. McInnis, "Efficient calculation of transient flow in simple pipe networks." *Hydraulic Engineering*, 118:7, 1014-1030, 1992.
- [12] A. Kodura and K. Weinerowska, "Some aspects of physical and numerical modeling of water hammer in pipelines." In: *International Symposium on Water Management and Hydraulic Engineering*, Ottenstein-Austria 125-133, 2005.
- [13] B. W. Karney, and D. McInnis, "Transient analysis of water distribution systems." *American Water Works Association (AWWA)*, 62-70, 1990.
- [14] K. Sirvole, "Transient analysis in piping networks," Virginia Polytechnic Institute and State University, Blacksburg, Virginia, 2007.
- [15] B. S. Jung, B. W. Karney, P. F. Boulous and D. J. Wood, "The need for comprehensive transient analysis of distribution systems." *American Water Works Association (AWWA)*, 99:1, 112-123, 2007.
- [16] S. H. Aljanabi, "Numerical modeling of transient flow in long oil pipeline system." *Engineering & Technology*, 28:16, 5346-5357, 2010.
- [17] M. H. Chaudhry, *Applied hydraulic transient*, First edition Ed., Van Nostrand Reinhold Company Inc, New York, 1979.
- [18] B. E. Larock, R. W. Jeppson and G. Z. Watters, *Hydraulics of pipeline systems*, one Ed., CRC Press LLC, Unites States of America, 2000.
- [19] G. Nabi, Habib-ur-Rehman, M. Kashif and M. Tareq, "Hydraulic transient analysis of surge tanks: case study of Satpara and GolenGol Hydropower projects in Pakistan " *Pak. J. Engg. & Apple Sci*, 8, 34-48, 2011.
- [20] P. F. Boulous, B. W. Karney, D. J. Wood, and S. Lingireddy, "Hydraulic Transient Guidelines for Protecting Water Distribution Systems" *American Water Works Association (AWWA)*, 97:5, 111-124, 2005.