

Power System Damping Using Hierarchical Fuzzy Multi- Input PSS and Communication Lines Active Power Deviations Input and SVC

Mohammad Hasan Raouf, Ahmad Rouhani, Mohammad Abedini, Ebrahim Rasooli Anarmarzi

Abstract—In this paper the application of a hierarchical fuzzy system (HFS) based on MPSS and SVC in multi-machine environment is studied. Also the effect of communication lines active power variance signal between two $\Delta P_{Tie-line}$ regions, as one of the inputs of hierarchical fuzzy multi-input PSS and SVC (HFMPSS & SVC), on the increase of low frequency oscillation damping is examined. In the MPSS, to have better efficiency an auxiliary signal of reactive power deviation (ΔQ) is added with $\Delta P + \Delta \omega$ input type PSS. The number of rules grows exponentially with the number of variables in a classic fuzzy system. To reduce the number of rules the HFS consists of a number of low-dimensional fuzzy systems in a hierarchical structure. Phasor model of SVC is described and used in this paper. The performances of MPSS and $\Delta P_{Tie-line}$ based HFMPSS and also the proposed method in damping inter-area mode of oscillation are examined in response to disturbances. The efficiency of the proposed model is examined by simulating a four-machine power system. Results show that the proposed method is performing satisfactorily within the whole range of disturbances and reduces the cost of system.

Keywords—Communication lines active power variance signal, Hierarchical fuzzy system (HFS), Multi-input power system stabilizer (MPSS), Static VAR compensator (SVC).

I. INTRODUCTION

ONE of the problems that electrical engineers are always facing with them is Power System oscillations. Power system stability is essential to reliable operation of power system. Power System Stabilizer is developed to improve damping of low frequency oscillations in Power System [1].

In the last two decades, several types of PSS are investigated. Classic PSS is one of the earliest types of methods to increase damping of low frequency oscillations. PSS is used based on different control methods in power systems, such as neural networks [2], fuzzy control [3], and genetic algorithm [4]. Also, FACTS devices are used for damping the low frequency oscillations [5]. MPSS has been developed to improve damping of low frequency power swing by adding reactive power signal to Classic PSS input [6], [7].

M. H. Raouf and A. Rouhani are with the Young Researchers and Elite Club, Beyza Branch, Islamic Azad University, Beyza, Iran (e-mail: raouf2892@gmail.com rouhani@biau.ac.ir).

M. Abedini is with the Department of Electrical Engineering, Faculty of Engineering of Bu Ali Sina, Hamadan, Iran (e-mail: M_Abedini_Dr@yahoo.com).

E. Rasooli Anarmarzi is with the Department of Electrical Engineering, University of Tabriz, Tabriz, Iran (e-mail: ebrahim.rasooly@gmail.com).

The dimension of the system variables is one of the most important problems in a classic fuzzy system. If there are k input variables and c membership functions are defined for each of these, then the number of rules in the fuzzy system is c^k . In fact the number of rules grows exponentially with the number of variables in a standard fuzzy system. The hierarchical fuzzy system (HFS) structure is used to solve this problem [8]-[11].

Static Var Compensator (SVC) is one of the most common Flexible AC Transmission Systems (FACTS) devices that behave like a variable shunt susceptance. SVC devices are used to improve voltage and reactive power conditions in power systems and also can be used as a reactive power supply. In fact SVC can consume the spare inductive reactive power from the grid or supply capacitive reactive power to the grid. In previous work the performances of CPSS&SVC and MPSS&SVC and also HFMPSS&SVC under similar transient conditions were studied [13].

In this paper, the effect of communication lines active power variance signal between two $\Delta P_{Tie-line}$ regions, as one of the inputs of HFMPSS & SVC on the increase of low frequency oscillation damping of the system and also the increase of capability of the system by variation in its working situation is studied. The effectiveness of the proposed method is then demonstrated through digital computer simulation. Also, its performance is compared with a MPSS and $\Delta P_{Tie-line}$ based HFMPSS. It is shown that, by application of proposed method, good dynamic performance can be obtained. MATLAB/SIMULINK is used for simulation.

II. EFFECT OF REACTIVE POWER DEVIATIONS AUXILIARY SIGNAL ON THE POWER SYSTEM STABILIZER

Stabilizers based on Δw signal are used widely in different types of power plants, especially water units, since middle of 1960s. This kind of stabilizer damps rotor oscillations, but it may cause instability in torsional modes. Therefore, the main problem of this stabilizer is using the torsional filter. Also in order to weakening the torsional components of the stabilizer signal, the filter causes some phase lag in low frequencies. The occurred phase lag has a destroying effect on the stability of exciting mode and limits the total efficiency of stabilizer on the damping of system oscillation [13]. $\Delta P + \Delta W$ stabilizer is used to solve the above problem. Torsional components in the integral of signal ΔP are weakened and therefore, there is no need to torsional filter [9]. But by increasing δ , sensitivity of

ΔP to oscillation is reduced. Thus, the efficiency of $\Delta P + \Delta W$ stabilizer is decreased. A system contain of a synchronies generator connected to an infinite bus by X_e impedance is shown in Fig. 1.

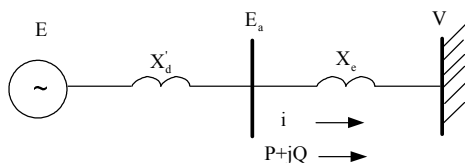

Fig. 1 Model of machine connection to the infinite bus system where X'_d transient reactance of machine, V system voltage, E generator voltage and E_a generator bus voltage

$$P = \frac{EV \sin \delta}{X'_d + X_e} \quad (1)$$

$$Q = \frac{E(E - V \cos \delta)}{(X'_d + X_e)} \quad (2)$$

By linearizing the above equations around working point $\delta = \delta_0$, one has:

$$\Delta P = \frac{\partial P}{\partial \delta} \Delta \delta = \frac{EV}{X'_d + X_e} \cos \delta_0 (\Delta \delta) \quad (3)$$

$$\Delta Q = \frac{\partial Q}{\partial \delta} \Delta \delta = \frac{EV}{X'_d + X_e} \sin \delta_0 (\Delta \delta) \quad (4)$$

Equations (3) and (4) are plotted in Fig. 2.

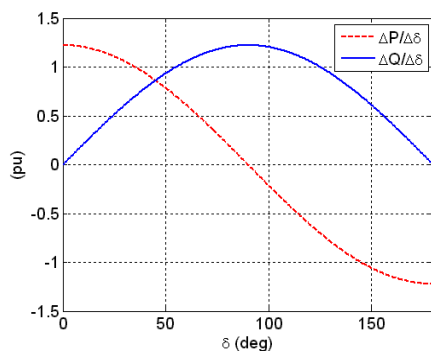

Fig. 2 Variations of $\frac{\Delta P}{\Delta \delta}$ and $\frac{\Delta Q}{\Delta \delta}$ vs. δ

As it can be seen in Fig. 2 by increasing δ ; ΔP and ΔQ decreases and increases respectively in the range of 0-90 degrees. Therefore, sensitivity of ΔP to rotor angle variation decreases and sensitivity of reactive power to rotor angle variation increases. Since ΔP is the signal input of stabilizer type $\Delta P + \Delta W$, its sensitivity decrease reduces stabilizer efficiency. To compensate this defect and increase the stabilizer efficiency, an auxiliary signal of reactive power deviation (ΔQ) is used. It is expected that the reactive power

input of the MPSS is effective to damp the lower frequency power swing. Thus, in angles $45^\circ \leq \delta$, increase of reactive power sensitivity to δ variation can be used to increase the efficiency of PSS.

III. MULTI-INPUT STABILIZER STRUCTURE

MPSS is introduced to increase robustness for changing system conditions and to increase damping of power low frequency oscillations in power system. In conventional PSS, ΔP and ΔW signals are used as input. In MPSS, reactive power deviation (ΔQ) is an additional signal added to conventional PSS input. MPSS structure is shown in Fig 3. Two lead-lag compensators are used for every input signal [14]. But determining the compensator parameter is difficult.

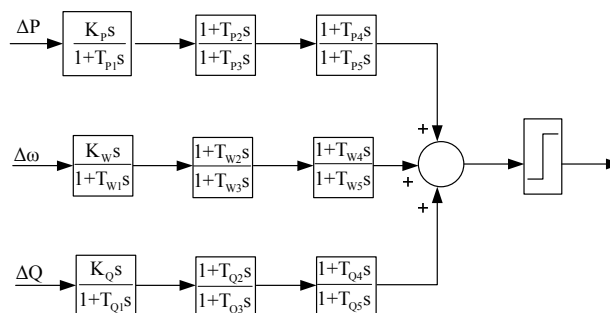

Fig. 3 Configuration of the MPSS

In this paper, the proposed $\Delta P_{Tic-line}$ based HFMPSS & SVC is used. In this type of stabilizer, hierarchical fuzzy controller is used instead of lead-lag compensators and static VAR compensator that have better efficiency than multi-input power system stabilizer (MPSS).

IV. HIERARCHICAL FUZZY CONTROLLER

Fuzzy system does not require mathematical model. It can cover a wide range of operating conditions and it is attractive for nonlinear systems applications [15].

The aim of fuzzy control systems is to reduce the number of iterations and decrease computation time by using fuzzy logic. [16], [17].

In a standard fuzzy logic system the total number of involved rules grows exponentially whereas it is only linearly in a hierarchical form. In fact in a hierarchical fuzzy system the number of rules is altered by decomposing the fuzzy system to a set of simpler fuzzy subsystem connected in a hierarchical manner [18] as shown in Fig. 4.

The hierarchical fuzzy logic controller (HFCL) structure consists of a number of low-dimensional fuzzy systems in a hierarchical form. The most influential system variables are chosen in the first level, the next most important variables are chosen in the second level, and so on [19].

In fact, in the hierarchical fuzzy structure, each input variable is used in a two-input FLC and the input variables are put into a collection of low-dimensional fuzzy controller structure instead of single high-dimensional fuzzy structure

units. It could be found that the total number of rules is greatly reduced under hierarchical fuzzy logic controller structure [20].

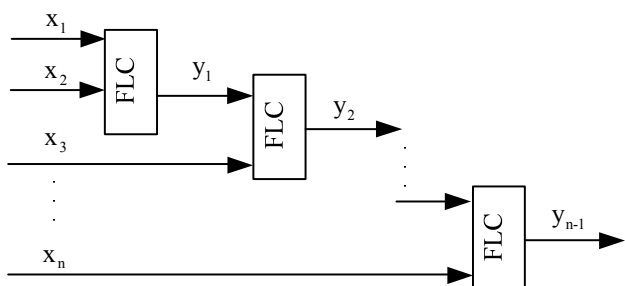

Fig. 4 Hierarchical FLC structural representation

V. HIERARCHICAL FUZZY MULTI-INPUT POWER SYSTEM STABILIZER

Three input variables (ΔP , $\Delta\omega$, ΔQ) are used as inputs of the HFMPSS. A fuzzy set with seven elements are defined as Table I. They are PB (Positive Big), PM (Positive Medium), PS (Positive Small), ZE (Zero), NS (Negative Small), NM (Negative Medium) and NB (Negative Big).

In this paper, Hierarchical control structure is constructed by two fuzzy subsystems where each subsystem has only two inputs. The ΔQ and $\Delta\omega$ are the input variables of the first subsystem. The output of the first subsystem and the variable ΔP are the input variables of second subsystem as shown in Fig. 5.

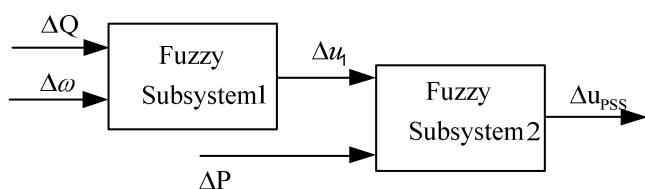

Fig. 5 Detailed HFC structure

The triangular membership functions are used to define the degree of membership as shown in Fig. 6. Mamdani-minimum inference system and centroid defuzzification are used in this paper to design the fuzzy system. The adopted fuzzy rules are reported in Tables I and II.

The triangular membership functions are normalized using the following factors:

$K_w = 34.33$, is the Speed change input coefficient;

$K_Q = 0.0592$, is the Reactive power change input coefficient;

$K_p = 0.53$, is the Active power change input coefficient;

$K_{U1} = 1$, is the Output coefficient (in subsystem 1); and

$K_{UPSS} = 1$, is the Output coefficient (in subsystem 2).

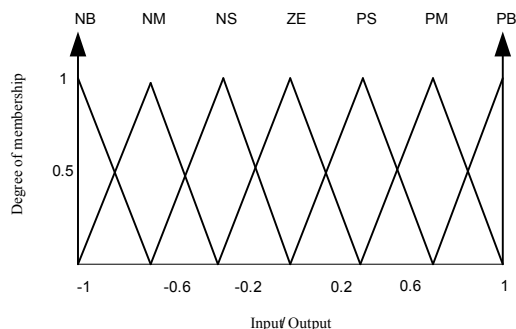

Fig. 6 Membership Function Scaled from -1 to 1

TABLE I
 RULES TABLE OF $\Delta\Omega$

$\Delta\omega$ \ ΔQ	NB	NM	NS	ZE	PS	PM	PB
NB	NB	NB	NB	NB	NM	PS	ZE
NM	NB	NM	NM	NM	NS	ZE	PS
NS	NB	NM	NS	NS	ZE	PS	PM
ZE	NB	NM	NS	ZE	PS	PM	PB
PS	NM	NS	ZE	PS	PS	PM	PB
PM	NS	ZE	PS	PM	PM	PB	PB
PB	ZE	PS	PM	PB	PB	PB	PB

TABLE II
 RULES TABLE OF ΔP

ΔP \ Δu_1	NB	NM	NS	ZE	PS	PM	PB
NB	NB	NB	NB	NM	NM	NS	ZE
NM	NB	NM	NM	NM	NS	ZE	PS
NS	NB	NM	NS	NS	ZE	PS	PM
ZE	NM	NM	NS	ZE	PS	PM	PM
PS	NM	NS	ZE	PS	PS	PM	PB
PM	NS	ZE	PS	PM	PM	PM	PB
PB	ZE	PS	PM	PB	PB	PB	PB

VI. STATIC VAR COMPENSATOR (SVC)

One of the SVC main advantages is to compensate the reactive power [12]. Also this device can be used to regulate the voltage at a chosen bus by suitable control of its equivalent reactance. To study the transient stability in this paper, a fuzzy model of SVC is used to regulate the busbar voltage. Since the important task of SVC is to increase transmission capacity as result of power oscillation damping the auxiliary control signal can be used in fuzzy model of SVC [21]. The proposed fuzzy model for SVC devices is shown in Fig. 7.

The slope or droop of the V-I characteristic can be calculated as:

$$X_{sl} = \frac{\Delta V}{\Delta I} \quad (5)$$

where ΔV is the ratio of change in voltage magnitude and ΔI is

the ratio of change in current magnitude.

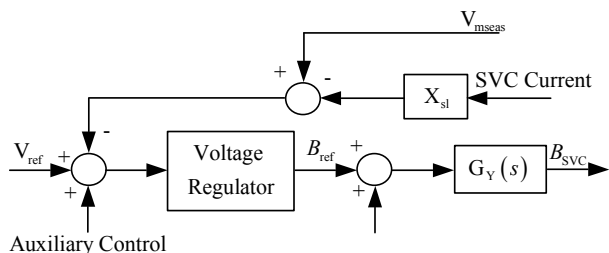

Fig. 7 SVC Controller

The common value of slop is 3-5% [21]. The SVC current can be calculated by multiplying B_{ref} and V_{meas} . The proposed fuzzy model in this paper does not consist of any thyristor, synchronizing system or Gate Pulse Generator (GPG). The below transfer function for the proposed fuzzy model can also be obtained as [20]:

$$G_Y(s) = \frac{e^{-sT_d}}{1 + sT_b} \quad (6)$$

In this transfer function T_d is the thyristor dead time, that is equal to one-twelfth cycle time, and T_b is the thyristor firing-delay time caused by sequential switching of thyristors, that is approximately equal to one-quarter cycle time.

VII. SYSTEM MODEL

A. Power System Model

To simulating by the proposed idea in this paper, the Kundur's Two-area Test System having 4 power plants and 11-bus is used [14]. Since the power system stability must be existed under all sequences after faults, the transmission line is shunt compensated at its center by a 1Mvar SVC. This system is shown in Fig. 8.

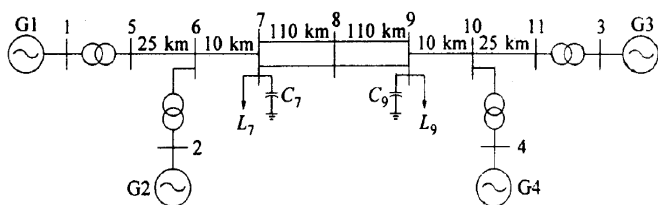

Fig. 8 Kundur's Two-area Test System

B. AVR and PSS

The excitation system is a dc exciter similar to described in [22] without the saturation function. The basic components that form the excitation system block are the voltage regulator and the exciter.

The conventional power system stabilizer (CPSS) method is a common approach to improve damping of low frequency oscillations but in a multi-machine power system, CPSS components need to be optimized to coordinate with other

machines and devices such as FACTS devices. CPSS is modeled by the nonlinear system as shown in Fig. 9. The optimization method of this CPSS is same as that of [14]. The values of $\Delta\omega$ are given in Table V (see Appendix: Fuzzy Controller Data).

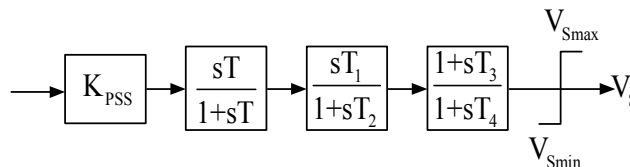

Fig. 9 Block diagram of the PSS

VIII. RESULTS

To evaluating the performance of the proposed method, two kinds of disturbances, small and large signal, are examined. The results are described as follows:

A. Small Disturbance

To study the efficiency of the proposed method in the case of small signal disturbance, 5% disturbance is applied to the reference voltage of machine 1 with both parallel transmission lines connected. The simulation results for rotor angle, terminal voltage and transmitted active power from area 1 to area 2 are shown in Figs. 10 to 12.

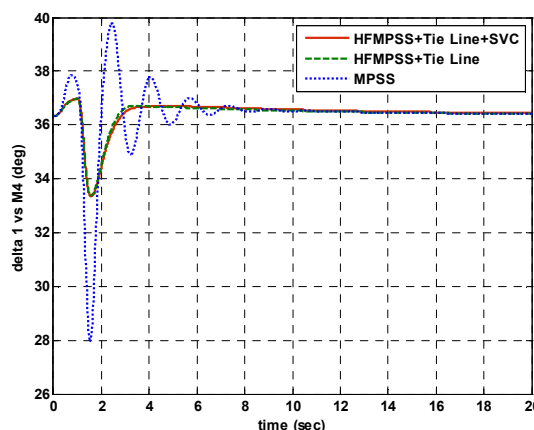

Fig. 10 Rotor angle deviation of machine 1 w.r.t. machine 4

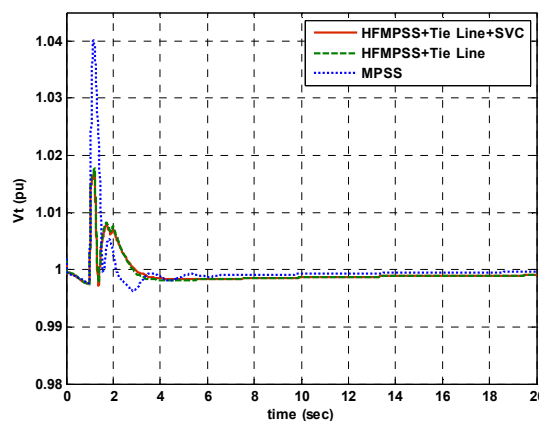

Fig. 11 Terminal voltage of machine 1

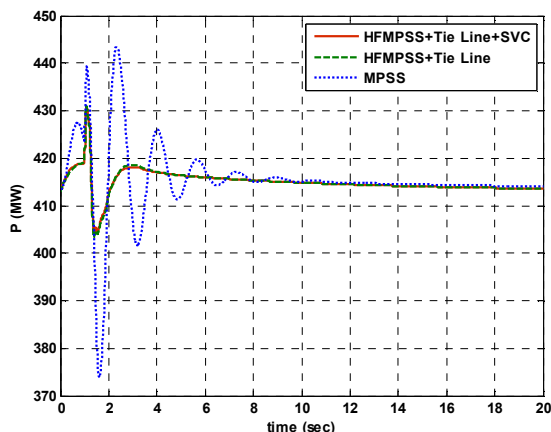

Fig. 12 Active power from area 1 to area 2

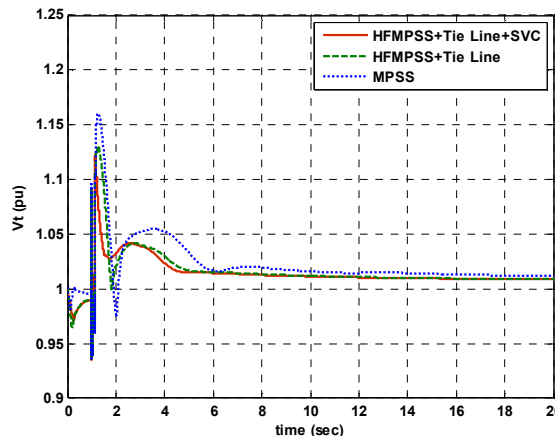

Fig. 14 Terminal voltage of machine 1

Open Science Index, Electrical and Computer Engineering Vol:7, No:12, 2013 publications.waset.org/9997269.pdf

These simulation results show the superiority of the proposed method (HFMPSS+Tie Line+SVC) compared to MPSS. Figs. 10-12 show that the proposed method and $\Delta P_{Tie-line}$ based HFMPSS (HFMPSS+Tie Line) have almost the same overshoot and settling time. It can be seen from Figs. 10-12 that the proposed design may rapidly damp out oscillation.

B. Large Disturbance

In this section to study the efficiency of the proposed method, first three-phase to earth error is created at the middle of one of the Tie-Lines. The performances of MPSS and HFMPSS+Tie Line and the proposed method under these transient conditions are shown in Figs. 13-15. As seen, the proposed method in this paper has better damping effectiveness and control performance in comparison with MPSS and HFMPSS+Tie Line in terms of settling times and damping effects.

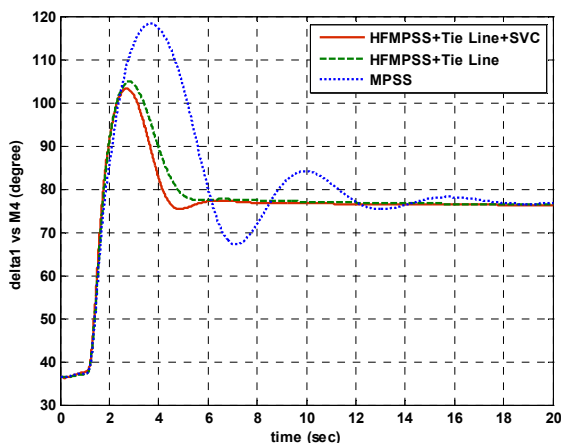

Fig. 13 Rotor angle deviation of machine 1 w.r.t. machine 4

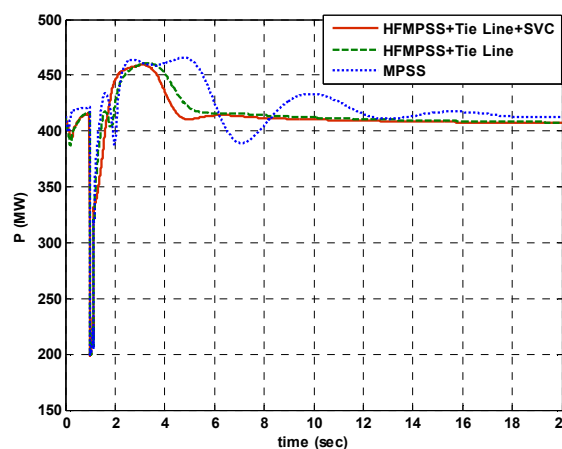

Fig. 15 Active power from area 1 to area 2

IX. CONCLUSION

In this paper, the proposed design is studied for test system is given in [14]. MPSS increases the system stability in the low frequency oscillation for rotor angles $45^\circ \leq \delta$. In a standard fuzzy logic system the total number of rules grows exponentially whereas it is only linearly in a hierarchical structure. SVC is one of the most effective devices which are used primarily for the purpose of voltage and reactive power control. The objective of this paper is to increase damping of power system oscillations by using $\Delta P_{Tie-line}$ based HFMPSS&SVC. Active power deviation input of communication lines between two regions ($\Delta P_{Tie-line}$) is used to reduce cost of the system. Simulation results illustrate the better efficiency of proposed method to damp low frequency power oscillations compared to the MPSS, $\Delta P_{Tie-line}$ based HFMPSS and also the mentioned design in [23], which shows clearly the robustness of the proposed strategy in multi-input power system stability without changing any parameters.

APPENDIX
TABLE III
GENERATOR DATA

Param.	No. of Gen	G1,G2	G3,G4
	Type	Steam	Steam
Capacity (MVA)		900	900
Voltage (kV)		20	20
Xd (pu)		1.8	1.8
X'd (pu)		0.3	0.3
X''d (pu)		0.25	0.25
Xq (pu)		1.7	1.7
X'q (pu)		0.55	0.55
X''q (pu)		0.25	0.25
H (sec)		6.5	6.175
T'd0 (sec)		8	8
T''d0 (sec)		0.03	0.03
T'q0 (sec)		0.4	0.4
T''q0 (sec)		0.05	0.05

TABLE IV
LOAD DATA

Param.	P ₁ (MW)	Q ₁ (Mvar)	Q _c (Mvar)
No. of Bus			
7	967	100	387
9	1767	100	537

TABLE V
FUZZY CONTROLLER DATA

Input	Δω	ΔP	ΔQ
Parameter			
K _{PSS}	20	0.5	0.01
T (sec)	10	1	1
T ₁ (sec)	3	0.06	0.06
T ₂ (sec)	5.4	1	1
T ₃ (sec)	3	0	0
T ₄ (sec)	5.4	0	0

Transmission Lines Data:

$$V_{base} = 230kV, S_{base} = 100MVA$$

$$R = 0.0001 \text{ pu/km}, X = 0.001 \text{ pu/km}, B_C = 0.00175 \text{ pu/km}$$

AVR Data:

$$K_A = 200, T_A = 0.001 \text{ sec}$$

REFERENCES

[1] P. M. Anderson, A. A. Fouad, *Power system control and stability*, Iowa State University Press, Ames, Iowa, 1977.
 [2] P. Tulpule and A. Feliachi, "Online learning neural network based PSS with adaptive training parameters", *IEEE*, 2007.
 [3] A. R. Roosta; H. Khorsand; M. Nayeripour; "Design and analysis of fuzzy power system stabilizer", *IEEE PES*, 2010.
 [4] A. Al-Hinai, "Dynamic Stability Enhancement using Genetic Algorithm Power System Stabilizer", *International conference on Power system technology*, IEEE 2010.
 [5] S. Panda and N. P. Padhy, "Comparison of particle swarm optimization and genetic algorithm for FACTS-based controller design", *Elsevier on Soft Computing*, 2008.
 [6] Y. Kitauchi, H. Taniguchi, T. Shirasaki, Y. Ichikawa, M. Amano, M. Banjo, "Experimental verification of multi-input PSS with reactive

power input for damping low frequency power swing", *IEEE Trans. Energy Convers.* Vol. 14, No. 4, pp. 1124-1130, Dec 1999.
 [7] M. Ozaki, M. Mizutani, "A design method of multi-input PSS using high speed genetic algorithm", *IEEE. Power System Technology*, Vol. 3, pp. 1287-1291, 2000.
 [8] Zhen. Yu, Arthur. Dexter, "Hierarchical fuzzy control of low-energy building systems", *Elsevier, Solar Energy*, Vol. 84, Issue 4, pp. 538-548, April 2010.
 [9] T. Hussein, A. L. Elshafei, A. Bahgat, "Design of a hierarchical fuzzy logic PSS for a multi-machine power system", *IEEE, Control & Automation*, pp. 1-6, 2007.
 [10] Li. Ling-Juan, Liang. Yu-Long, "A hierarchical fuzzy clustering algorithm", *IEEE, International Conference on computer Application and System Modeling (ICCSM)*, Vol. 12, pp. 248-251, 2010.
 [11] C. France, L. Richard, "Designing a hierarchical fuzzy logic controller using the differential evolution approach", *Elsevier, Applied Soft Computing*, Vol. 7, pp. 481-491, 2007.
 [12] Mustafa, N. Magaji, "Design of Power Oscillation Damping Controller for SVC Device", *Proc. of the 2nd IEEE International Conference on Power and Energy (PECon 08)*, Dec. 2008.
 [13] M. H. Raouf, E. Rasooli Anarmarzi, H. Iesani, J. Olamaei, "Power System Damping Using Hierarchical Fuzzy Multi- Input Power System Stabilizer and Static VAR Compensator", *International Journal of Electrical and Electronics Engineering*, Vol. 14, No.4, pp. 117-123, 2011.
 [14] P. Kundur, *Power system stability and control*, McGraw-Hill, New York, 1994.
 [15] D. E. Kvasov, D. Menniti, A. Pinnarell, Y.D. Sergeyev, N. Sorrentino, "Tuning fuzzy power-system stabilizers in multi-machine systems by global optimization algorithms based on efficient domain partitions", *Elsevier on Electrical Power Systems Research*, pp. 1217-1229, January 2008.
 [16] G. Hyun Hwang, Dong-Wan Kim, Jae-Hyun Lee, Young-Joo An, "Design of fuzzy power system stabilizer using adaptive evolutionary algorithm", *Elsevier on Engineering Applications of Artificial Intelligence*, pp. 86-96, 2008.
 [17] C. W. Tao, J. S. Taur, C. M. Wang, U. S. Chen, "Fuzzy hierarchical swing-up and sliding position controller for the inverted pendulum-cart system", *Elsevier on Fuzzy Sets and Systems*, pp. 1-22, February 2008.
 [18] H. A. Toliyat, J. Sadeh, R. Ghazi, "Design of augmented fuzzy logic power system stabilizers to enhance power systems stability", *IEEE Trans. Energy Convers.* Vol. 11, pp. 97-103, March 1996.
 [19] L. Wang, "Analysis and design of hierarchical fuzzy systems", *IEEE Trans. Fuzzy System*, Vol. 7, pp. 617-624, Oct. 1999.
 [20] H. Li, S. Tso, "Higher order fuzzy control structure for higher order or time-delay systems", *IEEE Trans. Fuzzy System*, Vol. 7, pp. 540-552, Oct. 1999.
 [21] Narain G. Hingorani, Laszlo Gyugyi, *Understanding FACTS, Concepts and Technology of Flexible AC Transmission Systems*, New York: IEEE Press.
 [22] Recommended practice for excitation system models for power system stability studies, *IEEE standard 421.5-1992*; August, 1992.
 [23] P. Mitra, S. Chowdhury, S. P. Chowdhury, S. K. Pal, R. N. Lahiri, Y. H. Song, "Performance of A Fuzzy Power System Stabilizer With Tie Line Active Power Deviation Feedback", *IEEE PSCE*, pp. 884-889, Oct. 2006.