

Process Parameter Optimization in Resistance Spot Welding of Dissimilar Thickness Materials

Pradeep M., N. S. Mahesh, Raja Hussain

Abstract—Resistance spot welding (RSW) has been used widely to join sheet metals. It has been a challenge to get required weld quality in spot welding of dissimilar thickness materials. Weld parameters are not generally available in standards for thickness beyond 4mm. This paper presents the welding process design and parameter optimization of RSW used in joining of low carbon steel sheet of thickness 0.8 mm and metal strips of cross section 10 x 5mm for electrical motor applications. Taguchi quality design was adopted for weld current and time optimization using L9 orthogonal array. Optimum process parameters (current- 3.5kA and time- 10 cycles) were obtained from the Taguchi analysis and shear test results. Confirmation experiment result revealed that the weld quality was within acceptable interval. Further, numerical simulation of RSW process was carried out with selected weld parameters to quantify the temperature at faying surface and check for formation of appropriate nugget. The nugget geometry measured after peel test and predicted from numerical validation method were similar and in accordance with the standards.

Keywords—Resistance spot welding, dissimilar thickness, weld parameters, Taguchi method, numerical modeling.

I. INTRODUCTION

RESISTANCE spot welding joining process is generally used for fabricating sheet metal assemblies such as automobile panels, truck cabins, rail vehicles and home applications due to its advantages in welding efficiency and suitability for mechanization [1]. Spot welding is the resistance welding processes in which coalescence of metal is produced at the faying surface by the heat generated at the joint because of contact resistance to the flow of electric current. Force is always applied before, during and after the application of current to prevent arcing at the faying surfaces and to forge the weld metal during post heating. The process is completed within a specified cycle time. Generally, melting occurs at the faying surface during welding [2]. Selection of appropriate weld parameters such as current and time is done by trial and error methods. The current and time ranges are well documented for typical sheet thicknesses. However, RSW for dissimilar thickness requires additional care. The present study was carried out to join low carbon sheet of 0.8mm with a strip of 10mm overall thickness and 5mm width.

Pradeep M., PG Scholar, is with the GSS Institute of Technology, Bengaluru, Karnataka, India (e-mail: pradeepmahaling@gmail.com)

Dr. N.S. Mahesh, Professor and Head, is with the Dept of Mechanical and Manufacturing Engineering, MSRSAS, Bengaluru, Karnataka, India (e-mail: nsm@msrsas.org).

Raja Hussain, Asst. Professor, is with the Dept of Mechanical and Manufacturing Engineering, MSRSAS, Bengaluru, Karnataka, India (e-mail: rajahussain@msrsas.org).

II. EXPERIMENTAL DETAILS

A. Materials

Low carbon steel sheet having chemical composition of (w_i %) 0.101 C, 0.332 Mn, 0.011 S, 0.019 P, (balance) Fe was used. Electrode used was Copper Chromium alloy having diameter of 10mm towards vent finger and that of 7 mm towards base plate. Fig. 1 shows the vent finger of 10 mm thickness and base plate of 0.8 mm thickness.

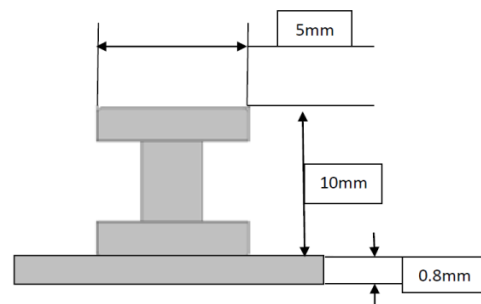

Fig. 1 10 x 5mm Vent Finger with 0.8mm thick base plate

B. Process Parameters

Input parameters selected were welding current and weld time because these are the two major parameters which affect the weld quality. The significant levels of welding current and weld time were selected based on trial experiments. The welding current levels mentioned in Table I are corresponding to the 3, 4 & 5 taping numbers out of 7 tapings. Weld time is expressed in terms of cycles, because the electric power supply is 50 Hz alternating current. Output parameter predicting strength of weld joint is shear strength. The input parameters are shown in Table I.

TABLE I
PROCESS PARAMETERS WITH THEIR VALUES AT THREE LEVELS

Level	Welding current [kA]	Weld time [Cycle]
1	2.1	10
2	3.5	15
3	5.3	20

C. Selection of Orthogonal Array

Any nonlinear relationship among the process parameters, if it exists can only be revealed if more than two levels of parameters are considered. Thus each parameter was selected at three levels. According to Taguchi method based on robust design, a L9 orthogonal array was employed for the experimentation [3].

D. Experimentation

Total 9 runs of experiments based on randomized OA were done. Current and weld time were varied as per values for each level mentioned in Table I. RSW weld trials were taken for each setting and shear strength (response) test was conducted as per standards. The experimental data is given in Table II.

TABLE II
 EXPERIMENTAL DATA FOR COMPRESSIVE SHEAR STRENGTH

Test No.	Current (kA)	Time (Cycles)	Shear Strength (kN)	S/N ratio for shear strength in dB
1	2.1	10	1.98	3.04577
2	2.1	15	1.20	4.45433
3	2.1	20	1.89	1.93820
4	3.5	10	2.21	5.93330
5	3.5	15	1.56	1.58362
6	3.5	20	1.48	5.52924
7	5.3	10	1.42	6.88785
8	5.3	15	1.67	3.86249
9	5.3	20	1.25	3.40523

In Table II, it can be observed that test number 4 has yielded higher shear strength of 2.21 kN corresponding to the 3.5 kA current and 10 cycles time. Also, it is observed that shear strength values are low corresponding to the higher current specimen when compared to that of lower current. This is because, higher current will burn the more region of base plate due to which the joint fails at relatively lesser load.

E. Results of Experimentation

Fig. 2 shows the S/N ratio graph where the horizontal line is the value of the total mean of the S/N ratio. Basically, the larger the S/N ratio, the better is the quality characteristic for the shear strength. From Table III, it can be inferred that weld time is the major factor in spot welding when compared with the welding current. The optimized process parameters are current 3.5 kA and time 10 cycles.

TABLE III
 RESPONSE TABLE FOR S/N RATIO AND SHEAR STRENGTH

Level	Current	Time
1	4.349	5.289
2	4.719	3.3
3	3.146	3.624
Delta	0.303	0.393
Rank	2	1

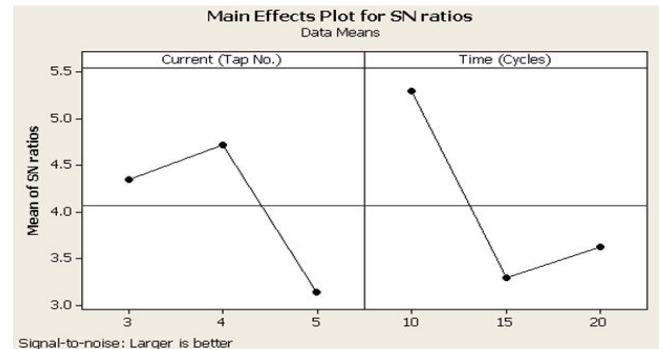

Fig. 2 Mean of S/N ratio in Taguchi analysis for 10 x 5mm

III. NUMERICAL VALIDATION

The temperature at faying surface and appropriate nugget formation decides the strength of resistance spot weld. The measurement of temperature at faying surface and visualization of nugget formation is practically very difficult during RSW process. Finite element approach was followed for carrying out simulation of RSW process. The aim of simulation experiment was to quantify the temperature at faying surface and ensure formation of appropriate nugget with optimized set of input parameters. The input parameters selected for simulation trials have been obtained from Taguchi analysis carried out in the present study.

A. FEA Model and Mesh

Process modeling of RSW was carried out using commercially available FEA tool, ANSYS. The electrodes and work pieces are meshed using three elements: PLANE223, CONTA175, and TARGE169. The element PLANE223 with structural-thermoelectric capabilities has eight nodes with up to four degrees of freedom per node [4]. It has UX, UY, TEMP and VOLT degrees of freedom. The other elements are contact elements consisting of contact pair of CONTA175 and TARGE169. Contact occurs when the element surface penetrates one of the target segment elements (TARGE169) on a specified target surface. Fig. 3 shows the meshed elements in which centre portion is fine meshed when compared to outer region because that is the region where heat generation and temperature distribution takes place [5].

B. Material Models and Welding Conditions

Material properties as a function of temperature were considered for copper electrode and mild steel sheets. The properties assigned were thermal conductivity, resistivity, Young's modulus, coefficient of thermal expansion, and specific heat [6]. The input density value of mild steel was 7850 kg/m³ and that of copper was 8960 kg/m³. 50 Hz sine wave AC has been used as input current for simulation. The current is imposed as an electric load on the top surface of upper electrode. A force of 2000 N was applied on the upper electrode which was obtained by pneumatic pressure applied on the sheets. This force was based on available RSW machine specification used for experimental validation. Parameter values obtained through Taguchi analysis (3.5kA

alternating current for 200ms) were applied on the work pieces.

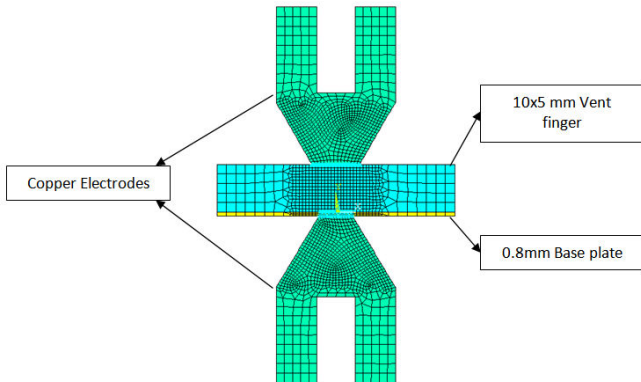

Fig. 3 FEA model of spot welding scheme for 10x5mm vent finger

C. Boundary Conditions

The electrodes and work pieces were constrained in X and Y directions. A voltage difference was applied across the top face of upper electrode and bottom face of lower electrode. The convection coefficient of air (21 W/m²K) was applied on faces of electrode and sheet which were open to ambient conditions. The convection coefficient of water (300 W/m²K) was applied on the inner faces of electrodes which were in contact with the circulating cooling water with initial temperature of 293 K. Electric potential of 3.4V was applied on top face of top electrode and zero volts on the bottom face of bottom electrode. Electric current of 3.5 kA for the time duration of 10 cycles was applied on the top face of upper electrode. The input current and voltage values were taken from Taguchi analysis and applied in the numerical model.

D. Results of Numerical Modeling

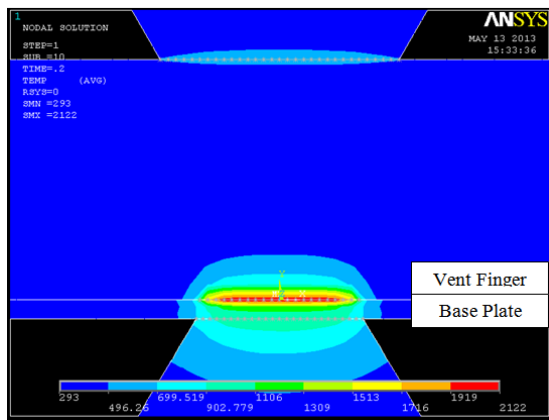

Fig. 4 Temperature distribution of 10x5mm vent finger at the beginning of nugget formation

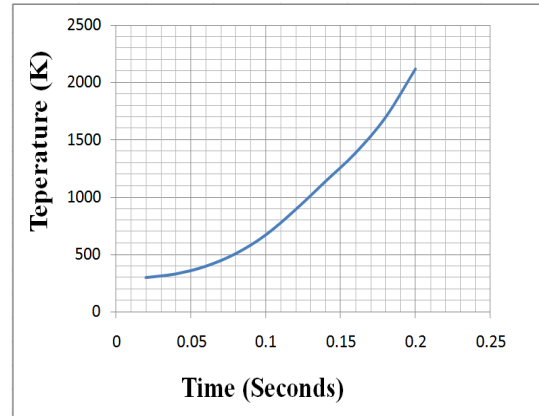

Fig. 5 Temperature increment with respect to time at Faying surface of 10x5mm vent finger

Fig. 4 shows the temperature distribution and nugget formation at the faying surface. Maximum temperature at the end of loading was 2122 K. From Fig. 5, it can be seen that maximum temperature of 2122 K was obtained at faying surface at the end of 0.2 seconds (10 cycles). As the distance increases from the faying surface, the temperature decreased gradually both in x and y direction as shown in Figs. 6 and 7.

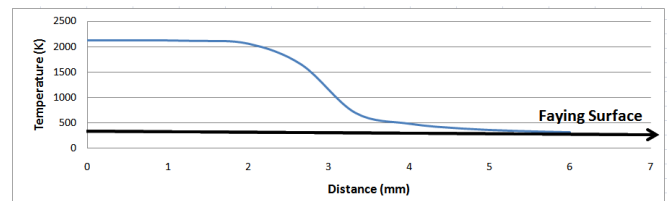

Fig. 6 Temperature distribution at faying surface of 10x5mm vent finger in horizontal (radial) direction

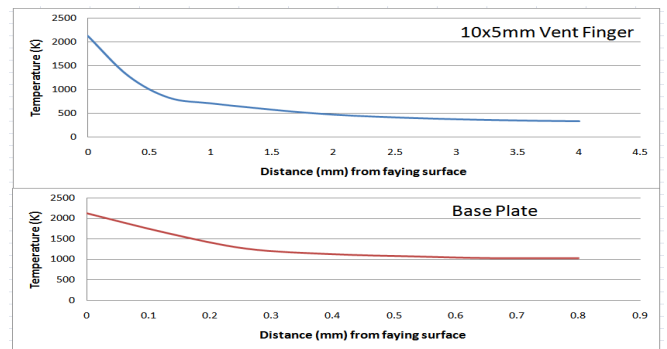

Fig. 7 Temperature distribution at faying surface of 10x5mm vent finger in vertical (thickness) direction

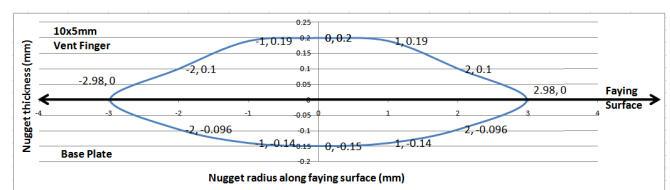

Fig. 8 Nugget geometry of 10x5mm vent finger

Temperature distribution plot obtained from ANSYS output was analyzed for visualizing the nugget geometry. It is established that, the nugget will form in the melting zone obtained during the weld cycle. The boundary of melting temperature of 1577 K in the case of mild steel sheets was located with the help of temperature distribution plot. The locus of melting temperature at different locations indicates the nugget boundary as shown in Fig. 8.

From Fig. 8, in the case of 10x5mm vent finger, nugget formed at the faying surface has a diameter of 5.96mm and thickness of 0.35mm. The nugget showed 0.2mm penetration towards vent figure and 0.15mm towards the sheet.

According to the peel test standards of spot welding process [7], minimum acceptable nugget diameter is 3mm and maximum acceptable nugget diameter must be less than the electrode diameter. In the present study, nugget diameter of 5.96mm was obtained from the numerical analysis method which lies between the acceptable interval (minimum 3mm and maximum 7mm electrode diameter).

IV. CONCLUSIONS

Optimum process parameters (current- 3.5kA and time- 10 cycles) were obtained from the Taguchi analysis based on shear test results. Confirmation experiment result revealed that the weld quality was within acceptable interval. These optimum values were used as input parameters in numerical validation. The nugget geometry measured after peel test and predicted from numerical method were similar and in accordance with the standards.

ACKNOWLEDGMENT

Authors would like to acknowledge the assistance of Mr. Gadhadar Gupta, M/s. Gupta Electricals Pvt Ltd and Mr. Nithin Venkatram, M.S. Ramaiah School of Advanced Studies, Bengaluru during the present study.

REFERENCES

- [1] Mohd Zaim Bin Din 2008. Experimental study on strength of spot welded.
- [2] Miller 2012. *Handbook for Resistance spot welding* 003 335D.
- [3] A. G. Thakur, September 2010. Application of Taguchi method to determine resistance spot welding conditions austenite stainless steel AISI 304. *Journal of Scientific and Industrial Research*, Vol. 69.
- [4] ANSYS 11.0, Documentation manual, 2010.
- [5] Thakur A.G., Rasane A.R., Nandedkar V.M., 2010. Finite Element Analysis of resistance spot welding to study nugget formation. *International Journal of Applied Engineering Research*, Dindigul, Volume 1, No 3.
- [6] C.L. Tsai, W.L. Dai, D.W. Dickinson and J.C. Papritan, December 1991. Analysis and Development of a Real- Time Control Methodology in Resistance Spot Welding. *Welding Research Supplement*, pp. 339- 351.
- [7] WE51S- Squeeze- type resistance spot weld. Copyright 1998. *Inter - Industry conference on auto collision repair*.