

Slug Initiation Evaluation in Long Horizontal Channels Experimentally

P. Adibi, M. R. Ansari, S. Jafari, B. Habibpour, E. Salimi

Abstract—In this paper, the effect of gas and liquid superficial inlet velocities and for the first time the effect of liquid holdup on slug initiation position are studied experimentally. Empirical correlations are also presented based on the obtained results. The tests are conducted for three liquid holdups in a long horizontal channel with dimensions of 5cm×10cm and 36m length. U_{sl} and U_{sg} rated as to 0.11m/s to 0.56m/s and 1.88m/s to 13m/s, respectively. The obtained results show that as $\alpha_l=0.25$, slug initiation position is increasing monotonically with U_{sl} and U_{sg} . During $\alpha_l=0.50$, slug initiation position is almost constant. For $\alpha_l=0.75$, slug initiation position is decreasing monotonically with U_{sl} and U_{sg} . In the case of equal void fraction of phases, generated slugs are weakly (low pressure). However, for the unequal void fraction of phases strong slugs (high pressure) are formed.

Keywords—Liquid holdup, Long horizontal channel, Slug initiation position, Superficial inlet velocity.

I. INTRODUCTION

INTERMITTENT or slug flow is a very common occurrence in gas-liquid two-phase flow. Usually, it is an unfavorable flow pattern since the existence of long lumps of liquid slugs that move at high speed is unfavorable to gas-liquid transportation as well as its unsteady nature, intermittency and high-pressure drop [1], [2].

For importance of oil and gas transportation in long pipelines for the exploitation of subsea reservoirs, the research on slug flow has been intensified during the last decades, as the phenomenon of slugging introduces fluctuations of an unstable nature that must be considered in the design of two-phase flow systems [3]. It is necessary to be able to predict the effects of inclination, gas density, and large pipe diameter for these pipelines [4]. The presence of slugs increases pressure drop, which leads to reduced production [5].

Slug flow is occurred in many of engineering applications such as transportation of hydrocarbons in pipelines, steam-water flow in petroleum industries, nuclear and steam power plants.

Wang et al. [6] reported that for space limitations, most experimental researches of slug flow were carried out in short pipes and for lower range of liquid and gas flow rates.

Pouyan Adibi is PhD student of Mechanical Engineering, Faculty of Mechanical Engineering, Tarbiat Modares University, Tehran, Iran (e-mail: p.adibi@modares.ac.ir).

Mohammad Reza. Ansari is Associate Professor of Mechanical Engineering, Faculty of Mechanical Engineering, Tarbiat Modares University, Tehran, Iran (corresponding author to provide phone: +98 21 82883363; fax: +98 21 88005040; e-mail: mra_1330@modares.ac.ir).

Sahar Jafari, Babak Habibpour, and Ebrahim Salimi are MSc students of Mechanical Engineering, Faculty of Mechanical Engineering, Tarbiat Modares University, Tehran, Iran (e-mail: sahar.jafari@modares.ac.ir, babak.habibpour@modares.ac.ir, ebrahim.salimi@modares.ac.ir).

Fan et al. [7] investigated slug initiation in air-water two-phase flow in a horizontal 0.095m pipeline. They concluded that slug initiation origin is dependent to superficial gas velocity as well as liquid height.

Davies [8] and Hale [9] studied slug initiation using a horizontal pipe made Perspex with 10m length and 0.074m I.D. stratified gas-liquid flow was created using a horizontal divider at inlet.

Ujang et al. [10] studied the pressure and superficial gas and liquid velocities effect on slug initiation and evolution of hydrodynamic slugs in a horizontal pipeline experimentally. They concluded that a large number of slugs were initiated within the first 3m of the test section. The frequency of slugging was not strongly affected when the system pressure was changed from 1 atmosphere, to 4.0 and 9.0 bar (a), closely similar values being obtained at the 10 downstream locations. However, higher pressure delayed the onset of slug initiation.

II. PHYSICS OF SLUG PHENOMENON

Ansari [11] stated that, as a gas flows over a smooth liquid surface, some waves with short wavelengths are generated at the interface. If there is sufficient gas velocity, then these short waves can grow in size and create a slug, which has a long wavelength. Ansari conducted experiments with slug flow in a rectangular duct with a cross section of 5x10 cm² and a length of 10m. In that study, Ansari concluded that a single slug unit consists of three primary regions, as shown in Figs. 1 and 2.

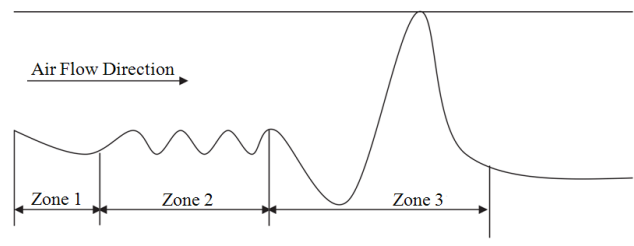

Fig. 1 Schematic of slug flow with three regions [11]



Fig. 2 Three regions of slug flow, $\alpha_l=0.75$, $U_{sl}=0.22$ m/s and $U_{sg}=5.09$ m/s, Tarbiat Modares University Multiphase Flow Lab. (MFL-TMU), Test No. 6

In the first region, the interface at the two phases is pushed down slightly because of the gas flow. In the second region, some waves are generated with short wavelengths. One of these short waves grows in the third region, which results in a

slug wave. Ansari concluded that slug creation is caused by short wavelength waves in the second region. The mechanism that causes this short wavelength growth can be explained by the Kelvin-Helmholtz instability theory (K-H).

III. EXPERIMENTAL SETUP

The experimental apparatus used in this study is shown in Fig. 3. Air and water were used in the two-phase flow study because they are non-toxic materials that are readily available.

The experiments were conducted in a horizontal Plexiglas duct with a rectangular cross-section of 5cm×10cm (equivalent hydraulic diameter of $D=6.67\text{cm}$) and a length of 36m (equivalent length 540D). The duct is transparent such that the flow regime in the duct can be easily visualized. The duct was attached to platforms that could be set to an arbitrary inclination angle.

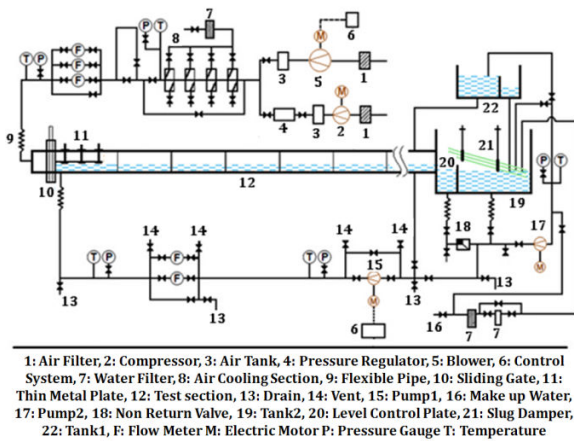

Fig. 3 Schematic of the experimental apparatus at the MFL-TMU

The system was equipped with a compressor and a blower to supply air, and two centrifugal pumps were used to supply water to the duct. Air and water were mixed at the duct inlet, and after travelling through the duct, the air and water were discharged into a tank at the end (the tank ceiling is open to ambient air) where the fluids separate from each other. Different aspects of the experimental apparatus are described in the following sections.

A. Air Supply Loop

Air was supplied to the duct using a blower. Laboratory air passed through filters entered the blower and was sent into the air tank, as shown in Fig. 4. The air temperature was controlled by a cooling system, as shown in Fig. 5. The temperature control was performed to establish thermal equilibrium of the gas and liquid in the duct. The air passed through flow meters after measuring temperature and pressure, and then the air entered the mixing portion of the duct, which was located at the beginning of the duct. An inverter was used to control the air velocity to match the required experimental conditions, as shown in Fig. 6.

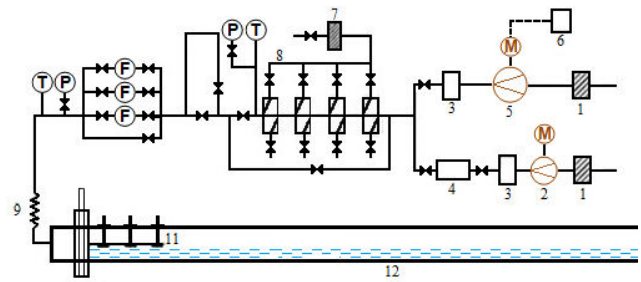

Fig. 4 Schematic of the air supply loop (MFL-TMU)

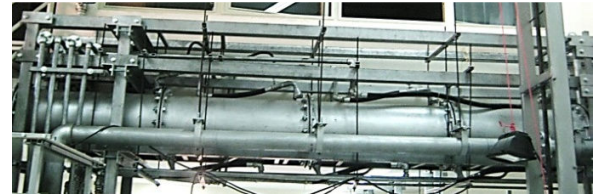

Fig. 5 Picture of air cooling line (MFL-TMU)



Fig. 6 Picture of inverter box with some air cooling lines (MFL-TMU)

B. Water Supply Loop

Two pumps and two tanks were used to supply water to the duct, as shown in Figs. 7 to 9. Water from the duct exit or water tap entered tank 2, and pump 2 moved the water to tank 1, which had an elevation of 6m. Tank 1 had two sections and a level controller that adjusted the water level and maintained a constant suction pressure constant for pump 1. In the event of an overflow, a second section in tank 1 drained water to the second part of tank 2. The water used for experiments was moved from tank 1 using pump 1, which maintained a constant suction pressure in pump 1 during different experiments.

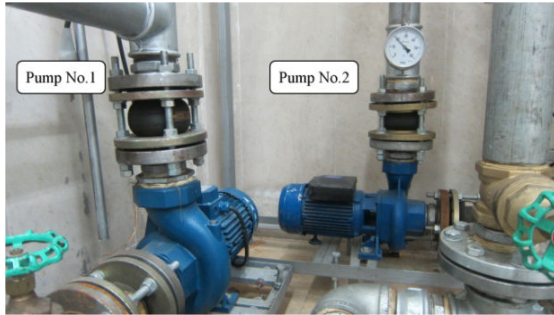

Fig. 7 Picture of Pumps No. 1 and 2 (MFL-TMU)

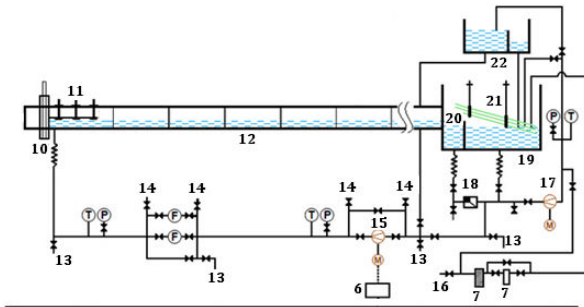

Fig. 8 Schematic of water supply cycle (MFL-TMU)

The water flow rate was controlled by in-line valves. The flow rate, temperature, and pressure were measured at the duct inlet.



Fig. 9 Picture of Tanks No. 1 and 2 in the water supply cycle (MFL-TMU)

C. Measurement Systems

The vortex air flow meter had an accuracy of $0.01\text{m}^3/\text{h}$. The magnetic water flow meter had an accuracy of $0.01\text{m}^3/\text{h}$. The flow meters were located in the air and water lines upstream of the duct inlet. Superficial velocities could be obtained by measuring the flow rate of air and water and knowing the void fraction at the duct inlet as well as channel dimensions.

The local pressures were measured using 13 piezoelectric pressure transducers along the duct, as shown in Table I. The measurement range of the pressure transducers was 0mbar to 250mbar with an accuracy of 1%.

TABLE I
 LOCATION OF PRESSURE TRANSDUCERS ALONG DUCT MEASURED FROM THE DUCT INLET

No.	Location (m)	Location ($\times D$)
1	1.00	14.99
2	3.80	56.97
3	5.40	80.96
4	9.40	140.93
5	12.40	185.91
6	14.60	218.89
7	16.60	248.88
8	18.60	278.86
9	20.60	308.85
10	23.80	356.82
11	25.80	386.81
12	29.80	446.78
13	33.80	506.75

Among these 13 pressure transducers, three first of them (i.e. P1 to P3) are more important because of measuring pressure in slug generation area. A schematic of the pressure transducers is shown in Fig. 10.

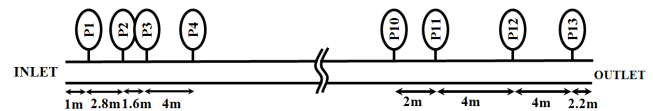

Fig. 10 Schematic of pressure transducers located along the duct

In the following, pressure diagrams of three first pressure transducers of a sample test are plotted. Pictures and videos of the experiments were recorded using a Canon IXY 32S camcorder.

D. Test Procedure

First, the water level was adjusted to void fractions of 0.25, 0.5, and 0.75 at the pre specified water flow rates. The minimum airflow rate was introduced into the duct to initiate a slug. Video was recorded for one minute as the flow regime was established at beginning of the duct after the flow would be stable. The airflow rate was then increased with pre specified steps at the same water flow rate until the airflow rate limit was reached. The water flow rate was then increased by one-step, and the airflow rate was increased from the lowest value up to the limit of the equipment as the slug regime continued. Volumetric flow rate of water is $2\text{m}^3/\text{hr}$ - $10\text{m}^3/\text{hr}$ (equivalent superficial velocity 0.11m/s to 0.56m/s) and volumetric flow rate of air is $33.84\text{m}^3/\text{hr}$ - $234\text{m}^3/\text{hr}$ (equivalent superficial velocity 1.88m/s - 13m/s). These ranges were in consistent with diagram map of [12].

Approximately 100 sets of results were obtained, which will be described in the results section.

IV. SLUG INITIATION POSITION IN TESTS

In the following, diagrams of slug initiation position at liquid holdups of 0.25, 0.50, and 0.75 versus superficial gas and liquid velocities are plotted. In addition, their analyses are discussed. Slug initiation position was a dimensionless parameter regards to hydraulic diameter of duct.

A. Liquid Holdup= 0.25

As increasing superficial liquid velocity, slug initiation position would be transferred to downstream. In every constant superficial liquid velocity, with increasing superficial gas velocity, the position was transferred to downstream, too (see Fig. 11).

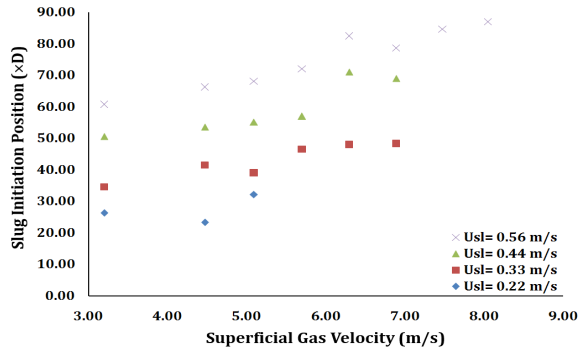

Fig. 11 Slug initiation position at different superficial liquid and gas velocities at liquid holdup of 0.25

In the tests conducted at liquid holdup of 0.25, the liquid height would be increased after dividing plate. This phenomenon is due to the low gas pressure on the liquid surface rather than liquid holdups of 0.50 and 0.75. The liquid height would be increased until lift force equilibrated with gas pressure. In addition, a hydraulic jump is occurred before slug generation at downstream (see Fig. 12).

As increasing superficial liquid velocity, liquid momentum would be increased. The increase of momentum caused delay in hydraulic jump occurrence. Since at liquid holdup 0.25, slug would be generated after hydraulic jump, therefore slug initiation position would be transferred to downstream.



Fig. 12 Hydraulic jump at liquid holdup of 0.25 with liquid surface increase, $U_{sl}=0.56\text{m/s}$, $U_{sg}=3.20\text{m/s}$ (MFL-TMU.)

As increasing superficial gas velocity, due to pressure increase on liquid surface, hydraulic jump position as well as slug initiation position transferred to downstream. This phenomenon is occurred only in liquid holdup 0.25. In the other words, in low liquid holdup, first, liquid surface is raised up to around 0.5; then slug would be generated, as seen in Fig. 13.

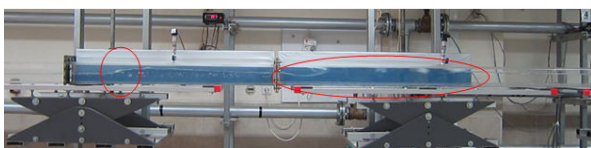

Fig. 13 Generated slug after hydraulic jump at liquid holdup of 0.25, $U_{sl}=0.56\text{m/s}$, $U_{sg}=3.20\text{m/s}$ (MFL-TMU)

At liquid holdup of 0.25, mean slug initiation position was 54.27D. As shown in Table II, overall minimum of slug initiation position occurred at first test (i.e. minimum superficial gas and liquid velocities) and overall maximum occurred at last test (i.e. maximum superficial gas and liquid velocities). Therefore, slug initiation position has direct dependency to superficial phase velocities.

TABLE II
 MINIMUM AND MAXIMUM SLUG INITIATION POSITION AT LIQUID HOLDUP OF 0.25

Test NO.	U_{sl} (m/s)	U_{sg} (m/s)	Slip ratio	Slug initiation position ($\times D$)	Description
1	0.22	4.47	20.32	23.25	Overall Min
28	0.56	8.05	14.37	87	Overall Max

Fig. 14 shows the pressure behavior for 30 seconds for test no. 9 at liquid holdup of 0.25 with superficial water and air velocities of 0.33m/s and 5.09m/s, respectively. One hundred pressure data points per second were recorded by the MATLAB DAQ software. Therefore, the horizontal axis is expressed in terms of 1/100 seconds. In this test, mean slug initiation position was 2.6m from inlet (equivalent 39D). As shown in Table I, slug initiation position was between pressure transducers 1 and 2.

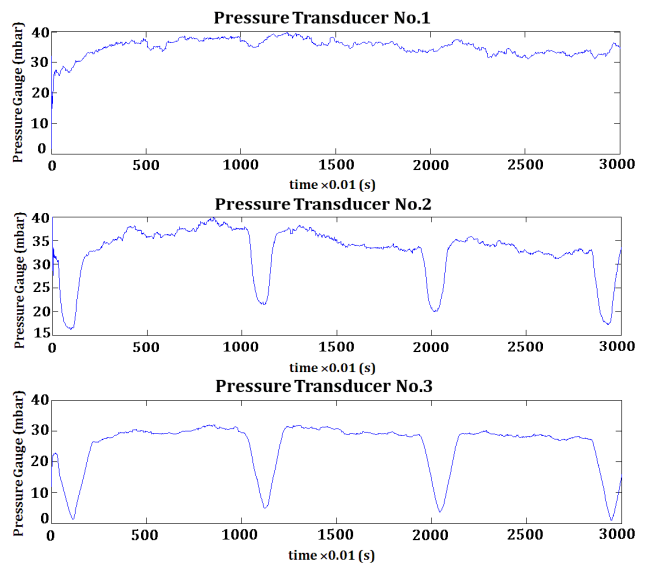

Fig. 14 Pressure behavior at a liquid holdup of 0.25, $U_{sl}=0.33\text{m/s}$, $U_{sg}=4.47\text{m/s}$, Test No. 9

Pressure transducer no.1 is located at 1m distance from inlet. The first slug creation position is after this PT. As can be seen from Fig. 14; maximum pressure is occurred at beginning of the duct. As the first slug is formed, the pressure pushed the liquid slug body to downstream. After slug passed from PT.2 and PT.3, the recorded pressure values have maximum value around PT.1; but they have relative minimum. These minimum pressures indicate passing the slug from the PT. when a slug makes contact with the sensor, the pressure measurement increases and remains at its maximum value

until the slug exits the duct. Duration of remaining of maximum pressure in the duct is 9s.

B. Liquid Holdup= 0.50

At liquid holdup of 0.50, when superficial gas velocity increases in each superficial liquid velocity, slug initiation position did not change so much (see Fig. 15).

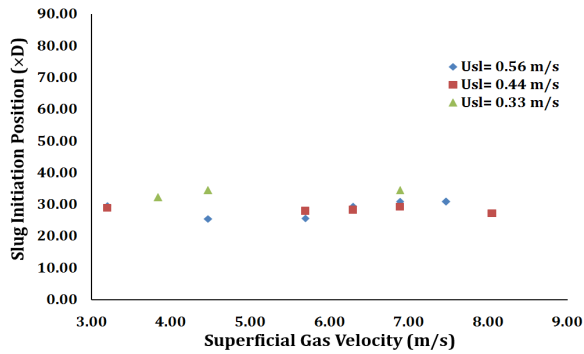

Fig. 15 Slug initiation position at different superficial liquid and gas velocities at liquid holdup of 0.50

At liquid holdup of 0.50, mean slug initiation position was 27.08D. As shown in Table III, overall minimum of slug initiation position occurred at 21st test and overall maximum occurred at 8th and 10th tests. Minimum and maximum points are in the median values of superficial liquid and gas velocities. It is concluded that in a constant superficial liquid velocity the increasing or decreasing trend did not see in this liquid holdup.

TABLE III
 MINIMUM AND MAXIMUM SLUG INITIATION POSITION AT LIQUID HOLDUP OF 0.50

Test NO.	U_{sl} (m/s)	U_{sg} (m/s)	Slip ratio	Slug initiation position (xD)	Description
21	0.56	4.47	8.05	25.50	Overall Min
8	0.33	4.47	13.41	34.50	Overall Max
10	0.33	6.89	20.67	34.50	Overall Max

Fig. 16 shows the pressure behavior for 30 seconds for test No. 8 at a liquid holdup of 0.50 with superficial water and air velocities of 0.33m/s and 4.47m/s, respectively. In this test, mean slug initiation position was 2.30m from inlet (equivalent 34.50D). As shown in Table I, slug initiation position was between pressure transducers no. 1 and 2.

Same as liquid holdup of 0.25, the first slug formation position is after PT.1. As can be seen in Fig. 16; flow conditions are similar to previous. The difference from the previous case is only the maximum pressure value. The maximum pressure for a liquid volume fraction of 0.5 is less than the maximum pressure for a liquid volume fraction of 0.25. As can be seen in Fig. 16, two types of slugs are formed; one flows 6s and another 11s in the duct.

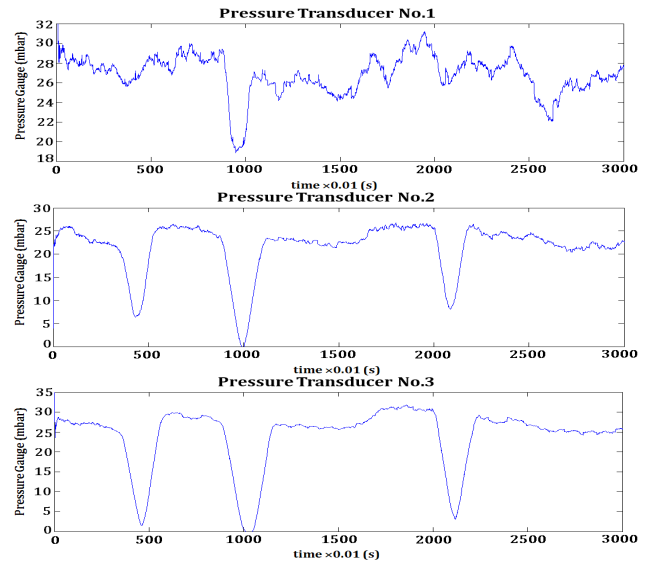

Fig. 16 Pressure behavior at a liquid holdup of 0.50, $U_{sl}=0.33\text{m/s}$, $U_{sg}=4.47\text{m/s}$, Test No. 8

C. Liquid Holdup= 0.75

At liquid holdup of 0.75, as increasing superficial liquid velocity, slug initiation position would be transferred to upstream. In this liquid holdup, superficial liquid velocity and slug initiation position act controversy. As superficial gas velocity increases, slug initiation position would be transferred to upstream. It is concluded that with increasing superficial gas and liquid velocities, slug would be occurred at nearer distance from the inlet of duct (see Fig. 17).

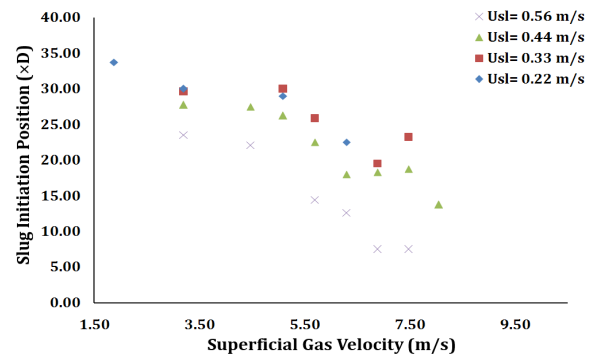

Fig. 17 Slug initiation position at different superficial liquid and gas velocities at liquid holdup of 0.75

As increasing superficial liquid and gas velocities, the momentum of these phases are increased. Increasing the momentums causes instability increase between phases. When surface instability (i.e. Kelvin-Helmholtz instability) increases, slug would be formed rapidly.

As shown in Table IV, minimum slug initiation position occurs at maximum superficial liquid velocity, because at high liquid and gas velocities, flow is prone to instability. It can be said that at maximum superficial liquid velocity (0.56m/s), when increasing gas velocity, slug initiation position would not be less than 7.50D.

TABLE IV
 MINIMUM AND MAXIMUM SLUG INITIATION POSITION AT LIQUID HOLDUP OF 0.75

Test NO.	U_{sl} (m/s)	U_{sg} (m/s)	Slip ratio	Slug initiation position ($\times D$)	Description
32	0.56	6.89	12.30	7.50	Overall Min
33	0.56	7.47	13.34	7.50	Overall Min
1	0.22	1.88	8.54	33.75	Overall Max

As shown in Table IV, mean slug initiation position was 21.65D. Overall minimum of slug initiation position occurred at the last tests (i.e. maximum superficial gas and liquid velocities) and overall maximum occurred at first test (i.e. minimum superficial gas and liquid velocities). Therefore, slug initiation position has inverse dependency with superficial phase velocities.

Fig. 18 shows the pressure behavior for 30 seconds for test No. 20 at a liquid holdup of 0.75 with superficial water and air velocities of 0.44m/s and 5.09m/s, respectively. In this test, mean slug initiation position was 1.75m from inlet (equivalent 26.25D). As shown in Table I, slug initiation position is between pressure transducers No. 1 and 2.

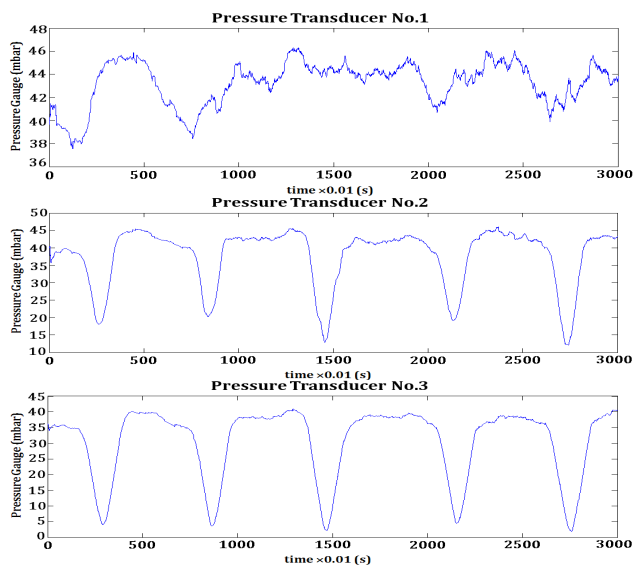

Fig. 18 Pressure behavior at a liquid holdup of 0.75, $U_{sl}=0.44\text{m/s}$, $U_{sg}=5.09\text{m/s}$, Test No. 20

Same as liquid holdups of 0.25 and 0.50, the first slug creation position is after PT.1. As can be seen, flow conditions are similar to previous holdups. The difference is in the maximum-recorded pressure. The maximum-recorded pressure value for a liquid holdup of 0.75 was higher than the liquid holdups of 0.25 and 0.50. In conclusion, the slugs are stronger than the previous cases. At this liquid holdup, slugs cause more damage to a pipeline. As can be seen in Fig. 18, duration of remaining of maximum pressure in the duct is 7s.

V. EMPIRICAL CORRELATION

By using the statistical least squares method and the superficial Reynolds dimensionless parameter for two phases (1), the slug frequency was calculated using the experimental

results with an accuracy of more than 95%, as shown in Table V.

$$\begin{aligned}
 U_{sg} &= \alpha_g U_g & U_{sl} &= \alpha_l U_l \\
 D_{hg} &= \frac{4A_g}{S_g + S_i} & D_{hl} &= \frac{4A_l}{S_l} \\
 Re_{sg} &= \frac{\rho_g D_{hg} |U_{sg}|}{\mu_g} & Re_{sl} &= \frac{\rho_l D_{hl} |U_{sl}|}{\mu_l}
 \end{aligned} \tag{1}$$

which, D_h , A , S , ρ , and μ are hydraulic diameter, area, perimeter, density, and kinematic viscosity, respectively. Subscripts g, l, and i refers to gas, liquid, and interface, respectively.

TABLE V
 SLUG FREQUENCY CORRELATIONS AT DIFFERENT LIQUID HOLDUPS

Inlet liquid holdup	Dimensionless slug initiation position	Error rate (%)
0.25	$S.P. = 2.82 \times 10^{-5} Re_{sl}^{1.01} Re_{sg}^{0.44} - 0.14$	3.27
0.50	$S.P. = 0.79 Re_{sl}^{-0.98} Re_{sg}^{-0.91} + 27.18$	3.42
0.75	$S.P. = 2706.2 Re_{sl}^{-0.007} Re_{sg}^{-0.006} - 2351.6$	4.43

VI. CONCLUSION

In this paper, the effect of inlet superficial velocities and for the first time, liquid holdups on slug initiation position in two-phase air-water flow was considered experimentally. Empirical correlations to calculate slug initiation position were also presented. The experiments were carried at the Multiphase Flow Lab of Tarbiat Modares University. The experiments were conducted at three different liquid holdups (0.25, 0.5 and 0.75) using a horizontal Plexiglas duct with a cross section of 5cm \times 10cm (hydraulic diameter of 6.67cm) and a length of 36m (equivalent to 540D). The results are summarized as follows:

1. Growing of waves with long wavelength in gas-liquid stratified flow in a horizontal duct, may be transformed to a roll wave or reach to top of the duct (i.e. bridge the duct) and form a slug.
2. At liquid holdup of 0.25, slug creation is different from two other liquid holdups. In this case, in the first, a hydraulic jump is formed far from inlet. Liquid surface after jump is raised to a higher holdup (0.50 to 0.85) dependent to upstream condition. Therefore, the cross section of the gas would be narrow (see Fig. 12). When gas flow section decreased, air velocity would be increased, due to the flow rate of air is constant. When Liquid flow section increased, water velocity would be decreased, due to the Flow rate of water is constant, too. Therefore, the air velocity increased and the water velocity decreased simultaneously, i.e. the difference between them would be higher after jump relative to before it. Regard to K-H instability, the probability of wave growth to form slug would be increased.
3. At liquid holdup of 0.25, minimum, maximum, and mean slug initiation positions were 23.25D, 87D, and 56.34D, respectively. Therefore, slugs were formed at far from inlet (greater than 40D) averagely. At constant superficial

gas velocity, when superficial liquid velocity increased, slug initiation position would be transferred to more far from inlet. At constant superficial liquid velocity, when superficial gas velocity increased, slug initiation position would be transferred to more far from inlet, too. Slug initiation position is dependent to superficial gas and liquid velocities monotonically increasing.

4. At liquid holdup of 0.50, minimum, maximum, and mean slug initiation positions were 25.50D, 34.50D, and 27.08D, respectively. Therefore, slugs were formed at close to inlet (less than 40D) averagely. When superficial gas velocity increases in each superficial liquid velocity, slug initiation position did not change so much.
5. At liquid holdup of 0.75, minimum, maximum, and mean slug initiation positions were 7.50D, 33.75D, and 21.65D, respectively. Therefore, slugs were formed at close to inlet (less than 40D) averagely. At constant superficial gas velocity, when superficial liquid velocity increased, slug initiation position would be transferred to closer to inlet. At constant superficial liquid velocity, when superficial gas velocity increased, slug initiation position would be transferred to closer to inlet, too. Slug initiation position is dependent to superficial gas and liquid velocities monotonically decreasing.
6. As increasing liquid holdup from 0.25 to 0.75, dependency of slug initiation position to superficial phases velocities, varies from monotonically increasing to monotonically decreasing.
7. The pressure measurements indicated that dangerous slugs (i.e., slugs with high pressure) were generated at liquid holdups of 0.25 and 0.75. However, the cases with a liquid volume fraction of 0.5 did not generate high-pressure slugs. In other words, when volume fraction of two phases were equal, the formed slugs had less pressure (weaker) and when volume fraction of two phases were not equal, the formed slugs had high pressure (stronger).

ACKNOWLEDGMENT

The authors wish to thank Mr. Saeid Ahmadi and Mr. Behzad Sadeghi (MSc graduated of Mechanical Engineering, TMU) which helped us in tests procedure.

REFERENCES

- [1] Y. Taitel, C. Sarica, J.P. Brill, "Slug flow modelling for downward inclined pipe flow: theoretical considerations", *Int. J. Multiphase Flow* 26, 2000, pp 833-844.
- [2] D. Barnea, Y. Taitel, "A model for slug length distribution in gas-liquid slug flow", *Int. J. Multiphase Flow* 19, 1993, pp 829-838.
- [3] O. J. Nydal, S. Pintus and P. Andreussi, "Statistical characterization of slug flow in horizontal pipes", *Int. J. Multiphase Flow* 18, No. 3, 1992, pp. 439-453,
- [4] C.J. Crowley, G.B. Wallis, J.J. Barry, "Validation of a one-dimensional wave model for the stratified-to-slug flow regime transition, with consequences for wave growth and slug frequency", *Int. J. Multiphase Flow* 18, 1992, pp 249-271.
- [5] A. Sanchis, G. W. Johnson, A. Jensen, "The formation of hydrodynamic slugs by the interaction of waves in gas-liquid two-phase pipe flow", *Int. J. Multiphase Flow* 37, 2011, pp 358-368.
- [6] X. Wang, G. Liejin, X. Zhang, "An experimental study of the statistical parameters of gas-liquid two-phase slug flow in horizontal pipeline", (Technical Note), *Int. J. Heat and Mass Transfer* 50, 2007, pp 2439-2443.
- [7] Z. Fan, F. Lusseyran, T.J. Hanratty, "Initiation of slugs in horizontal gas-liquid flows", *AIChE J.*, 39 (11), 1993, pp 1741-1753.
- [8] S.R. Davies, "Studies of Two-phase Intermittent Flow in Pipelines", Ph.D. Thesis, University of London., 1992.
- [9] C.P. Hale, "Slug Formation, Growth and Collapse", Ph.D. Thesis, University of London., 2000.
- [10] P. M. Ujang, Ch. J. Lawrence, C. P. Hale, G. F. Hewitt, "Slug initiation and evolution in two-phase horizontal flow", *Int. J. Multiphase Flow* 32, 2006, pp 527-552.
- [11] M.R. Ansari, "Dynamical behavior of slug initiation generated by short waves in two-phase air-water stratified flow", *ASME HTD* 361, 1998, pp 289-295.
- [12] M.R. Ansari, B. Arzandi, "Two-phase gas-liquid flow regimes for smooth and ribbed rectangular ducts", *Int. J. Multiphase Flow* 38, 2012, pp 118-125.