

Effect of Tethers Tension Force in the Behavior of a Tension Leg Platform Subjected to Hydrodynamic Force

Amr R. El-Gamal, Ashraf Essa, Ayman Ismail

Abstract—The tension leg platform (TLP) is one of the compliant structures which are generally used for deep water oil exploration. With respect to the horizontal degrees of freedom, it behaves like a floating structure moored by vertical tethers which are pretension due to the excess buoyancy of the platform, whereas with respect to the vertical degrees of freedom, it is stiff and resembles a fixed structure and is not allowed to float freely. In the current study, a numerical study for square TLP using modified Morison equation was carried out in the time domain with water particle kinematics using Airy's linear wave theory to investigate the effect of changing the tether tension force on the stiffness matrix of TLP's, the dynamic behavior of TLP's; and on the fatigue stresses in the cables. The effect was investigated for different parameters of the hydrodynamic forces such as wave periods, and wave heights. The numerical study takes into consideration the effect of coupling between various degrees of freedom. The stiffness of the TLP was derived from a combination of hydrostatic restoring forces and restoring forces due to cables. Nonlinear equation was solved using Newmark's beta integration method. Only uni-directional waves in the surge direction was considered in the analysis. It was found that for short wave periods (i.e. 10 sec.), the surge response consisted of small amplitude oscillations about a displaced position that is significantly dependent on tether tension force, wave height; whereas for longer wave periods, the surge response showed high amplitude oscillations that is significantly dependent on wave height, and that special attention should be given to tethers fatigue because of their high tensile static and dynamic stress.

Keywords—Tethers tension, tension leg platforms, hydrodynamic wave forces, wave characteristic.

I. INTRODUCTION

A significant part of the world oil and natural gas reserves lies beneath the sea bed. The drilling and production operation to exploit this offshore oil and gas supplies is generally done from offshore platforms. Compliant platforms are used in deep water, where the stiffness of a fixed platform decreases while its cost increases, and they are the only technical solution in very deep water (>500 m). TLP is one of compliant platforms which is basically a floating structure moored by vertical tubular member, or "tethers". These tethers

are pretension due to the excess buoyancy of the platform. As, the platform translates horizontally, the horizontal component of the pretension in the tethers tends to force the platform back to its original position. The TLP is compliant in horizontal plane, but quite rigid in the vertical direction. The TLP has a six degree of freedom, shown in Fig. 1. Which can be conveniently divided into two categories, those controlled by the stiffness of tethers, and those controlled by the buoyancy. The former category includes motion in the vertical plane and consists of heave, roll and pitch; whereas the latter comprises the horizontal motions of surge, sway and yaw.. The concept of TLP has been in existence since the early 1970's. Since the original concept of the TLP put forward.

Most of the literature available Paulling and Horton [6] reported a method of predicting the platform motions and tether forces due to regular waves using a linearized hydrodynamic synthesis technique. Each member was assumed to be cylindrical in shape with cross-sectional dimensions small in comparison to both the length of the cylinder and the wave length. Ahmad et al, [2] studied the effect of the variable submergence on the maximum tether tension force on TLP with change in wave incidence angle. The study was carried out on coupled and uncoupled model. Jain [5] dynamic response analysis of a TLP to deterministic first order wave forces is presented, considering coupling between the degrees-of-freedom (surge, sway, heave, roll, pitch and yaw). The analysis considers nonlinearities produced due to changes in cable tension and due to nonlinear hydrodynamic drag forces. The wave forces on the elements of the pontoon structure are calculated using Airy's wave theory and Morison's equation ignoring diffraction effects. The nonlinear equation of motion is solved in the time domain by Newmark's beta integration scheme. The effects of different parameters that influence the response of the TLP are then investigated. Like change in tether tension force and damping ratio. Chan K. Yang, M. H. Kim [4] developed a numerical study of the transient effect of tendon disconnection on global performance of an extended tension leg platform (ETLP) during harsh environmental conditions of Gulf Of Mexico (GOM). A. M. Abou-Rayan, Ayman A. Seleemah, and Amr R. El-gamal [1] developed a numerical study on determining the dynamic responses of TLPs subjected to regular wave. They found that coupling between various degrees of freedom has insignificantly dependent on the wave height; whereas for longer wave periods of 15 sec. Amr R. El-gamal, Ashraf Essa [3] developed a numerical study to

A. R. is with the Civil Engineering Department, Faculty of Engineering at Benha, Benha University, Assistant Lecturer, Egypt (phone: 002-01000941720; fax: 13512; e-mail: engamramadan@yahoo.com).

A. E. is with the Civil Engineering Department, National Building Research Center, Associated prof., Egypt (phone: 00201143043638; fax: 1770; email: ashraf_20022003@yahoo.com).

A. I. is with the Steel and Structure Engineering Department, National Building Research Center, Egypt (phone: 00201143043638; fax: 1770; e-mail: ayman.m.ismail@gmail.com).

investigate the effect of tethers length and wave characteristics such as wave period and wave height on the response of TLP's. they found that for short wave periods (i.e. 10 sec.), the surge response consisted of small amplitude oscillations about a displaced position that is significantly dependent on tether length, wave height; whereas for longer wave periods, the surge response showed high amplitude oscillations about that is significantly dependent on tether length.

In this paper, a numerical study was conducted to investigate the dynamic response of a square TLP (shown in Fig. 2) under hydrodynamic forces considering all degrees of freedom of the system. The analysis was carried out using modified Morison equation in the time domain with water particle kinematics using Airy's linear wave theory to investigate the effect of changing the tether tension force on the stiffness matrix of TLP's, the dynamic behavior of TLP's; and on the fatigue stresses in the cables. The effect was investigated for different parameters of the hydrodynamic forces such as wave periods, and wave heights. The numerical study takes into consideration the effect of coupling between various degrees of freedom. The stiffness of the TLP was derived from a combination of hydrostatic restoring forces and restoring forces due to cables and the nonlinear equations of motion were solved utilizing Newmark's beta integration scheme. The effect of wave characteristics such as wave period and wave height on the response of TLP's was evaluated. Only uni-directional waves in the surge direction was considered in the analysis.

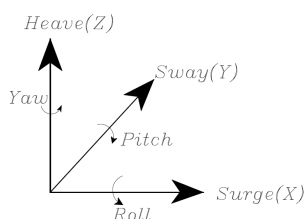

Fig. 1 Six degree of freedom of offshore structure

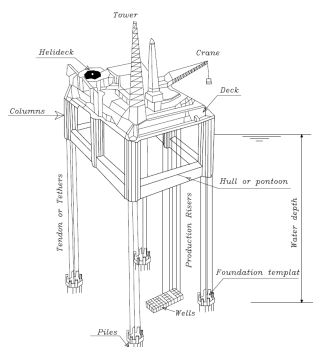

Fig. 2 Tension leg platform scheme

II. STRUCTURAL IDEALIZATION AND ASSUMPTIONS

The general equation of motion of the square configuration TLP model under a regular wave is given as

$$[M]\{\ddot{x}\} + [C]\{\dot{x}\} + [K]\{x\} = \{F(t)\} \quad (1)$$

where, $\{x\}$ is the structural displacement vector, $\{\dot{x}\}$ is the structural velocity vector, $\{\ddot{x}\}$ is the structural acceleration vector; $[M]$ is the structure mass matrix; $[C]$ is the structure damping matrix; $[K]$ is the structure stiffness matrix; and $\{F(t)\}$ is the hydrodynamic force vector.

The mathematical model derived in this study assumes that the platform and the tethers are treated as a single system and the analysis is carried out for the six degrees of freedom under different environmental loads where wave forces are estimated at the instantaneous equilibrium position of the platform utilizing Morison's equation and using Airy's linear wave theory. Wave force coefficients, C_d and C_m , are the same for the pontoons and the columns and are independent of frequencies as well as constant over the water depth. The following assumptions were made in the analysis.

- 1) Change in pre-tension is calculated at each time step, so the equation of equilibrium at each time step modifies the elements of the stiffness matrix.
- 2) The platform has been considered symmetrical along the surge axis. Directionality of wave approach to the structure has been ignored in the analysis and only a uni-directional wave train has been considered.
- 3) The damping matrix has been assumed to be mass and stiffness proportional.
- 4) The force on tethers (gravity, inertia, and drag, hydrostatic and hydrodynamic forces) has been neglected because of its small area and also the tether curvature is not significant in motion; only the axial forces acting on tethers have been considered.
- 5) Hydrodynamic forces on connecting members and mooring legs have been neglected.
- 6) The wave, current and structure motions are taken to occur in the same plane and in the same direction, the interaction of wave and current has been ignored.
- 7) Integration of hydrodynamic inertia and drag forces are carried out up to the actual level of submergence, when variable submergence is considered.

III. DEVELOPMENT OF A RECTANGLE TLP MODEL

A. Draft Evaluation

At the original equilibrium position, Fig. 3, summation of forces in the vertical direction gives:

$$W + T = F_B \quad (2)$$

We find that

$$D_r = \frac{[(W + T) / (0.25 \rho \pi g)] - (2D_p^2 s_a) - (2D_p^2 s_b)}{4D_c^2} \quad (3)$$

where, F_B is the total buoyancy force; W is the total weight of the platform in air; T is the total instantaneous tension in the tethers; T_0 is the initial pre-tension in the tether; ρ is the mass

density of sea water; D_c is the diameter of TLP columns; D_p is the diameter of pontoon; S_a and S_b are the length of the pontoon between the inner edges of the columns in the x and y directions, respectively; and D_r is the draft.

We notice from eq. (3) that drift distance directly proportion to tether tension force.

B. Stiffness Matrix of Rectangle TLP Configuration

The stiffness of the platform is derived from a combination of hydrostatic restoring forces and restoring forces due to the cables. Restoring force for motions in the horizontal plane (surge, sway, and yaw) are the horizontal component of the pretension in the cables, while restoring forces for motions in the vertical plane arise primarily from the elastic properties of the cables, with a relatively small contribution due to hydrostatic forces.

For more detailed about the derivation of the stiffness matrix, the reader is referred to [1]

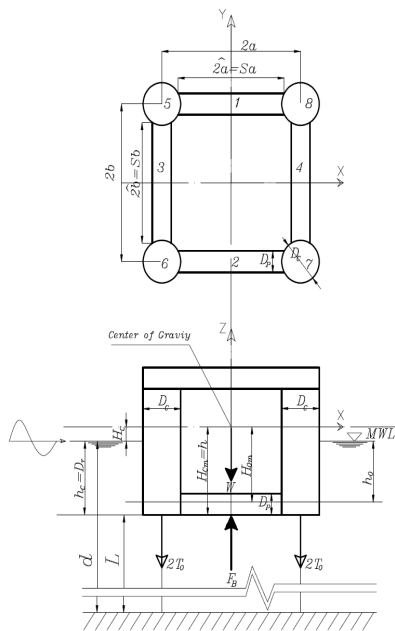

Fig. 3 The Square TLP (plan and elevation)

The overall stiffness matrix shows:

- 1) The presence of off-diagonal terms, which reflects the coupling effect between the various degrees of freedom.
- 2) The coefficients depend on the change in the tension of the tethers, which is affecting the buoyancy of the system. Hence, the matrix is response dependent.
- 3) Hence, during the dynamic analysis, the [K] matrix is not constant for all time instants, but its components are continuously changing at each time step depending upon the response values at the previous time step.
- 4) The coefficient for heave stiffness matrix doesn't depend on tether tension force while the surge coefficient directly proportion to tether tension force and inverse proportion to tether length.

C. Mass Matrix, [M]

The mass matrix is assumed to be lumped at each degree of freedom. Hence, it is diagonal in nature and is constant. However, the added mass, M_a , due to the water surrounding the structural members has been considered up to the mean sea level (MSL) and arising from the modified Morison equation. The presence of off diagonal terms in the mass matrix indicates a contribution of the added mass due to the hydrodynamic loading. The fluctuating components of added mass due to the variable submergence of the structure in water is considered in the force vector depending upon whether the sea surface elevation is above or below the MSL. The loading will be attracted only in the surge, heave and pitch degrees of freedom due to the unidirectional wave acting in the surge direction on a symmetric configuration of the platform about the x and z axes.

For more detailed about the derivation of the mass matrix, the reader is referred to [1]

D. Structural Damping [C]

Damping was presented in the form of alpha and beta damping (Rayleigh Damping). The damping matrix [C] is calculated by using alpha and beta constants as multipliers to the mass matrix [M] and stiffness matrix [K], respectively.

$$[C] = \alpha[M] + \beta[K] \quad (4)$$

The values of α and β are calculated based on typical modal damping ratios, ζ .

E. Hydrodynamic Force Vector, {F(t)} on Square TLP

The hydrodynamic force vector is calculated in each degree of freedom according to modified Morison's equation which takes into account the relative velocity and acceleration between the structure and the fluid particles. It is also worth mentioning that the ratio d/H can be related to d/λ . Based on the limiting heights of breaking waves, it become unstable and break when $H/\lambda \geq 0.1$, (λ is the wave length).

For the uni-directional wave train in the surge direction, the force vector {F(t)}, is given by

$$F(t) = \{F_{11} \quad F_{21} \quad F_{31} \quad F_{41} \quad F_{51} \quad F_{61}\}^T \quad (5)$$

Since the wave is unidirectional, there would be no force in the sway degree-of-freedom F_{21} and hence there will be no moment in the roll degree of-freedom F_{41} . Because of the vertical water particle velocity and acceleration, the heave degree-of-freedom would experience wave force F_{31} . The force in the surge direction F_{11} on the vertical members will cause moment in the pitch degree-of-freedom F_{51} . However, forces in the surge degree-of-freedom are symmetrical about the X axis (due to the symmetry of the platform to the approaching wave) and there will be no net moment caused in the yaw degree-of-freedom F_{61} .

For more detailed about the derivation of the force vector, the reader is referred to [1]

F. Solution of the Equation of Motion in the Time Domain

The equation of motion is coupled and nonlinear and can be written as

$$[M]\{x''(t+\Delta t)\}+[C]\{x'(t+\Delta t)\}+[K]\{x(t+\Delta t)\}=\{F(t+\Delta t)\} \quad (6)$$

Equation (6) is nonlinearly coupled, because of the presence of structural displacement, velocity and acceleration in the right hand side of the equation. Therefore, the force vector should be updated at each time step to account for the change in the tether tension. To achieve this response variation a time domain analysis is carried out. The Newmark's beta time integration procedure is used in a step wise manner. This procedure was developed by Newmark together with a family of time-stepping methods. The following values are updated

- 1) Stiffness coefficients which vary with tether tension.
- 2) Added mass which varies with sea surface fluctuations.
- 3) Wave forces at the instantaneous position of the displaced structure.

IV. RESULTS AND DISCUSSION

A numerical scheme was developed using MATLAB software where solution based on Newmark's beta method was obtained. The geometric properties of the TLP and the hydrodynamic data considered for force evaluation are given in Table I.

Table II shows the coupled natural time periods of the structure in such case. It is observed that TLPs have natural periods of motion in the horizontal plane are high, whereas in the vertical plane the periods are low. Generally, the surge and sway motions are predominantly high for head seas due to the combined actions of wind, waves and currents. However, due to coupling among various degrees of freedom and relatively low damping of hydrodynamic origin in the vertical plane motion, a complete analysis of a six degree-of-freedom system subjected to wind, waves and currents is desirable. Moreover, the structural flexibility in the horizontal motions causes nonlinearity in the structural stiffness matrix because of large deformations.

The natural periods in vertical plane in heave, roll and pitch are observed to be in the range of 1 to 3 seconds which is consistent with typical TLP's. While this range is below the periods of typical storm waves, everyday waves do have some energy in this range (the lowest wave period for most geographical locations is about 3 seconds). Thus, wave-excited vibrations can cause high-cycle fatigue of tethers and eventually instability of the platform. One alternative to this problem is to increase the moored stiffness as to further lower the natural periods in heave, roll and pitch movement. The other alternative is to install damping devices in the tethers to mitigate vertical motion.

It is observed that the tether tension force is inversely proportional to the natural time period for surge movement, as any increase in tether tension leads to increase in the TLP stiffness.

Also, it can be noted that the natural period in the heave movement is almost unchanged.

Time histories of the coupled responses are shown in Figs. 3 to 18. Before going into detailed discussion for each response it is clear from the figures that the tether tension force affects the drift value of the displaced position in the surge direction as the tether tension force increase the value of the drift decrease.

TABLE I
 GEOMETRIC PROPERTIES OF THE SQUARE TLP AND LOAD DATA

Water properties	
Gravity acceleration (m/sec ²)	9.81
Water weight density (kN/m ³)	10
Inertia coefficient, C _m	1.7
Drag coefficient, C _d	0.8
Current velocity (m/sec), U _c	0
Wave period (sec), T _w	10 and 15
Wave height (m), H _w	8 and 10
Platform properties	
Platform weight (KN), W	330000
Platform length (m), 2a	75.66
Platform width (m), 2b	75.66
Platform radius of gyration in x-directions (m), r _x	35.1
Platform radius of gyration in y-directions (m), r _y	35.1
Platform radius of gyration in z-directions (m), r _z	42.4
Tether total force (KN), T	67750, 101625 and 135500
Tether area (m ²)	0.40
Draft (m)	19.3, 24.8 and 30.3
Tether modulus of elasticity (kn/m ²), E	2.2e7
Diameter of columns (m), D _c	14
Diameter of pontoon (m), D _p	12
Center of gravity above the keel (m), h	27.47
Water depth (m), d	1000
Damping ratio, ζ	0.05

TABLE II
 CALCULATED NATURAL STRUCTURAL PERIODS FOR DIFFERENT ANALYSIS CASES (IN SECONDS)

DOF	Analysis Case		
	Tether total force 67750KN	Tether total force 101625 KN	Tether total force 135500 KN
Surge	172.504	143.6771	126.8009
Sway	172.504	143.6771	126.8009
Heave	2.4062	2.3996	2.3929
Roll	2.1876	2.1777	2.1696
Pitch	2.1876	2.1777	2.1686
Yaw	134.8259	113.8702	101.7491

A. Surge Response

The time histories of the surge responses for the square TLP are shown in Figs. 4 to 7. It is observed that, for a specific wave period, the amplitude of oscillations increases as the wave height increases. For short period the system responds in small amplitude oscillations about a displaced position that is directly proportional to wave height. The amplitude of oscillations increases with the increase in the wave period, which is expected because as the wave period increases, it becomes closer to the surge natural period of vibration (about

150 sec.). Moreover, in all cases, the surge response seems to have periodic oscillations that have the same exciting wave period [3].

The effect of tether tension force is obvious in Figs. 4 to 7 which indicate that it affect the drift value of the displaced position. As tension force becomes bigger the drift decreases but the force of the tethers has little effect on the amplitude of the oscillation. Finally, the transient state takes about 100-150 seconds where the stationary state begins.

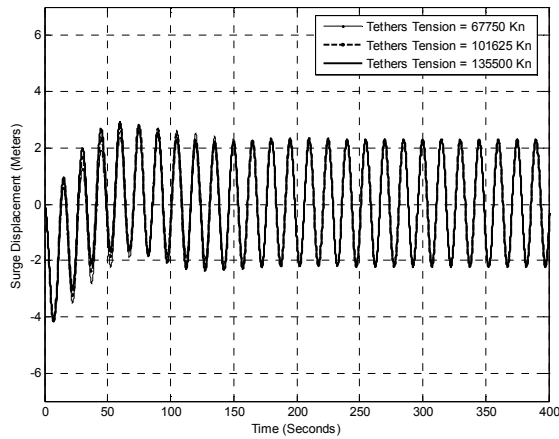

Fig. 4 Coupled Surge response of square TLP for Wave Height = 8 m and wave period = 15 sec

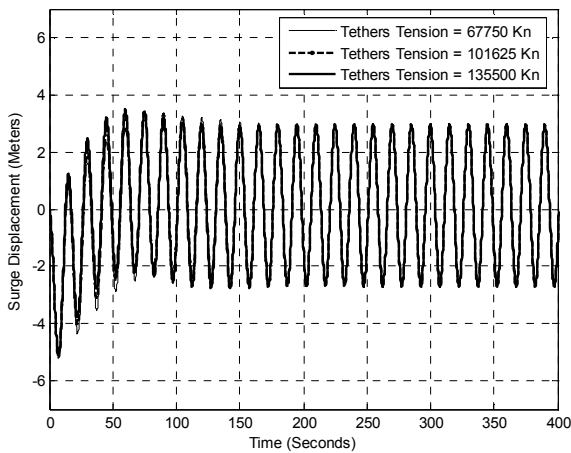

Fig. 5 Coupled Surge response of square TLP for Wave Height = 10 m and wave period = 15 sec

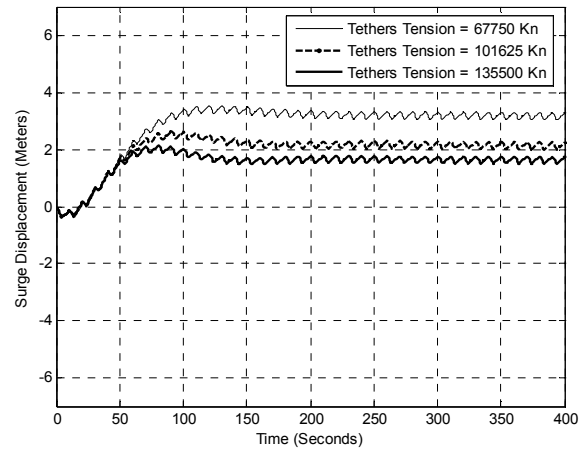

Fig. 6 Coupled Surge response of square TLP for Wave Height = 8 m and wave period = 10 sec

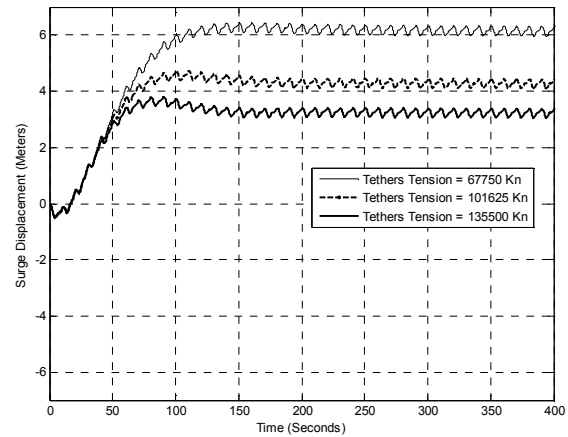

Fig. 7 Coupled Surge response of square TLP for Wave Height = 10 m and wave period = 10 sec

B. Heave Response

The time histories are shown in Figs. 8 to 11. As expected, the response in the heave direction has very small values compared to that of the surge direction. This is attributed to the relatively high stiffness of the tethers in this direction together with the fact that the excitation is indirect in this case. Moreover, the heave response is inversely proportional to the wave period and directly proportional to wave height. The heave response appears to have a mean value of nearly zero. It is obvious that the increase of tether tension decrease the amplitude of the heave response. Also, the transient state takes about 10 seconds where the stationary state begins and the motion is almost periodic.

It is interesting to note that, even both: the stiffness of TLP and the hydrodynamic force doesn't depend directly on tether tension force in heave movement, the increase in tether tension force leads to increase in the drift value which reduce the tether length, which affect indirectly the heave movement.

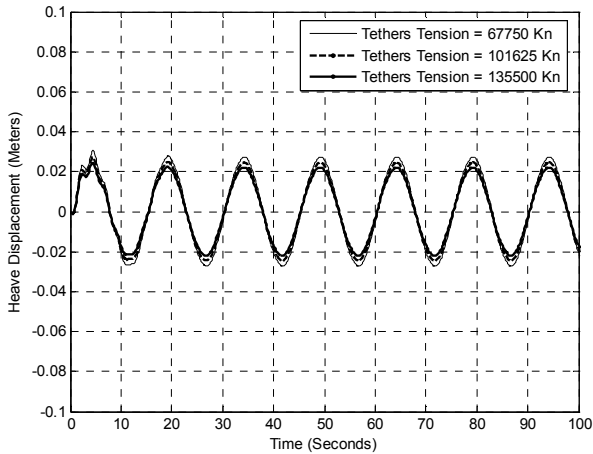

Fig. 8 Coupled Heave response of square TLP for Wave Height = 8 m and wave period = 15 sec

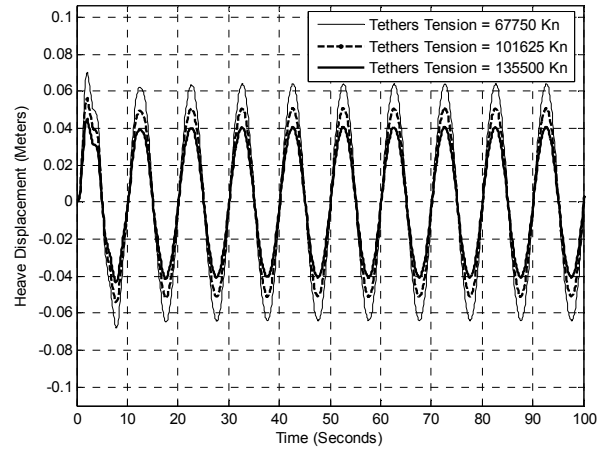

Fig. 11 Coupled Heave response of square TLP for Wave Height = 10 m and wave period = 10 sec

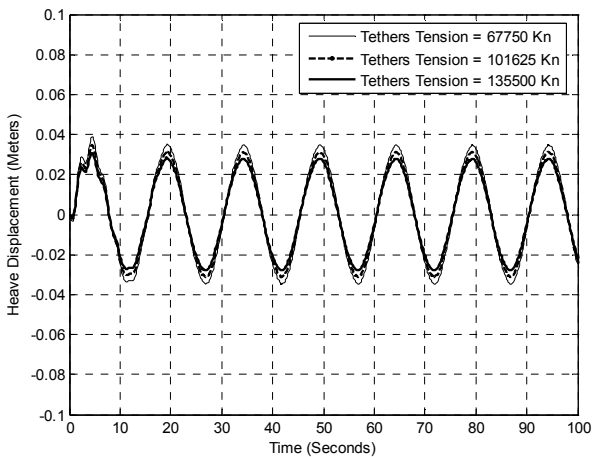

Fig. 9 Coupled Heave response of square TLP for Wave Height = 10 m and wave period = 15 sec

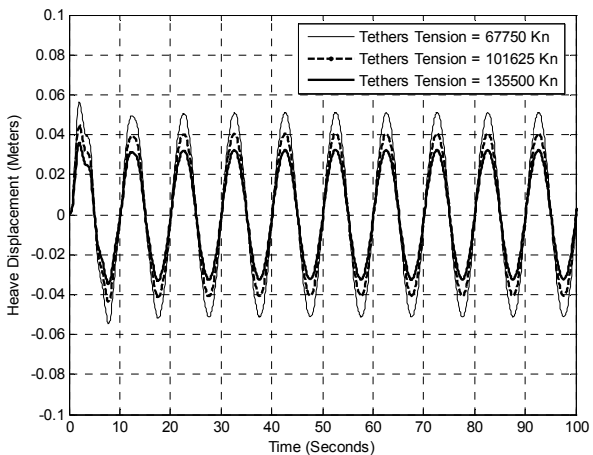

Fig. 10 Coupled Heave response of square TLP for Wave Height = 8 m and wave period = 10 sec

C. Pitch Response

The time histories shown in Figs. 12 to 15 it is clear that the increase of tether tension decrease the amplitude of the pitch response and that effect is more obvious for small wave period. Also the pitch response is inversely proportional to the wave period and directly proportional- but to a less extent- to wave height. The pitch response appears to have a mean value of nearly zero. Moreover, the transient state takes about 20-40 seconds before the stationary state begins.

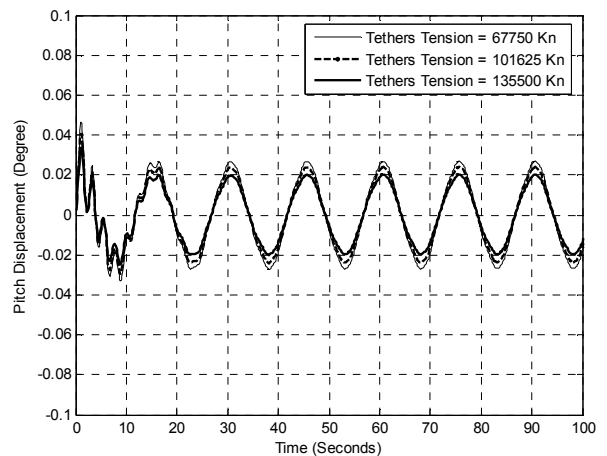

Fig. 12 Coupled Pitch response of square TLP for Wave Height = 8 m and wave period = 15 sec

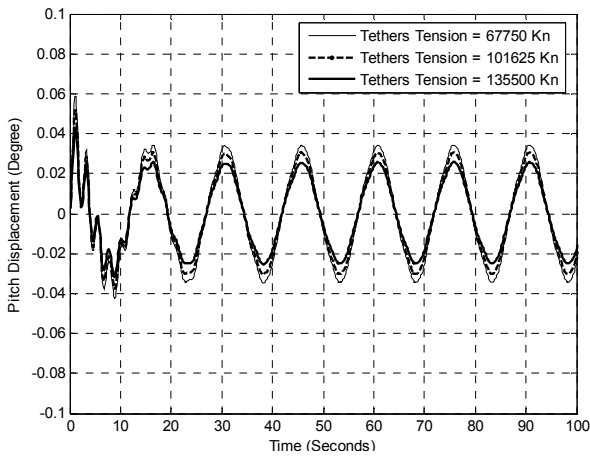

Fig. 13 Coupled Pitch response of square TLP for Wave Height = 10 m and wave period = 15 sec

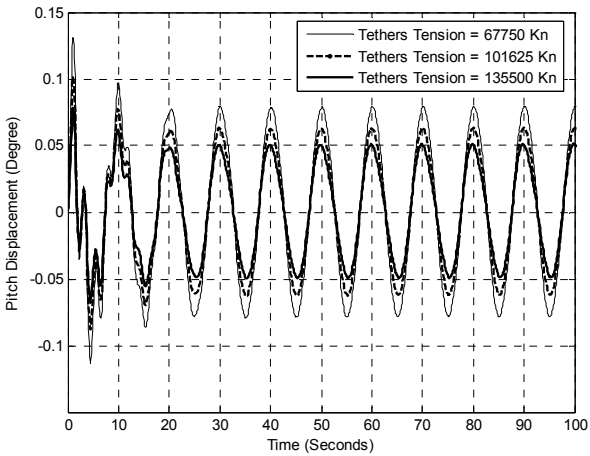

Fig. 14 Coupled Pitch response of square TLP for Wave Height = 8 m and wave period = 10 sec

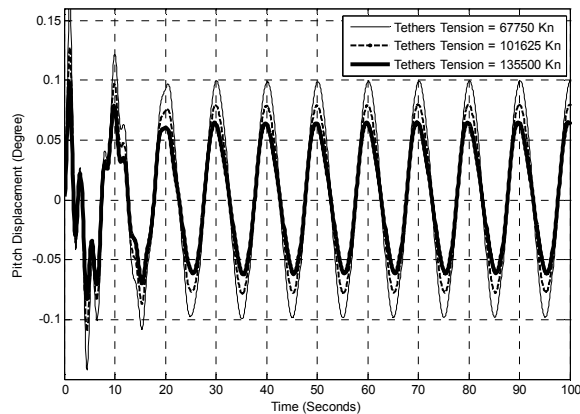

Fig. 15 Coupled Pitch response of square TLP for Wave Height = 10 m and wave period = 10 sec

D. Change in tether tension force

The time histories for the change in tether tension force for the square TLP are shown in Figs. 16 to 19.

It is observed that, for a specific wave period, the change in tether tension force increases as the wave height increases.

For long wave period the change of tether tension force is not affected by the initial tether tension force as the magnitude of the tension change is slightly different, however regarding the ratio of change in tension force, it increased as initial tension reduced, leading to more probability of fatigue damage.

For short wave period it can be observed that the permanent increase in tether tension force is higher for smaller initial tether tension force.

Also, for short wave period the initial tether tension force affect the magnitude of the tension change, the value of change of the tension force is greatly increase with the reduction of the initial tether tension force. That if we assume the same initial tension stress is introduced in the cables the smaller tether tension force will lead to a more probability of fatigue damage.

So, we can state that different tethers of the TLP are likely to be subjected to significantly different magnitudes of stress fluctuation. Thus, probabilities of fatigue damage could be different in various tethers and special attention should be given to tethers because of their high tensile static and dynamic stress.

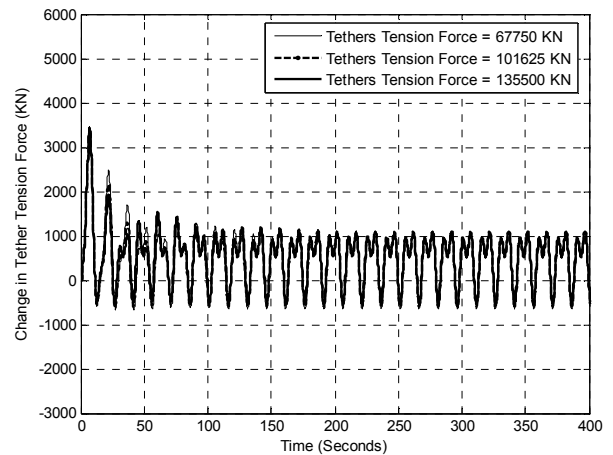

Fig. 16 Change in tether tension force of square TLP for Wave Height = 8 m and wave period = 15 sec

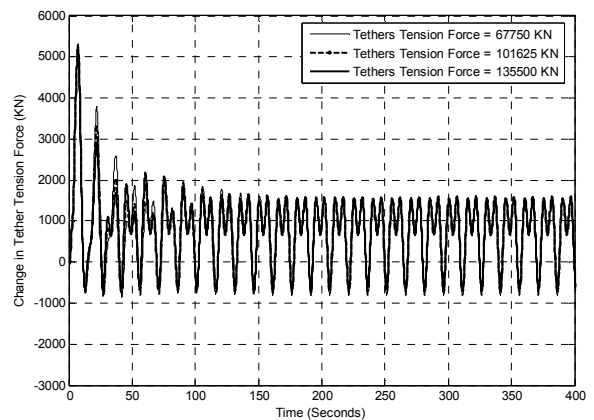

Fig. 17 Change in tether tension force of square TLP for Wave Height = 10 m and wave period = 15 sec

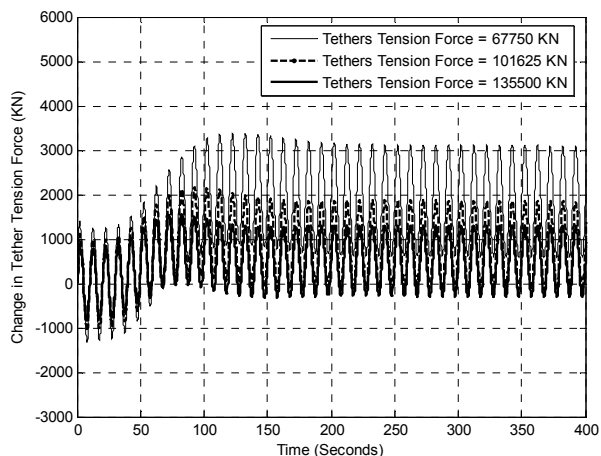

Fig. 18 Change in tether tension force of square TLP for Wave Height = 8 m and wave period = 10 sec

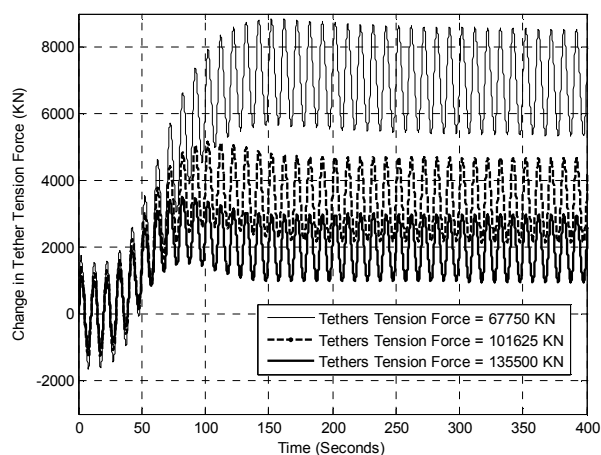

Fig. 19 Change in tether tension force of square TLP for Wave Height = 10 m and wave period = 10 sec

V. CONCLUSIONS

The present study investigates the effect of change of tension force in the tethers on the dynamic response of a square TLP under hydrodynamic forces in the surge direction considering all degrees of freedom of the system. A numerical dynamic model for the TLP was written where Morison's equation with water particle kinematics using Airy's linear wave theory was used. Results for the time histories for the affected degrees of freedom have been presented. Based on the results shown in this paper, the following conclusions can be drawn:

- 1) The natural periods of the surge, sway and yaw motions were in the range of (120 to 170) depending on the tension in tethers, however these periods are higher than typical wave spectral peaks (8 to 15) which precludes resonance with the wave diffraction forces.
- 2) The natural time period of TLP is inversely proportional to the tether tension force
- 3) The surge displaced position decreased as tether tension force increase while the amplitude is slightly affected.

- 4) Wave height affects the surge response oscillations. It increases both the amplitude for long wave period, and the displaced position distance for short wave period
- 5) The heave response is inversely proportional to the tether tension force.
- 6) The Pitch response is inversely proportional to the tether tension force and that effect is more obvious for small wave period.
- 7) Different magnitudes of stress fluctuations leading to different probabilities of fatigue damage can occur.
- 8) The magnitude of stress changes depends on the tether tension force, and wave period and wave height
- 9) For long wave period the change in tension force is not affected by tether tension value, but increase as a ratio with reduction in tension force.
- 10) For short wave period the change in tension force is increases in both magnitude and a ratio with the reduction of initial tether tension force leading to more probability of fatigue damage.

REFERENCES

- [1] Abou-Rayyan, A.M., Seleemah, A., and El-gamal, A.R., "Response of Square Tension Leg Platforms to Hydrodynamic Forces", *Ocean Systems Engineering*, Vol. 2 (2), 2012, pp. 115 – 135.
- [2] Ahmed, S., Bhaskar sengupta, A. Ali, "Nonlinear Dynamic Response of Tension Lrg Platform Tether under Offshore Environmental Conditions", *Ocean Engineering*, Vol.30, 1990, pp. 232-241.
- [3] Amr R. El-gamal, Ashraf Essa, Influence of Tether Length in the Response Behavior of Square Tension Leg Platform in Regular Waves, *International Journal of Civil Science and Engineering*, Vol.7 ,No.12,2013, 2013, pp.643-650.
- [4] Chan K. Yang, M. H. Kim, 2010, "Transient Effects of Tendon Disconnection of a TLP by Hull-Tendon –Riser Coupled Dynamic Analysis", *Ocean Engineering*, Vol. 37, 2010, pp. 667-677.
- [5] Jain, A. K., "Nonlinear Coupled Response of Offshore Tension Leg Platforms to Regular Wave Forces", *Ocean Engineering*, Vol. 24, 1997, pp. 577-592.
- [6] Pauling, J. R, Horton, E.E., "Analysis of the Tension Leg Stable Platform", In: *Proceedings of the Offshore Technology Conference*, OTC NO. 1263, 1970, pp. 379-390.