

STATCOM based Damping Controller in Power Systems for Enhance the Power System Stability

Sangram Keshori Mohapatra, Sidhartha Panda, Prasant Kumar Satpathy

Abstract—This paper describes the power-system stability improvement by a static synchronous compensator (STATCOM) based damping controller with Differential evolution (DE) algorithm is used to find out the optimal controller parameters. The present study considered both local and remote signals with associated time delays. The performances of the proposed controllers have been compared with different disturbances for both single-machine infinite bus power system and multi-machine power system. The performance of the proposed controllers with variations in the signal transmission delays has also been investigated. To show the effectiveness and robustness of the proposed controller the Simulation results are presented under different disturbances and loading conditions.

Keywords—Controller Design, Differential Evolution Algorithm Static Synchronous Compensator, Time Delay, Power System Stability, Single Machine Infinite-bus Power System, Multi-Machine Power System.

I. INTRODUCTION

RECENT development of power electronics introduces the use of flexible ac transmission systems (FACTS) controllers in power systems [1]. Subsequently, within the FACTS initiative, it has been demonstrated that variable shunt compensation is highly effective in both controlling power flow in the lines and in improving stability [2], [3]. Low frequency oscillations are observed when large power systems are interconnected by relatively weak tie lines. These oscillations may sustain and grow to cause system separation if no adequate damping is available [4]. With the advent of Flexible AC Transmission System (FACTS) technology, shunt FACTS devices play an important role in controlling the reactive power flow in the power network and hence the system voltage fluctuations and Stability [1], [5]–[7]. Static synchronous Compensator (STATCOM) is member of FACTS family that is connected in shunt with the system [8], [9]. In order to increase of the system and damping response which makes the inverter in the STATCOM to inject voltage

or current to compensate the three phase fault [10]. Even though the primary purpose of STATCOM is to support bus voltage by injecting (or absorbing) reactive power, it is also capable of improving the power system stability [11]. When a STATCOM is present in a power system to support the bus voltage, a supplementary damping controller could be designed to modulate the STATCOM bus voltage in order to improve damping of system oscillations [12], [13]. Artificial intelligence-based approaches have been proposed recently to design a FACTS-based supplementary damping controller. These approaches include genetic algorithm [14], particle swarm optimization [14]–[16], differential evolution [17], multi-objective evolutionary algorithm [18] etc. In the design of an efficient and effective damping controller, selection of the appropriate input signal is a primary issue. Input signal must give correct control actions when a disturbance occurs in the power system. Most of the available literatures on damping controller design are based on either local signal or remote signal. Also the issues related to potential time delays due to sensor time constant and signal transmission delays are hardly addressed in the literature. Despite significant strides in the development of advanced control schemes over the past two decades, the conventional lead-lag structure controller remains the controllers of choice in many industrial applications. The conventional lead-lag controller structure remains an engineer's preferred choice because of its structural simplicity, reliability, and the favorable ratio between performance and cost. Beyond these benefits, it also offers simplified dynamic modeling, lower user-skill requirements, and minimal development effort, which are issues of substantial importance to engineering practice. In view of the above, a lead-lag structure controller has been considered in the present study to modulate the STATCOM reference voltage. A number of conventional techniques have been reported in the literature pertaining to design problems of lead-lag structure controller, namely the eigenvalue assignment, mathematical programming, gradient procedure for optimization, and also the modern control theory and linear matrix inequalities [19] optimization. Unfortunately, the conventional techniques are time consuming as they are iterative and require heavy computation burden and slow convergence. In addition, the search process is susceptible to be trapped in local minima, and the solution obtained may not be optimal. The evolutionary methods constitute an approach to search for the optimum solutions via some form of directed

S. K. Mohapatra is working as Asst. Professor in the Department of Electrical Engineering, C. V. Raman College of Engineering, Bhubaneswar, Odisha, India (e-mail: sangram_muna@rediffmail.com).

S.Panda is working as Professor in the Department of Electrical & Electronics Engineering, VSSUT, Burla, Odisha, India (e-mail: anda_sidhartha@rediffmail.com).

P. K. Satpathy is working as Professor in the Department of Electrical Engineering, CET, Bhubaneswar, Odisha, India (e-mail: satpathy.pks@gmail.com).

random search process. A relevant characteristic of the evolutionary methods is that they search for solutions without previous problem knowledge. Differential evolution (DE) is a branch of evolutionary algorithms developed by Rainer Storn and Kenneth Price in 1995 for optimization problems [20]. It is a population-based direct search algorithm for global optimization capable of handling non-differentiable, non-linear and multi-modal objective functions, with few, easily chosen, control parameters. It has demonstrated its usefulness and robustness in a variety of applications such as, Neural network learning, Filter design and the optimization of aerodynamics shapes. DE differs from other evolutionary algorithms (EA) in the mutation and recombination phases. DE uses weighted differences between solution vectors to change the population whereas in other stochastic techniques such as genetic algorithm (GA) and expert systems (ES), perturbation occurs in accordance with a random quantity. DE employs a greedy selection process with inherent elitist features. Also it has a minimum number of EA control parameters, which can be tuned effectively [17]. In recent years, the fast development of communication technology, low price communication devices and various communication media makes it possible to provide the control center with the real time signals from remote areas. However, the use of centralized controller entails inputs that may arrive after a certain time delay. Time delays can make the control system have less damping features. In order to satisfy specifications for wide-area control systems, the design of a controller should take into account this time delay in order to provide a controller that is robust, not only for the range of operating conditions desired, but also for the uncertainty in delay. Recently there is a growing interest in designing the controllers in the presence of uncertain time delays [21], [22]. In view of the above, this paper investigates the design of a SVC-based damping controller considering the potential time delays. Line active power as local signal and speed deviation as remote signal are considered as candidate input signals for the proposed STATCOM based damping controller. For controller design, differential evolution algorithm is employed to tune controller parameters. To show the robustness of the proposed design approach simulation results are presented under various disturbance and faults for both single-machine infinite-bus and multi-machine power system. Also, a comparison has been made between remote and local signal and results are presented and analyzed.

II. SYSTEM MODEL

A. Single-Machine Infinite-Bus Power System with STATCOM

To design and optimize the STATCOM-based damping controller, a single-machine infinite-bus system with STATCOM, shown in Fig. 1, is considered at the first instance. The system comprises a synchronous generator connected to an infinite-bus through a step-up transformer and a STATCOM followed by a double circuit transmission line.

The generator is equipped with hydraulic turbine & governor (HTG) and excitation system. The HTG represents a nonlinear hydraulic turbine model, a PID governor system, and a servomotor. The excitation system consists of a voltage regulator and DC exciter, without the exciter's saturation function [23]. In Fig. 1, Trf represents the transformer; V_T and V_B are the generator terminal and infinite-bus voltages respectively. All the relevant parameters are given in Appendix. STATCOM is basically a synchronous voltage source generating controllable AC behind a transformer leakage reactance. The voltage source converter is connected to an energy storage unit, usually a DC capacitor. The voltage difference across the reactance produces the reactive power exchange between the STATCOM and the power system

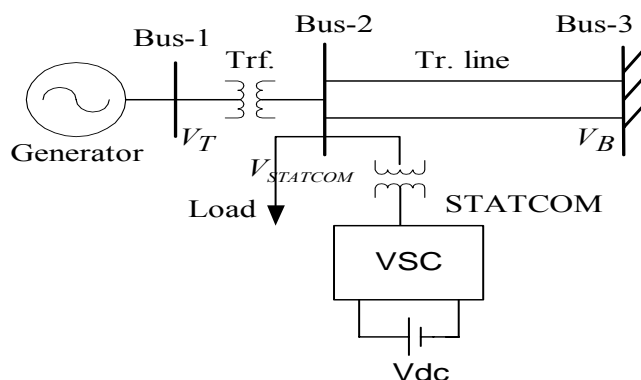

Fig. 1 Single-machine infinite-bus power system with STATCOM

III. THE PROPOSED APPROACH

A. Structure of STATCOM-Based Damping Controller

The commonly used lead-lag structure shown in Fig. 2 is chosen in this study as a STATCOM-based damping controller. The lead-lag structure is preferred by the power system utilities because of the ease of on-line tuning and also lack of assurance of the stability by some adaptive or variable structure techniques. The structure consists of a delay block, a gain block with gain K_S , a signal washout block and two-stage phase compensation block. The time delay introduced due to delay block depends on the type of input signal. For local input signals only the sensor time constants is considered and for remote signals both sensor time constant and the signal transmission delays are included. The signal washout block serves as a high-pass filter, with the time constant T_W , high enough to allow signals associated with oscillations in input signal to pass unchanged. From the viewpoint of the washout function, the value of T_W is not critical and may be in the range of 1 to 20 seconds [4]. The phase compensation blocks (time constants T_{1S} , T_{2S} and T_{3S} , T_{4S}) provide the appropriate phase-lead characteristics to compensate for the phase lag between input and the output signals. In Fig. 3, V_{ref} represents the reference voltage as desired by the steady operation of the system. The steady state loop acts quite slowly in practice and hence, in the present study V_{ref} is assumed to be constant

during the disturbance period. The desired value of reference voltage is obtained according to the change in the STATCOM reference $\Delta V_{STATCOM}$ which is added to V_{ref} to get the desired voltage reference $V_{STATCOM_ref}$.

B. Problem Formulation

In the lead-lag structured controllers, the washout time constants T_W is usually pre-specified [1], [12], [14]. A washout time constant $T_W = 10s$ is used in the present study. The controller gain K_S and the time constants T_{1S} , T_{2S} , T_{3S} and T_{4S} are to be determined. During steady state conditions $\Delta V_{STATCOM}$ and V_{ref} are constant. During dynamic conditions the reference voltage $\Delta V_{STATCOM}$ is modulated to damp system oscillations. The effective reference voltage $V_{STATCOM_ref}$ in dynamic conditions is given by:

$$V_{STATCOM_ref} = V_{ref} + \Delta V_{STATCOM} \quad (1)$$

In the design of a robust damping controller, selection of the appropriate input signal is a main issue. Input signal must give correct control actions when a disturbance occurs in the power system. Both local and remote signals can be used as control. To avoid additional costs associated with communication and to improve reliability, input signal should preferably be locally measurable. However, local control signals, although easy to get, may not contain the desired oscillation modes. So, compared to wide-area signals, they are not as highly controllable and observable. Owing to the recent advances in optical fiber communication and global positioning systems, the wide-area measurement system can realize phasor measurement synchronously and deliver it to the control center even in real time, which makes the wide-area signal a good alternative for control input. In a wide-area monitoring system, global positioning system synchronized time-stamped data are used. In today's technology, dedicated communication channels should not have more than 50-ms delay for the transmission of measured signals even in the worst scenarios [19]. For local input signals, line active power, line reactive power, line current magnitude and bus voltage magnitudes are all candidates to be considered in the selection of input signals for the FACTS power oscillation damping controller. Among these possible local input signals, active power and current are the most commonly employed in the literature. Similarly, generator rotor angle and speed deviation can be used as remote signals. However rotor speed seems to be a better alternative as input signal for FACTS based controller [13]. In view of the above, both line active power and speed deviations are considered and compared as candidate input signals for the STATCOM based controller. For local signals a sensor time constant of 15 ms is considered. For remote signals a signal transmission delay of 50 ms is considered along with the sensor time constant of 15 ms. In the present study, an integral time absolute error of the speed deviations is taken as the objective function J expressed as:

$$J = \int_{t=0}^{t=t_{sim}} |\Delta\omega| \cdot t \cdot dt \quad (2)$$

where, $\Delta\omega$ is the speed deviation in and t_{sim} is the time range of the simulation. For objective function calculation, the time-domain simulation of the power system model is carried out for the simulation period. It is aimed to minimize this objective function in order to improve the system response in terms of the settling time and overshoots. The problem constraints are the STATCOM controller parameter bounds. Therefore, the design problem can be formulated as the following optimization problem.

Minimize

$$J \quad (3)$$

Subject to

$$\begin{aligned} K_S^{\min} &\leq K_S \leq K_S^{\max} \\ T_{1S}^{\min} &\leq T_{1S} \leq T_{1S}^{\max} \\ T_{2S}^{\min} &\leq T_{2S} \leq T_{2S}^{\max} \\ T_{3S}^{\min} &\leq T_{3S} \leq T_{3S}^{\max} \\ T_{4S}^{\min} &\leq T_{4S} \leq T_{4S}^{\max} \end{aligned} \quad (4)$$

where K^{\min} and K^{\max} are the lower and upper bounds of the STATCOM controller and T^{\min} and T^{\max} are the lower and upper bounds of the time constants of the controllers.

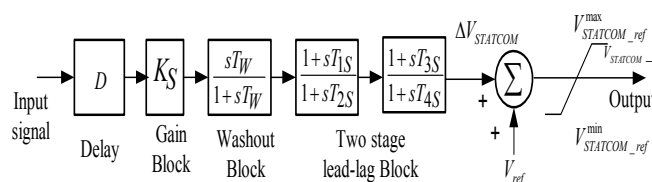

Fig. 2 Structure of proposed STATCOM-based damping controller

IV. DIFFERENTIAL EVOLUTION

Differential Evolution (DE) algorithm is a stochastic, population-based optimization algorithm recently introduced [20]. DE works with two populations; old generation and new generation of the same population. The size of the population is adjusted by the parameter N_p . The population consists of real valued vectors with dimension D that equals the number of design parameters/control variables. The population is randomly initialized within the initial parameter bounds. The optimization process is conducted by means of three main operations: mutation, crossover and selection. In each generation, individuals of the current population become target vectors. For each target vector, the mutation operation produces a mutant vector, by adding the weighted difference between two randomly chosen vectors to a third vector. The

crossover operation generates a new vector, called trial vector, by mixing the parameters of the mutant vector with those of the target vector. If the trial vector obtains a better fitness value than the target vector, then the trial vector replaces the target vector in the next generation. The evolutionary operators are described below [17]:

A. Initialization

For each parameter j with lower bound X_j^L and upper bound X_j^U , initial parameter values are usually randomly selected uniformly in the interval $[X_j^L, X_j^U]$.

B. Mutation

For a given parameter vector $X_{i,G}$, three vectors ($X_{r1,G}$ $X_{r2,G}$ $X_{r3,G}$) are randomly selected such that the indices i , $r1$, $r2$ and $r3$ are distinct. A donor vector $V_{i,G+1}$ is created by adding the weighted difference between the two vectors to the third vector as:

$$V_{i,G+1} = X_{r1,G} + F \cdot (X_{r2,G} - X_{r3,G}) \quad (5)$$

where F is a constant from (0, 2)

C. Crossover

Three parents are selected for crossover and the child is a perturbation of one of them. The trial vector $U_{i,G+1}$ is developed from the elements of the target vector ($X_{i,G}$) and the elements of the donor vector ($X_{i,G}$). Elements of the donor vector enters the trial vector with probability CR as:

$$U_{j,i,G+1} = \begin{cases} V_{j,i,G+1} & \text{if } rand_j \leq CR \text{ or } j = I_{rand} \\ X_{j,i,G+1} & \text{if } rand_j > CR \text{ or } j \neq I_{rand} \end{cases} \quad (6)$$

with $rand_{j,i} \sim U(0,1)$, I_{rand} is a random integer from $(1,2,\dots,D)$ where D is the solution's dimension i.e. number of control variables. I_{rand} ensures that $V_{i,G+1} \neq X_{i,G}$.

D. Selection

The target vector $X_{i,G}$ is compared with the trial vector $V_{i,G+1}$ and the one with the better fitness value is admitted to the next generation. The selection operation in DE can be represented by the following equation:

$$X_{i,G+1} = \begin{cases} U_{i,G+1} & \text{if } f(U_{i,G+1}) < f(X_{i,G}) \\ X_{i,G} & \text{otherwise.} \end{cases} \quad (7)$$

where $i \in [1, N_p]$. Fig. 3 shows the vector addition and subtraction necessary to generate a new candidate solution and Flow chart of proposed DE optimization approach as shown in Fig. 4.

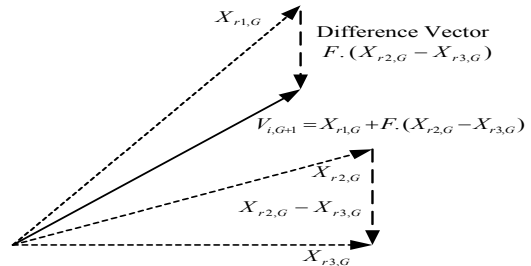

Fig. 3 Vector addition and subtraction in DE to generate a new candidate solution

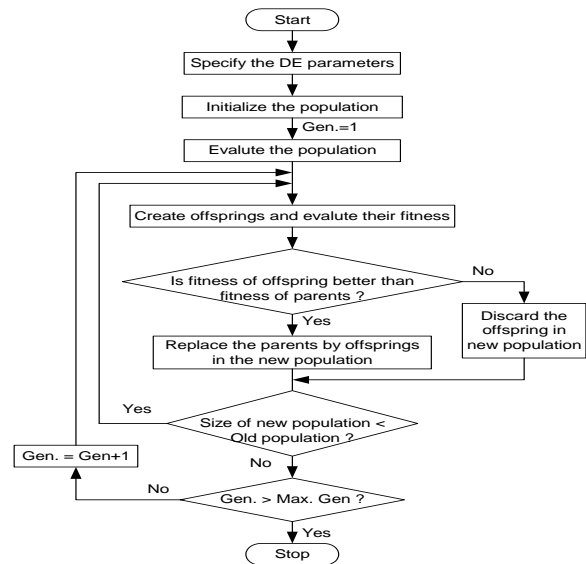

Fig. 4 Flow chart of proposed DE optimization approach

V. RESULTS AND DISCUSSIONS

The behavior underlying the performance of a synchronous machine with the excitation system, mechanical control system, and installed FACTS controller etc., is represented by a set of non-linear differential equations. Thus the complete mathematical description of a power system becomes difficult to solve. To simplify the computational burden, linearized models are used which gives satisfactory results under small disturbance conditions. However, linear models cannot properly capture complex dynamics of the system, especially during major disturbances. This presents difficulties for tuning the FACTS controllers in that, the controllers tuned to provide desired performance at small disturbance condition do not guarantee acceptable performance in the event of major disturbances. The complete non-linear model of the power system with FACTS can be developed in MATLAB/SIMULINK using the inbuilt non-linear power system components or by developing the non-linear models of

some power system components. The SimPowerSystems (SPS) toolbox is used for all simulations and STATCOM-based damping controller design [23]. SPS is a MATLAB-based modern design tool that allows scientists and engineers to rapidly and easily build models to simulate power systems using Simulink environment. In order to optimally tune the parameters of the STATCOM based damping controller, as well as to assess its performance, the model of example power system shown in Fig. 1 is developed using SPS blockset. (Please refer to Appendix for relevant parameters). The optimization of the proposed STATCOM-based damping controller parameters is carried out by minimizing the fitness given in (2) employing DE algorithm. The model of the system under study has been developed in MATLAB/SIMULINK environment and DE program has been written in .m file. For objective function calculation, the developed model is simulated in a separate program (by another .m file using initial population/controller parameters) considering a disturbance. From the SIMULINK model the objective function value is evaluated and moved to workspace. The process is repeated for each individual in the population. The objective function is evaluated for each individual by simulating the example power system, considering a severe disturbance. For objective function calculation, a 3-phase short-circuit fault in one of the parallel transmission lines is considered. The flow chart of the DE algorithm employed in the present study is given in Fig. 4. Simulations were conducted on a Pentium 4, 3 GHz, 1GB RAM computer, in the MATLAB 7.8.0 environment. The optimization was repeated 20 times and the best final solution among the 20 runs is chosen as proposed controller parameters. The best final solutions obtained in the 20 runs are given in Table I.

TABLE I

STATCOM BASED CONTROLLER PARAMETERS FOR SMIB POWER SYSTEM					
Signal/ parameters	Ks	T _{1s}	T _{2s}	T _{3s}	T _{4s}
Remote	197.777	2.3244	1.0297	0.0109	1.3568
Local	49.5691	1.5243	0.8222	2.2033	0.3422

TABLE II
LOADING CONDITIONS CONSIDER

Loading conditions	P_e in per unit (pu)	δ_0 in Degree
Nominal	0.85	51.51°
Light	0.5	29.33°
Heavy	1	60.73°

A. Simulation Result

During normal operating condition there is complete balance between input mechanical power and output electrical power and this is true for all operating points. During disturbance, the balance is disturbed and the difference power enters into/drawn from the rotor. Hence the rotor speed deviation and subsequently all other parameters (power, current, voltage etc.) change. As the input to the STATCOM controller is the speed deviation/electrical power, the STATCOM reference voltage is suitable modulated and the

power balanced is maintained at the earliest time period irrespective of the operating point. So, with the change in operating point also the STATCOM controller parameters remain fixed. To assess the effectiveness and robustness of the proposed controller, three different operating conditions as given in Table II are considered. At the first instance the remote speed deviation signal is considered as the input signal to the proposed STATCOM-based controller. The following cases are considered:

Case I: Nominal Loading

The behavior of the proposed controller is verified at nominal loading condition under severe disturbance condition. A 5 cycle, 3-phase self clearing fault is applied at the middle of one transmission line connecting bus 2 and bus 3, at $t = 1.0$ s. The system response under this severe disturbance is shown in Figs. 5-8 where, the response without control (no control) is shown with dotted line, and the response with proposed approach with Local signal are considered is shown with dash line and time delay with Remote signal are considered with solid line respectively. For comparison, it can be seen from Figs. 5-8 that when potential time delays are considered the proposed approach Remote signal with time delay is better than Local signal.

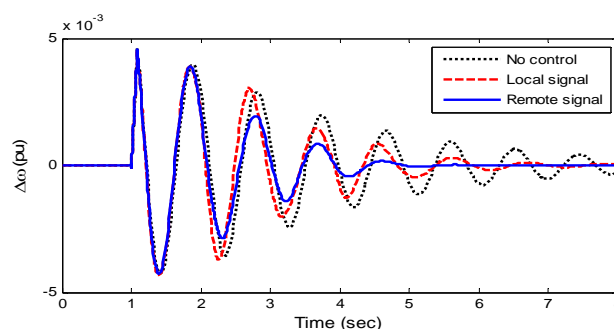

Fig. 5 Speed deviation response for 5 cycle 3-ph fault in transmission line with nominal loading

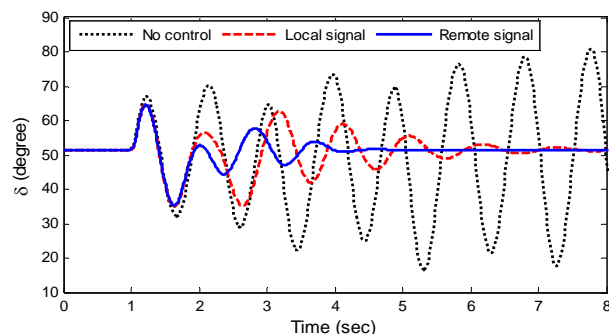

Fig. 6 Rotor angle response for 5 cycle 3-ph fault in transmission line with nominal loading

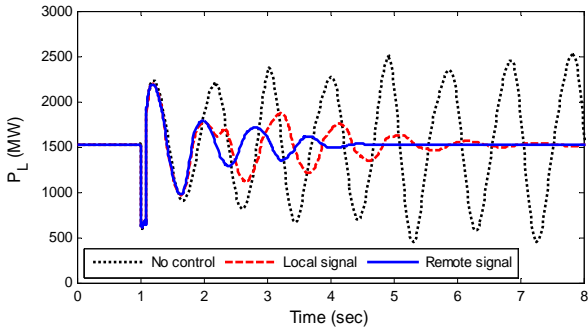

Fig. 7 Tie-line power flow response for 5 cycle 3-ph fault in transmission line with nominal loading

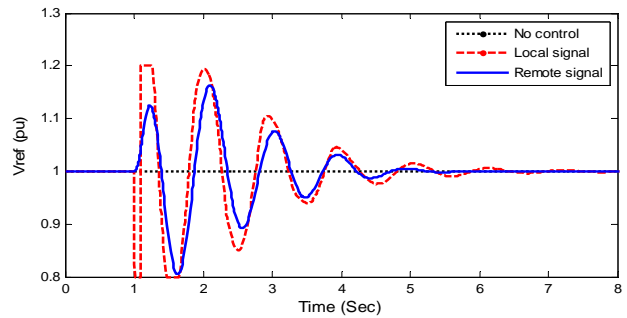

Fig. 11 Vref voltage with Light loading

Case II: Light Loading

To test the robustness of the controller to the operating condition and type of disturbance, the generator loading is changed to light loading condition as given in Table II. A 5 cycle 3-phase fault is assumed in one of the parallel transmission line near bus 2 at $t=1.0$ s. The fault is cleared by tripping the faulted line and the lines are reclosed after 5 cycles. The system Response under this contingency is shown in Figs. 9-11 which clearly depicts the robustness of the proposed controller for changes in operating condition and fault location. It can be seen that the proposed design approach Remote signal is better than Local signal.

Case III: Heavy Loading

The robustness of the proposed controller is also verified at heavy loading condition under small disturbance by disconnecting the load near bus 1 at $t=1.0$ s for 5 cycle with generator loading being changed to heavy loading condition. The system Response under this contingency is shown in Figs. 12, 13 from which it is clear that the system is unstable without control under this severe disturbance and the stability of the system is maintained with the proposed DE optimized STATCOM-based damping controller

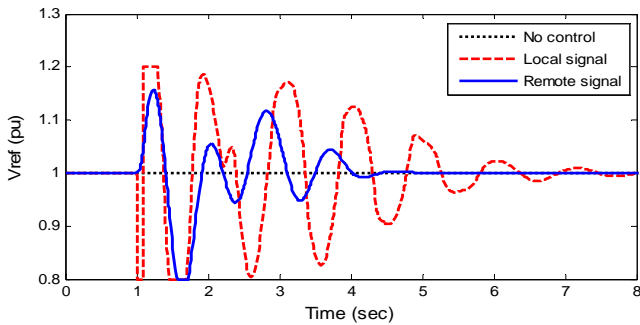

Fig. 8 Vref voltage with nominal loading

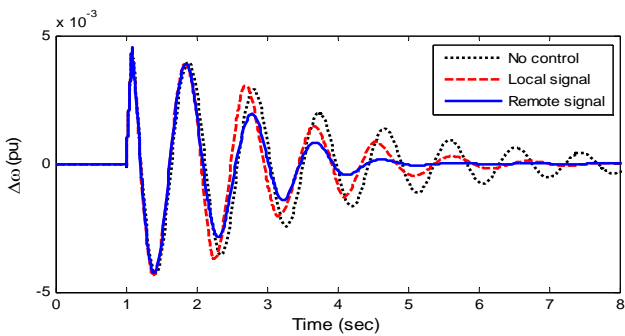

Fig. 9 Speed deviation response for 5 cycle 3-ph fault in transmission line with Light loading

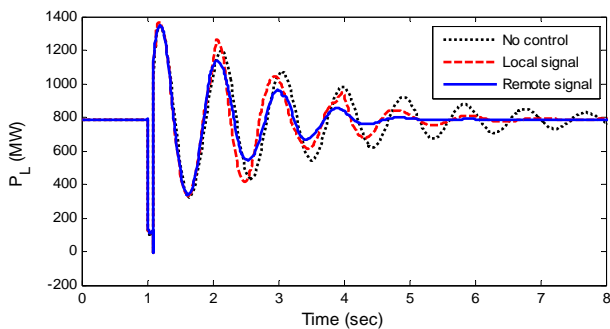

Fig. 10 Tie-line power flow response for 5 cycle 3-ph fault in transmission line with Light loading

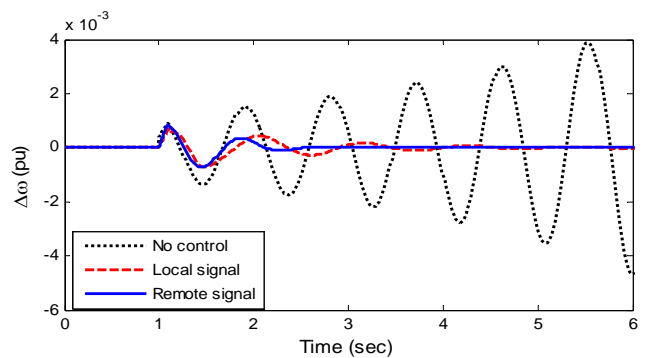

Fig. 12 Speed deviation response for 5 cycle 3-ph fault in transmission line with Heavy loading

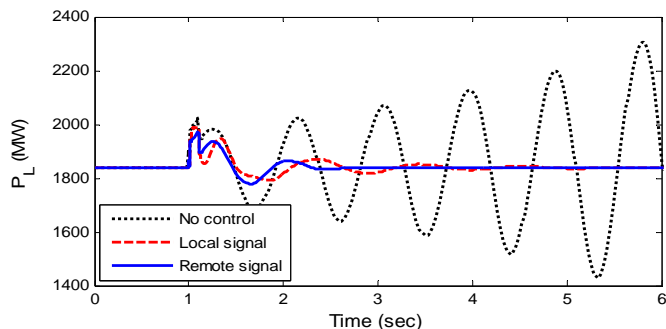

Fig. 13 Tie-line power flow response for 5 cycle 3-ph fault in transmission line with Heavy loading

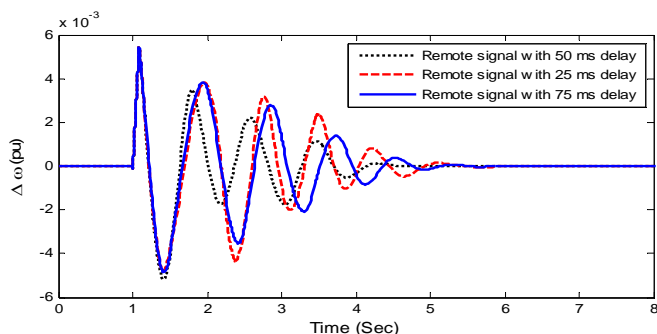

Fig. 14 Speed deviation response showing for case-IV

Case IV: Effect of Signal Transmission Delay

To study the effect of variation in signal transmission delay on the performance of controller, the transmission delay is varied and the response is shown in Fig. 14. In this case, nominal loading condition with 5 cycle, 3-phase, self clearing fault is assumed at the middle of one transmission line for the analysis purpose. It is evident from Fig. 14 that the performances of the proposed controllers are hardly affected by the signal transmission delays.

B. Extension of Multi Machine Power System

The proposed approach of designing and optimizing the parameters of a STATCOM based damping controller is further extended to a multi-machine power system shown in Fig. 15. It is similar to the power system used in references [18], [19], [24], [25]. The system consists of three generators divided in to two subsystems and are connected via an intertie. Following a disturbance, the two subsystems swing against each other resulting in instability. To improve the stability the line is sectionalized and a STATCOM is assumed on the mid-point of the tie line. The relevant data for the system are given in Appendix. For remote input signal speed deviation of generator G1 and G2 is chosen as the control input of STATCOM based damping controller and for local signal real power flow at the nearest bus (bus5) is selected.

The objective functions J is defined as:

$$J = \int_{t=0}^{t=t_{sim}} (\sum |\Delta\omega_L| + \sum |\Delta\omega_I|) \cdot t \cdot dt \quad (8)$$

where $\Delta\omega_I$ and $\Delta\omega_L$ are the speed deviations of inter-area and local modes of oscillations respectively and t_{sim} is the time range of the simulation. The same approach as explained for SMIB case is followed to optimize the STATCOM-based damping controller parameters for three-machine case (i.e. for remote signal a delay of 50 ms has been considered and for local signal the delay is neglected). The best among the 20 runs for both the input signals are shown in Table III.

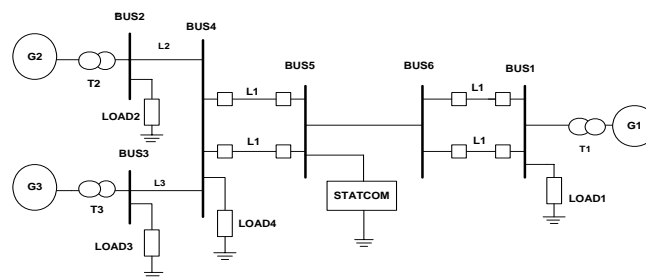

Fig. 15 Three machine power system with STATCOM

A self clearing 3-phase fault is applied near bus 1 at $t = 1$ s. The fault is cleared after 5 cycle and the original system is restored after the fault clearance. Figs. 16-18 show the variations of the inter-area and local mode of oscillation against time respectively for both the control inputs. In these figures the response without control (no control) is shown with dotted line; and responses with local signal for STATCOM-based controllers is shown with dashed line and the same with remote signal is shown with solid line respectively. It is clear from Fig. 16 that inter-area modes of oscillations are highly oscillatory in the absence of STATCOM-based damping controller and the proposed STATCOM-based controller significantly improves the power system stability by damping these oscillations with both local and remote signals. However, remote signal seems to be a better choice compared to the local signal as the power system oscillations are quickly damped out with remote signal.

TABLE III
STATCOM-BASED CONTROLLER PARAMETERS FOR MULTI-MACHINE POWER SYSTEM

Signal/parameters	K_s	T_{1s}	T_{2s}	T_{3s}	T_{4s}
Remote	119.4502	2.0268	1.0102	2.4711	0.2259
Local	156.1155	1.4540	2.3209	1.4506	0.0434

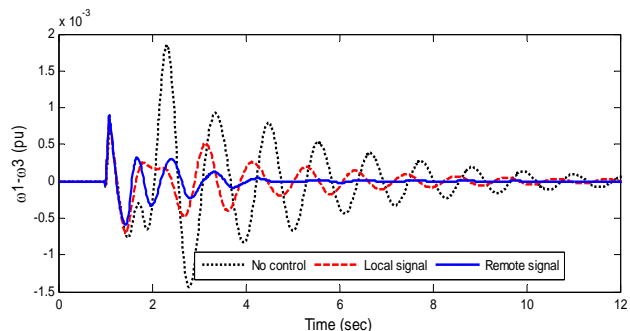

Fig. 16 Inter-area mode of oscillation for 5 cycle 3-phase fault disturbance

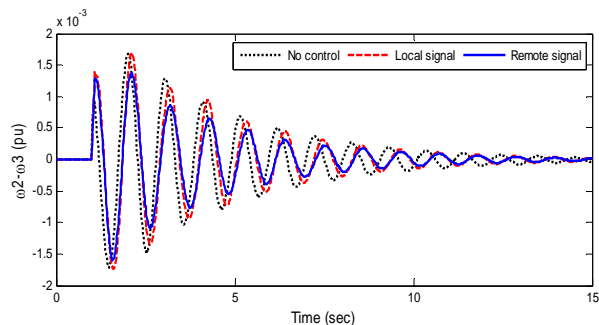

Fig. 20 Local mode of oscillation for line outage disturbance

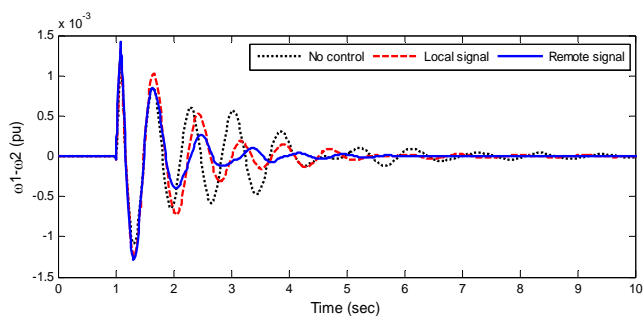

Fig. 17 Local mode of oscillation for self clearing three phase fault disturbance

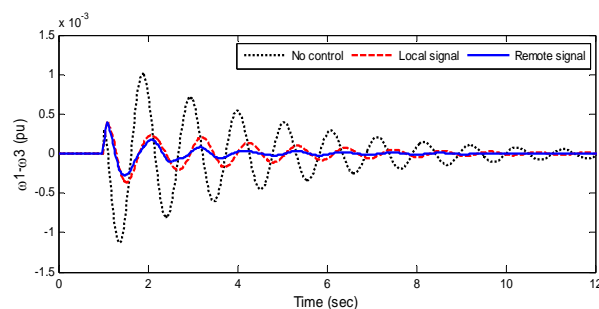

Fig. 21 Inter-area mode of oscillation for small disturbance

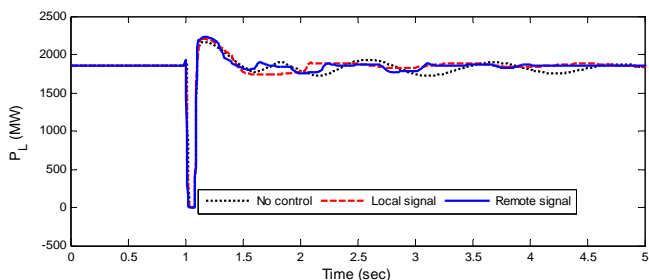

Fig. 18 Tie line power flow for self clearing three phase fault disturbance

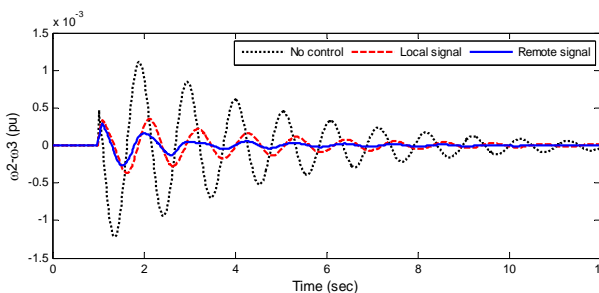

Fig. 22 Local mode of oscillation for small disturbance

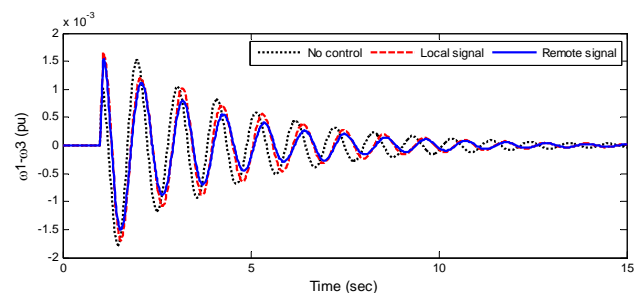

Fig. 19 Inter-area mode of oscillation for line outage disturbance

To show the robustness of the proposed approach, another disturbance is considered. The transmission line between bus 5 and bus 1 is tripped at $t=1.0$ sec and reclosed after 5 cycles. The system response is shown in Figs. 19-20 from which it is clear that local signal is a better choice than remote signal with delay for stability improvement. For completeness, the load at bus 1 is disconnected for 100 ms and the system response is shown in Figs. 21, 22. It is clear from these figures, that the proposed controllers are robust and damps power system oscillations even under small disturbance conditions. Further, the performance with remote speed deviation signal is better than that with local signal.

VI. CONCLUSION

In this study, power system stability improvement by a static synchronous compensator (STATCOM) based damping controller is thoroughly investigated. For the controller design, potential time delays due to sensor time constant and signal transmission delays are considered. The design problem is formulated as an optimization problem, Differential

Evolution (DE) algorithm is employed to search for the optimal controller parameters. The performance of the proposed controller is evaluated under different disturbances for both single-machine infinite bus power system and multi-machine power system using both local and remote signals. Results show that when time delays are considered the proposed approach is better and provides improved performance under various loading conditions and disturbances. It is also observed that from power system stability improvement point of view remote signal is a better choice than the local signal. Additionally, it is observed that the performance of the designed STATCOM-based controller with local signal is hardly affected by the variations in the signal transmission delay.

APPENDIX

System data: All data are in pu unless specified otherwise. The variables are as defined in [18].

(i) Single-Machine Infinite-bus Power System

Generator: $S_B = 2100$ MVA, $H = 3.7$ s, $V_B = 13.8$ kV, $f = 60$ Hz, $R_S = 2.8544 \times 10^{-3}$, $X_d = 1.305$, $X'_d = 0.296$, $X''_d = 0.252$, $X_q = 0.474$, $X'_q = 0.243$, $X''_q = 0.18$, $T_d = 1.01$ s, $T'_d = 0.053$ s, $T_{qo} = 0.1$ s

Load at Bus2: 250MW

Transformer: 2100 MVA, 13.8/500 kV, 60 Hz, $R_1 = R_2 = 0.002$, $L_1 = 0$, $L_2 = 0.12$, D_1/Y_g connection, $R_m = 500$, $L_m = 500$

Transmission line: 3-Ph, 60 Hz, Length = 300 km each, $R_l = 0.02546 \Omega/\text{km}$, $R_0 = 0.3864 \Omega/\text{km}$, $L_l = 0.9337 \times 10^{-3}$ H/km, $L_0 = 4.1264 \times 10^{-3}$ H/km, $C_l = 12.74 \times 10^{-9}$ F/km, $C_0 = 7.751 \times 10^{-9}$ F/km

Hydraulic turbine and governor: $K_a = 3.33$, $T_a = 0.07$, $G_{min} = 0.01$, $G_{max} = 0.97518$, $V_{gmin} = -0.1$ pu/s, $V_{gmax} = 0.1$ pu/s, $R_p = 0.05$, $K_p = 1.163$, $K_i = 0.105$, $K_d = 0$, $T_d = 0.01$ s, $\beta = 0$, $T_w = 2.67$ s

Excitation system: $T_{LP} = 0.02$ s, $K_a = 200$, $T_a = 0.001$ s, $K_e = 1$, $T_e = 0$, $T_b = 0$, $T_c = 0$, $K_f = 0.001$, $T_f = 0.1$ s, $E_{fmin} = 0$, $E_{fmax} = 7$, $K_p = 0$

STATCOM parameters: 500 KV, ± 100 MVAR, $R = 0.071$, $L = 0.22$, $V_{dc} = 40$ KV, $C_{dc} = 375 \pm \mu$ F, $V_{ref} = 1.0$, $K_p = 50$, $K_i = 1000$

(ii) Multi-Machine Power System

Generators: $S_{B1} = 4200$ MVA, $S_{B2} = S_{B3} = 2100$ MVA,

$V_B = 13.8$ kV, $f = 60$ Hz, $X_d = 1.305$, $X'_d = 0.296$,

$X''_d = 0.252$, $X_q = 0.474$, $X'_q = 0.243$, $X''_q = 0.18$,

$T_d = 1.01$ s, $T'_d = 0.053$ s, $T''_{qo} = 0.1$ s, $R_S = 2.8544 \times 10^{-3}$, $H = 3.7$ s, $p = 32$

Transformers: $S_{B1} = 4200$ MVA, $S_{B2} = S_{B3} = 2100$ MVA, D_1/Y_g , $V_1 = 13.8$ kV, $V_2 = 500$ kV, $R_1 = R_2 = 0.002$, $L_1 = 0$, $L_2 = 0.12$, $R_m = 500$, $L_m = 500$

Transmission lines: 3-Ph, $R_l = 0.02546 \Omega/\text{km}$, $R_0 = 0.3864 \Omega/\text{km}$, $L_l = 0.9337 \times 10^{-3}$ H/km, $L_0 = 4.1264 \times 10^{-3}$ H/km,

$C_l = 12.74 \times 10^{-9}$ F/km, $C_0 = 7.751 \times 10^{-9}$ F/km, $L_1 = 175$ km, $L_2 = 50$ km, $L_3 = 100$ km

Loads: Load 1=7500 MW+1500 MVAR, Load 2=Load 3=25 MW, Load 4=250 M

REFERENCES

- [1] N. G. Hingoran, L. Gyugyi, "Understanding FACTS: Concepts and Technology of Flexible AC Transmission Systems", IEEE Press, New York, 2000.
- [2] L. Gyugyi, "Solid-state control of electric power in ac transmission systems," *Int. Symp. Elect. Energy Conv. in Power Syst. Invited paper*, no T-IP 4, 1998.
- [3] L. Gyugyi, "Dynamic compensation of ac transmission lines by solid-state synchronous voltage sources," *IEEE Trans. Power Deliv.*, vol.9, pp. 904 – 911, 1994.
- [4] P. Kundur, *Power System Stability and Control*, New York: McGraw-Hill, 1994.
- [5] K. K. Sen "Static Synchronous Compensator: Theory, Modeling and Applications", *IEEE Power Engineering Society*, pp. 1177–1183, 1999.
- [6] Y. H Song, T. A. Johns, *Flexible AC Transmission Systems (FACTS)*, IEE, London, 2000.
- [7] R. M Mathur, R. K. Verma, "Thyristor-based FACTS Controllers for Electrical Transmission Systems," *IEEE Press, Piscataway*, 2002.
- [8] L. Gyugyi, "Reactive power generation and control by thyristor circuits," *IEEE Trans. Industrial Applications*, vol. IA-15, no.5, pp. 521–532, Sept./Oct. 1979.
- [9] L. Gyugyi, "Power electronics in electric utilities: static var compensators," *IEEE Proceedings*, vol.76, No. 4, pp. 483–494, April 1988
- [10] P. Rao, M. L. Crow, Z. Yang, "STATCOM Control for Power System Voltage Control Application", *IEEE Transactions on Power Delivery*, vol.15, no.4, pp. 1131–1317, Oct.2000.
- [11] T. Hiyama, W. Hubbi and T. H. Ortmeier, "Fuzzy logic control scheme with variable gain for static Var compensator to enhance power system stability," *IEEE Trans. Power Systems*, vol. 14, no. 1, pp.186–191, Feb. 1999.
- [12] M.A. Abido, "Analysis and assessment of STATCOM-based damping stabilizers for power system stability enhancement," *Int. J. Elect. Power & Energy Sys.*, vol.73, pp.177–185, 2005.
- [13] Y. Chang and Z. Xu, "A novel SVC supplementary controller based on wide area signals," *Electric Power System Research*, vol. 77, pp. 1569–1574, 2007
- [14] S. Panda, N.P. Padhy, "Comparison of particle swarm optimization and genetic algorithm for FACTS-based controller design," *Appl. Soft Comput.*, vol.8, pp.1418–1427, 2008.
- [15] S. Panda, et al., "Power system stability improvement by PSO optimized SSSC-based damping controller," *Electr. Power Comput. Syst.*, vol.36, pp. 468–490, 2008.
- [16] S. Panda, N.P. Padhy, "Optimal location and controller design of STATCOM using particle swarm optimization," *J. Franklin Inst.*, vol.345, pp. 166–181, 2008.
- [17] S. Panda, "Differential evolutionary algorithm for TCSC-based controller design," *Simulation Modelling Pract. Theory*, vol. 17, pp.1618–1634, 2009.
- [18] S. Panda, "Multi-objective evolutionary algorithm for SSSC based controller design," *Electr. Power Syst. Res.*, vol.79, pp. 937– 944, 2009.
- [19] S. Panda, "Differential evolution algorithm for SSSC-based damping controller design considering time delay," *J. Franklin Institute*, vol. 348, pp. 1903–1926, 2011.
- [20] R. Stron, K. Price, "Differential evolution—a simple and efficient adaptive scheme for Global Optimization over continuous spaces," *J. Global Optim.*, vol.11, pp. 341–359, 1995.
- [21] L. Eriksson, T. Oksanen, K. Mikkola, "PID controller tuning rules for integrating processes with varying time delays," *J. Franklin Inst.*, vol.346, pp. 470–487, 2009.
- [22] P.L. Liu, "Stabilization criteria for neutral time delay systems with saturating actuators," *J. Franklin Inst.*, vol. 347, pp. 1577–1588, 2010.
- [23] SimPowerSystems4.3User'sGuide. Available from: <http://www.mathworks.com/products/simpower/S>.

- [24] M. Noroozian, et al., "Robust near-optimal control of power system oscillation with fuzzy logic," *IEEE Trans. Power Deliv.*, vol.11, pp.393–400, 1996.
- [25] S. Mishra, et al., "Genetically optimized neuro-fuzzy IPFC for damping modal oscillations of power system," *IEEE Trans. Power Syst.*, vol.17, pp. 1140–1147, 2002.

Sangram Keshori Mohapatra received M.Tech Degree from KIIT, University, Orissa, Bhubaneswar, India in 2008. Presently he is working as an Assistant Professor in the Department of Electrical Engineering, C. V. Raman College of Engineering, Bhubaneswar, Odisha, India. He worked in various reputed organizations for 12 years. His research interest is in the area of Power System Stability, FACTS and Optimization techniques.

Dr. Sidhartha Panda is working as a Professor at VSSUT, Burla (erstwhile UCE, Burla). He received Ph.D. degree from IIT, Roorkee and M.E. degree from UCE, Burla in Electrical Engineering. Earlier he worked in various reputed organizations for 18 years. He has published about 65 papers in various International Journals. His areas of research include MATLAB/SIMULINK, Flexible AC Transmission Systems (FACTS), Modeling of Machines, Power Systems and FACTS, Controller Design, Power System Stability, Genetic Algorithm, Particle Swarm Optimization, Differential Evolution, Multi-objective Optimization, Economic Operation of Power System, Fuzzy Logic, Model Order Reduction, Distributed Generation and Wind Energy.

P. K. Satpathy, obtained his Ph.D. Degree from IIT, Kharagpur in 2003 and M. Tech Degree from IIT, Delhi in 1996 (in the area of Electrical Engineering with specialization in Electric Power Systems). Being a graduate in Electrical Engineering from University College of Engineering, Burla (1989), he joined academics in the year 1990 and has acquired more than 20 years of experience in the field of Academics and Research pertaining to Electrical Engineering. Presently he is positioned as Professor and Head in the Department of Electrical Engineering, College of Engineering and Technology, Bhubaneswar, a premier constituent college of BPUT, Orissa. He has several international publications to his credit. Besides an author of two text books, he is a Member/Fellow/Reviewer of various organizations of National and International repute (Elsevier, IE-India, ISTE, Inpowerg, Interscience).