

# Investigation of the Effect of Cavitator Angle and Dimensions for a Supercavitating Vehicle

Sri Raman A., A.K.Ghosh

**Abstract**—At very high speeds, bubbles form in the underwater vehicles because of sharp trailing edges or of places where the local pressure is lower than the vapor pressure. These bubbles are called cavities and the size of the cavities grows as the velocity increases. A properly designed cavitator can induce the formation of a single big cavity all over the vehicle. Such a vehicle travelling in the vaporous cavity is called a supercavitating vehicle and the present research work mainly focuses on the dynamic modeling of such vehicles. Cavitation of the fins is also accounted and the effect of the same on trajectory is well explained. The entire dynamics has been developed using the state space approach and emphasis is given on the effect of size and angle of attack of the cavitator. Control law has been established for the motion of the vehicle using Non-linear Dynamic Inverse (NDI) with cavitator as the control surface.

**Keywords**—High speed underwater vehicle, Non-Linear Dynamic Inverse (NDI), six-dof modeling, Supercavitation, Torpedo.

$r$	Angular rate with respect to Z axis in body frame (rad/s)
$\bar{R}$	Non dimensional radius of the cavity
$R$	Radius of the cavity (m)
$T$	Thrust (N)
Vol	Volume (m <sup>3</sup> )
$V_\infty$	Free stream velocity (m/s)
$u$	X component of velocity in body frame (m/s)
$v$	Y component of velocity in body frame (m/s)
$w$	Z component of velocity in body frame (m/s)
$W_x$	Component of weight acting in X- direction (N)
$W_y$	Component of weight acting in Y- direction (N)
$W_z$	Component of weight acting in Z- direction (N)
$X_{cg}$	Location of center of gravity from leading edge (m)
$X_{cb}$	Location of center of buoyancy from leading edge (m)
$\bar{x}$	Non-dimensional axial location
$x$	Axial location (m)
$X$	State vector

## NOMENCLATURE

$\alpha$	Angle of attack (deg)
$\alpha_c$	Angle of attack of the cavitator (deg)
$\delta$	Control vector
$\sigma$	Cavitation Number
$\rho$	Density (Kg/m <sup>3</sup> )
$C_D$	Coefficient of drag
$D$	Maximum diameter of the cavity (m)
$d_c$	Diameter of the cavitator (m)
$F$	Force (N)
$Fr$	Froude number
$F_x$	Force acting in X- direction in body frame (N)
$F_y$	Force acting in Y- direction in body frame (N)
$F_z$	Force acting in Z- direction in body frame (N)
$H$	Angular momentum (Nms)
$I_{xx}$	Moment of Inertia about XX axis in body frame (Kg m <sup>2</sup> )
$I_{yy}$	Moment of Inertia about YY axis in body frame (Kg m <sup>2</sup> )
$I_{zz}$	Moment of Inertia about ZZ axis in body frame (Kg m <sup>2</sup> )
$I_{xz}$	Product of Inertia about XZ axis (Kg m <sup>2</sup> )
$L$	Maximum length of the cavity (m)
$m$	Mass (Kg)
$M$	Moment (Nm)
$M_x$	Moment acting about X- axis in body frame (Nm)
$M_y$	Moment acting about Y- axis in body frame (Nm)
$M_z$	Moment acting about Z- axis in body frame (Nm)
$P_\infty$	Free stream pressure (N/m <sup>2</sup> )
$P_v$	Vapor pressure (N/m <sup>2</sup> )
$p$	Angular rate with respect to Xaxis in body frame (rad/s)
$q$	Angular rate with respect to Y axis in body frame (rad/s)

## I. INTRODUCTION

**A**TORPEDO is a self-propelled underwater missile weapon with an explosive warhead, launched above or below the water surface. Most of the torpedoes are propelled under the water by a propeller with an exception of very few torpedoes which are propelled by rocket engines. Since the density of the water is much higher when compared to that of air, the drag experienced by the torpedo is also very high when compared to conventional missile. This demands very high thrust for higher velocities under the water. As we increase the velocity of the torpedo under the water by a suitable propulsion unit, the local pressure on the surface of the torpedo falls below the vapor pressure and this leads to the formation of bubbles which are called the cavities. If we still increase the velocity of the torpedo at the cost of propulsion unit, the size of the cavity begins to grow and at one condition there will be only one bubble which encloses the whole the torpedo. This condition is called supercavitation and is generally achieved by a cavitator. When a supercavity is formed over the torpedo, even though the torpedo cruises in water the torpedo is surrounded by a vapor bubble. Because of this, the actual wetted area of the torpedo reduces and this results in nearly total elimination of skin friction and the overall drag to an order. Due to the reduction in drag, the thrust required to cruise in the supercavitating regime is also reduced. Using this advantage, underwater vehicles can reach very high velocities as cruising in air when the drag reduces in virtue of supercavitation. Supercavitation can still be divided into natural supercavitation and ventilated supercavitation.

M.Tech student, Department of Aerospace Engineering, Indian Institute of Technology Kanpur, Kanpur, India (sriram.aeropsn@gmail.com)  
 Professor, Department of Aerospace Engineering, Indian Institute of Technology Kanpur, Kanpur, India (akg@iitk.ac.in)

Natural supercavitation is achieved while increasing the velocity of the vehicle whereas the ventilated supercavitation is due to the increase in cavity pressure. The cavity pressure in the ventilated cavitation is generally increased by blowing gas behind a sharp trailing edge and the amount of gas which has to be injected is a critical parameter. In this paper we will be dealing only with the cavitation which is formed due to velocity of the vehicle alone.

During the motion of a supercavitating vehicle, its motion dynamics is different than that of normal torpedoes because of the huge reduction in wetted area.

Although there are many research papers which deal with the supercavitation, most of them deal with the shape and stability of the formed cavity with and without ventilation in static cases. LEE Qi-tao *et al* [1] experimentally studied the pitching motion of a supercavitating vehicle in a high speed water tunnel with an emphasis of planing and investigation of loads during the pitching motion. Bálint Vanek [2] in his doctoral thesis explains about control oriented modeling and stability augmentation for supercavitating vehicles. Daijin Li *et al* [3] have theoretically given a control law for motion of the supercavitating vehicles in vertical plane. In this paper we will be discussing the theoretical modeling of naturally supercavitating vehicles at high velocities with particular emphasis on the effect of cavitator dimensions, cavitator angle and the effect of cavitation of fins on the dynamics of the vehicle.

## II. MODELING THE MOTION OF THE SYSTEM

The analysis of physical behavior of any system can be done by mathematical modeling. The vehicle is treated as a rigid body and is having six degrees of freedom in space. The six degrees of freedom in space will result in six equations of motion, in which the inertial forces associated with one degree of freedom, are balanced by the corresponding Aerodynamic/Hydrodynamic and gravity forces.

The reference frame for our analysis is depicted in Fig. 1. From the Newton's second law,

$$\sum \mathbf{F} = \frac{d}{dt}(m\mathbf{V}) \quad \text{and} \quad \sum \mathbf{M} = \frac{d}{dt}(\mathbf{H})$$

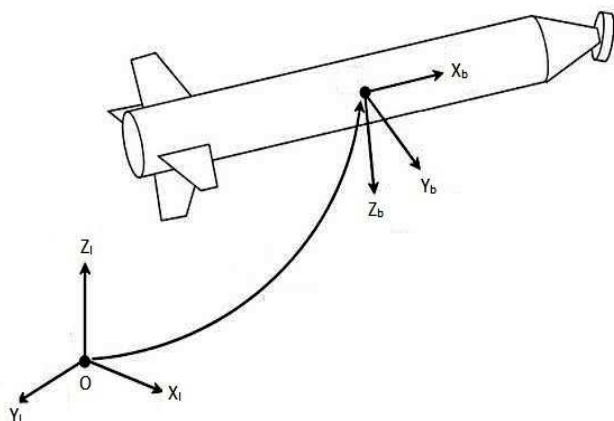

Fig. 1 Reference frame system

The vector equations can be rewritten in scalar form and then consist of three force equations and three moment equations which are coupled in nature.

$$\begin{bmatrix} m & 0 & 0 & 0 & 0 & 0 \\ 0 & m & 0 & 0 & 0 & 0 \\ 0 & 0 & m & 0 & 0 & 0 \\ 0 & 0 & 0 & I_{xx} & 0 & -I_{xz} \\ 0 & 0 & 0 & 0 & I_{yy} & 0 \\ 0 & 0 & 0 & -I_{zx} & 0 & I_{zz} \end{bmatrix} \begin{Bmatrix} \dot{u} \\ \dot{v} \\ \dot{w} \\ \dot{p} \\ \dot{q} \\ \dot{r} \end{Bmatrix}$$

$$= \begin{Bmatrix} F_x + W_x + m(rv - wq) \\ F_y + W_y + m(pw - wq) \\ F_z + W_z + m(rv - wq) \\ M_x + (I_{yy} - I_{zz})qr + I_{xz}pq \\ M_x + (I_{zz} - I_{xx})pr + I_{xz}(r^2 - p^2) \\ M_z + (I_{xx} - I_{yy})pq + I_{xz}qr \end{Bmatrix}$$

The above is the governing equations of motion for any rigid body and the properties mass, inertia; force and moments are measured in the body reference frame. Apart from the above, the three kinematic equations and the three velocity relations between the inertial and body fixed frame is also required to completely solve the initial value problem which governs the motion of any six degree freedom system.

Unlike conventional vehicles, here the force and moment model will be different due to the presence of cavity which will have a considerable effect on the dynamics of the motion.

## III. FORCE AND MOMENT MODELING

The cavitating flows are characterized by the Cavitation number ( $\sigma$ ) and to a small extent they also depend on the Froude Number (Fr). But the dependence on Froude number is basically for the ventilated supercavitation at low velocities. At high velocities natural supercavity forms and the effect of Froude number is negligible and can be ignored.

$$\sigma = \frac{2(P_\infty - P_v)}{\rho V_\infty^2}$$

The supercavitation regime corresponds to very small magnitudes of  $\sigma < 0.1$ . For small depths supercavity forms when the velocity of the vehicle is greater than 50 m/s. Trajectory simulation of such a high speed supercavitating vehicle requires a precise force and moment models and these force and moment models depend on the dimensions of the cavity also. Based on the Riabouchinsky model, Garabedian [4] gave expressions for the drag and cavity dimensions of a supercavitating vehicle.

$$C_D = 0.827(1 + \sigma)$$

$$D = d_c \sqrt{\frac{C_D}{\sigma}} \quad , \quad L = d_c \frac{\sqrt{C_D}}{\sigma} \sqrt{\ln \frac{1}{\sigma}}$$

Reichardt [5] gave a semi-empirical relation to predict the drag and dimensions of the supercavity, which are valid for  $\sigma < 0.1$ .

$$L = D \frac{\sigma + 0.008}{\sigma(0.066 + 1.7\sigma)}$$

$$D = d_c \sqrt{\left(\frac{C_D}{\sigma - 0.132\sigma^{8/7}}\right)}$$

$$\text{Drag} = \frac{\pi}{8} \rho V_\infty^2 D^2 (\sigma - 0.132\sigma^{8/7})$$

Waid [6] also found the expressions for cavity dimensions based on experiments for a ventilated supercavity, which are given by

$$L = \frac{1.08}{\sigma^{1.118}} d_c \quad , \quad D = \frac{0.534}{\sigma^{0.568}} + 1$$

Savchenko *et al* [5] have given the relations for supercavity profile based on water tunnel experiments which is the universally accepted supercavity profile. The results were also validated by ZHANG Xue-wei *et al* [7]. In this paper we will be using this result for calculating the supercavity profile.

$$\bar{R} = (1 + 3\bar{x})^{1/3}, \quad x < 2.0$$

$$\bar{R}^2 = 3.659 + 0.847(\bar{x} - 2.0) - 0.236\sigma(\bar{x} - 2.0)^2, \quad x \geq 2.0$$

Where,

$$\bar{x} = \frac{2x}{d_c} \quad , \quad \bar{R} = \frac{2R}{d_c}$$

Garabedian's result is taken for the calculation of drag for zero angle of attack. But, as the vehicle cruises, the angle of attack keeps on changing until steady state is achieved. When the angle of attack changes the cavity axis also shifts and the entire cavity profile changes as shown in Fig. 2. Because of this the resultant force splits up to give the drag force in the X-direction and a small lift force in the Z-direction. So the effect of angle of attack of the cavitator has to be calculated.

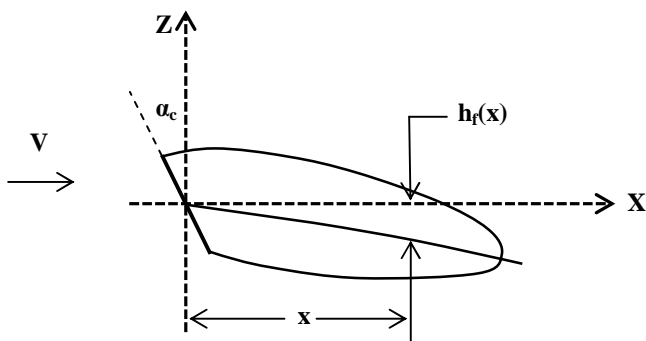

Fig. 2 Deformation of cavity axis due to inclined cavitator

Assuming the motion is in the vertical plane, the component of forces due to the formation of cavity acting on the cavitator disk inclined to the stream with an angle  $\alpha$  can be approximately calculated as [8]

$$F_x = F_{x0} \cos^2(\alpha_c)$$

$$F_z = F_{x0} \sin(\alpha_c) \cos(\alpha_c)$$

Where  $F_{x0}$  is the drag experienced by the cavitator at zero angle of attack. By applying the theorem of momentum,

$$h_f(x) = \frac{-c_z d_c \left(0.46 - \sigma + \frac{2x}{L}\right)}{2}$$

Where,

$$c_z = \frac{8F_z}{\rho V^2 \pi d_c^2}$$

In the supercavitating regime  $F_x$  and  $F_z$  are the additional terms which have to be added. The values of  $F_x$  and  $F_z$  along with other forces due to the fins of the vehicle which extends out of the cavity constitute the entire force model of the vehicle.

Depending upon the fin configuration and the local flow angle, cavities will form over the surface of the fin and the characteristics of the cavity will vary based on the angle of attack experienced by the fin. Computational Fluid Dynamic simulations [9], [10] have shown that partial cavity exists till the angle of attack is 2 degrees and beyond that supercavity evolves.

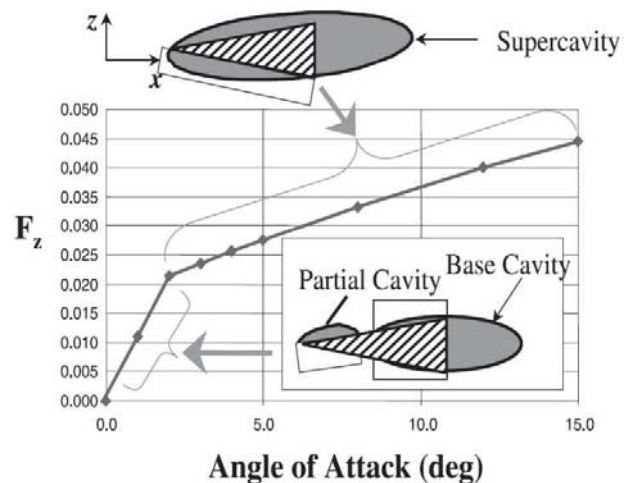

Fig. 3 Variation of fin force. Source : Kirshner [10]

The information from the literature [9], [10] gives us the force coefficients for a specific wedge type fin with some sweep angle. But since the flow is supercavitating the difference in force coefficients between a wedge shaped swept back fin and a flat plate fin will be small and thus the same data has been taken into account for the fin cavitation.

Similarly, the moment generated by  $F_z$  must also be taken into account in the moment modeling. Rests of the moments are same as that of a non-supercavitating vehicle.

regime are given in table II. For the complete supercavitating regime simulation the procedure as explained in section III is followed along with the use of data from table II.

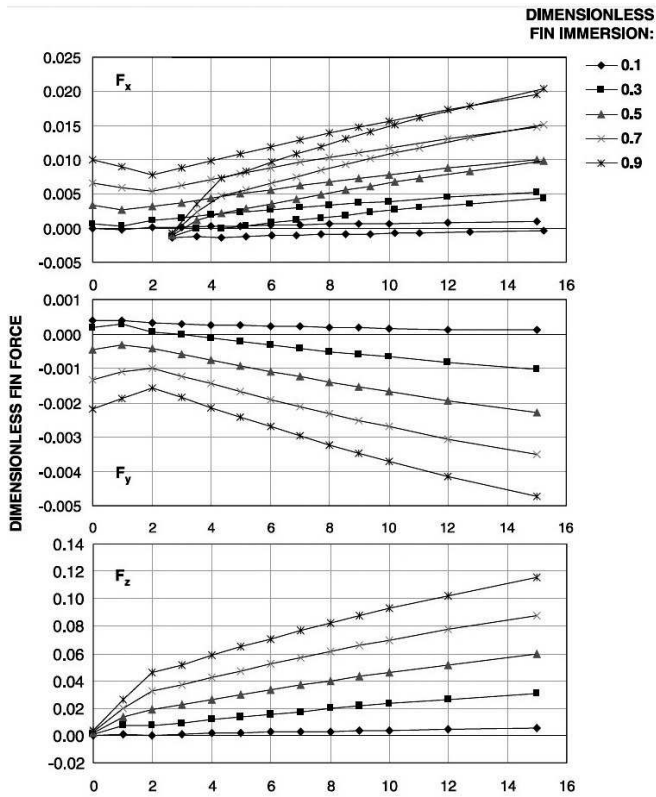

Fig. 4 Variation of fin force coefficients. Source : Kirshner [10]

#### IV. CONFIGURATION OF THE MODEL VEHICLE

The model which is taken into account here as shown in Fig. 5 is a small projectile which is capable of clearing underwater mines up to a depth of 40m. Generally the wall thickness of such a mine will be around 5 mm and calculations have shown that projectiles with a velocity of around 40m/s will have enough kinetic energy to pierce through the mine.

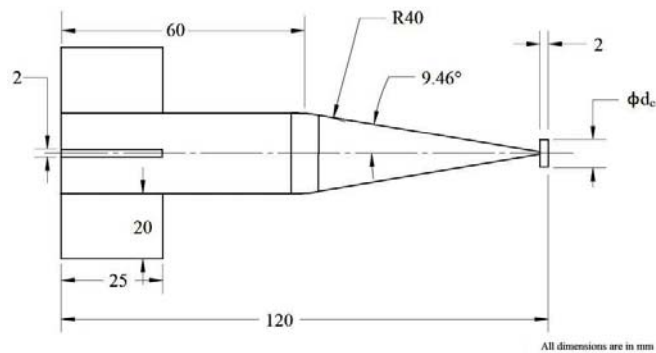

Fig. 5 Configuration of the model vehicle

The mass and inertial properties of the projectile are given in table I. The hydrodynamic parameters which are required for the longitudinal simulation in the non-supercavitating

TABLE I  
STANDARD PROPERTIES OF THE PROJECTILE

Property	Value	Unit
$m$	0.2	Kg
$I_{xx}$	$1 \times 10^{-5}$	$\text{Kg m}^2$
$I_{yy}$	$2.45 \times 10^{-5}$	$\text{Kg m}^2$
$I_{zz}$	$2.45 \times 10^{-5}$	$\text{Kg m}^2$
$I_{xy}$	0	$\text{Kg m}^2$
$I_{xz}$	0	$\text{Kg m}^2$
$Vol$	$2.5132 \times 10^{-5}$	$\text{m}^3$
$T$	100	N
$X_{cg}$ (from L.E)	$7 \times 10^{-2}$	m
$X_{cb}$ (from L.E)	$7.25 \times 10^{-2}$	m

TABLE II  
LONGITUDINAL PARAMETERS REQUIRED FOR THE SIMULATION

Property	Value (non cavitating)	Property	Value (non cavitating)
$Cd0$	0.7351	$CLq$	27.49
$Cda$	0.02	$Cm0$	0
$Cdq$	0	$Cma$	-13.44
$CL0$	0	$Cmq$	-60.13
$CLa$	6.283		

All data are based on fin reference area

It is known from section III that the longitudinal characteristics for the supercavitating regime depends on the cavitation number and the angle of attack. Hence it varies with respect to time and the whole cavity dynamics has been programmed accordingly.

#### V. OPEN LOOP SIMULATION

The outlines of the aforementioned discussions are depicted in Fig.6. The coupled differential equations are solved by the classical Runge-Kutta method in MATLAB®.

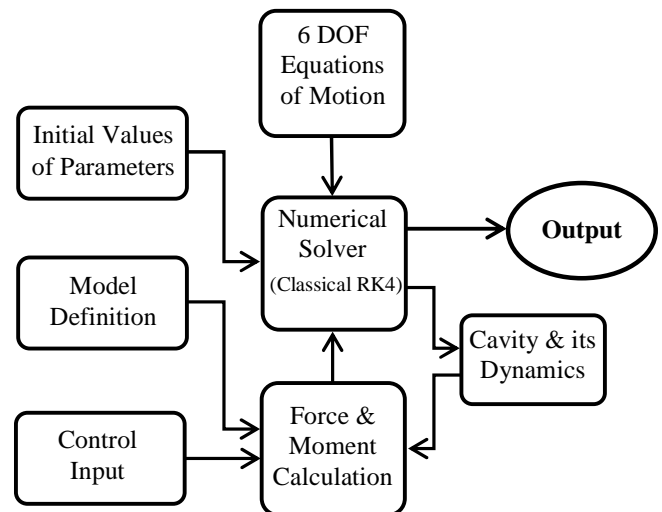

Fig. 6 Schematic of the procedure

Simulations have shown that for the present configuration which is taken into account the minimum diameter of the cavitator comes to be 9 mm for zero cavitator angle of attack. Below which the cavity interacts with the body of the projectile and that leads to distortion of the cavity and the projectile becomes unstable.

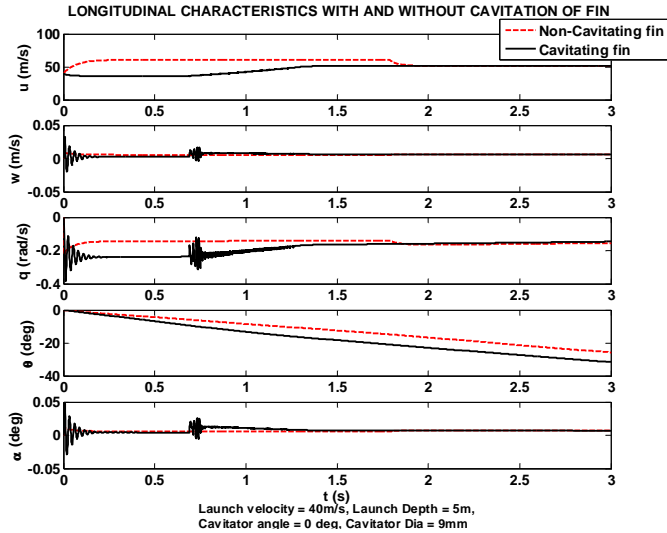

Fig. 7 Comparison of longitudinal characteristics of the vehicle with and without cavitation of fin

On examining the results obtained in Fig. 7, the sudden change in velocity is due to the loss of supercavitation. At this point the projectile will experience a huge impact like drag force of magnitude 50N which is considerably a large force for a projectile of this size. This impact force reduces the velocity of the vehicle and because of this the vehicle comes to the non-supercavitating equilibrium condition. The force experienced by the vehicle due to the loss of supercavitation is an important phenomenon if the vehicle is still allowed to cruise in the non-supercavitating regime.

Drastic changes occur for the angle of attack of the vehicle for the fin cavitating model at the point of loss of supercavitation. A peak in pitch rate is also noticed at this point. This point is like a critical point in which if the missile doesn't have enough thrust to overcome the sudden drag force experienced, it will lead to total instability of the vehicle

Although we concentrate on the design of cavitator, for any supercavitating vehicle stability is achieved by the fins. For complete dynamic stability and control over the projectile, the fins must extend over the cavity. Even though it extends over the cavity, because of high velocities, cavities form over the surface of fins. The trajectory of the projectile is simulated both by including and neglecting the effect of cavitation on fins. The variation of trajectory due to the effect of cavitation of fins is shown in Fig.8.

As mentioned earlier, the emphasis of the present work is to find the effect of cavitator angle of attack and cavitator dimensions on the system dynamics. Fig. 9 best explains the variation of trajectory for various cavitator deflection angles.

Since this projectile is launched from a depth of 5 m, for cavitator angles more than 0.5 degrees, the pitching moment generated consequences the projectile to come out of the water level. So it is evident that with a proper control law we can control the vehicle with cavitator as the only control surface. In Fig. 10, the super cruise velocity sustains for more time for  $d_c=1$  degree than other cavitator angles. So, the cavitator angle also assists in cruising in the supercavitating regime. Also for angles more than 5 degrees the cavity interacts with the body leading to instability of the missile. Using the procedure discussed in this paper, one can design a proper guidance system with cavitator as a control surface rather than conventional control surfaces.

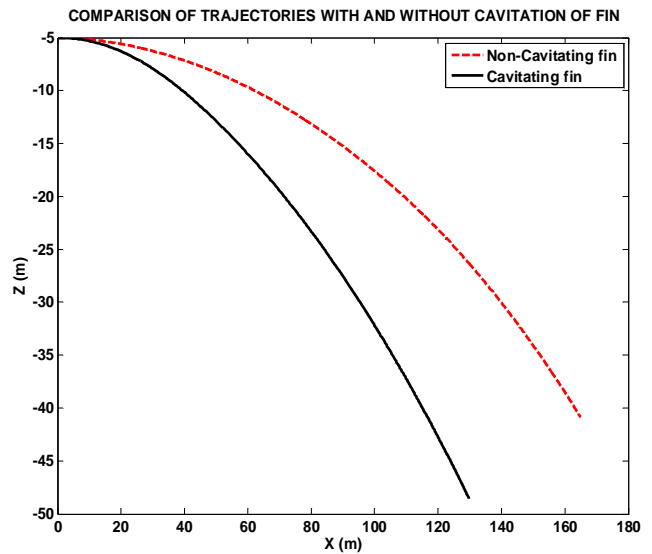

Fig. 8 Variation in trajectory due to fin cavitation

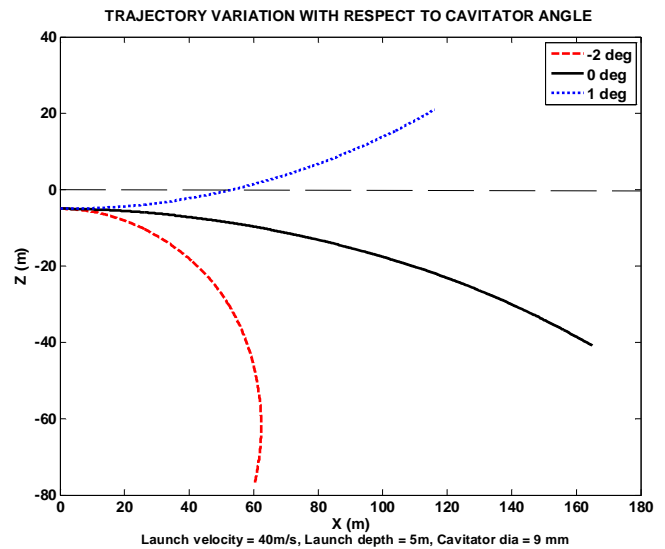

Fig. 9 Trajectory variation with cavitator angle



VARIATION OF TIME HISTORY OF VELOCITY WITH RESPECT TO CAVITATOR ANGLE

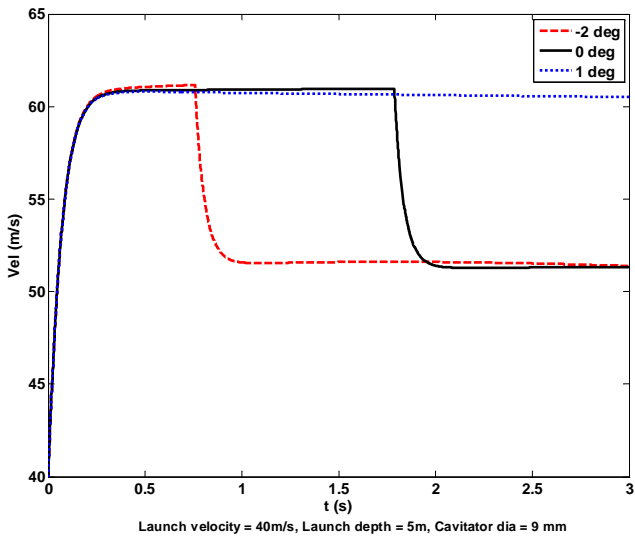

Fig. 10 Effect of cavitator angle on velocity

VARIATION OF TIME HISTORY OF VELOCITY WITH RESPECT TO CAVITATOR DIAMETER

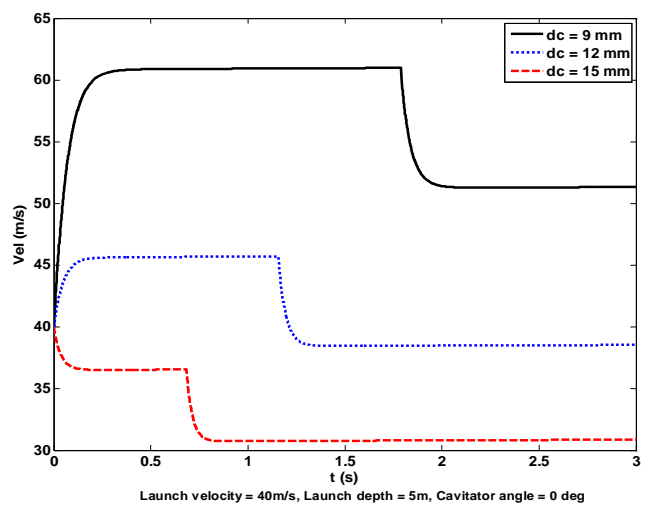

Fig. 12 Velocity variation with cavitator diameter

The next major importance is on the size of the cavitator. It has been observed from Fig.11 that the advantage of cavitator exists only if the size of the cavitator is the minimum size for which it is capable of inducing a full cavity around the whole vehicle. Smaller the size of the cavitator the lesser the drag, but cavitators of size less than 9 mm are unable induce single cavity around the whole vehicle. As we increase the size of the cavitator, the drag also increases thereby reducing the velocity of the vehicle. This causes the cavity to collapse sooner taking the vehicle to the normal non-supercavitating phase. As depicted in Fig. 12 when the cavitator is 12 mm and 15 mm, even though when the projectile is fired at 40 m/s, it is unable to sustain in the supercavitating regime and immediately falls to the normal phase.

TRAJECTORY VARIATION WITH RESPECT TO CAVITATOR DIAMETER

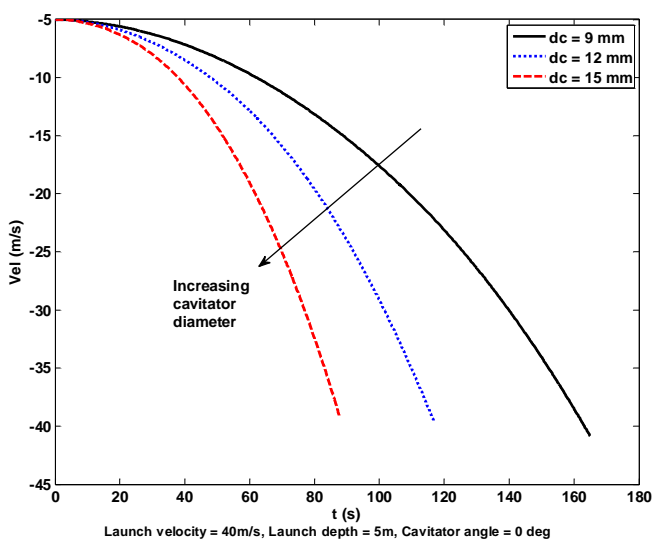

Fig. 11 Trajectory variation with cavitator diameter

## VI. CONTROL LAW USING NDI TECHNIQUE

Non-Linear Dynamic Inverse (NDI) is a control technique which accounts for all the non-linearities present in the system and thus it is one of the best methods to design controllers for highly non-linear systems. The concept of NDI is to generate control signals based on the error signal generated from the desired state and current state received from the feedback. This is achieved by inverting the governing equations for which the states needs to be controlled. In this method, the number of control inputs has to be equal to the number of states which are to be controlled. The states which remain uncontrolled will simply behave like open loop dynamics. If there are many states which depend on one particular input, then only one of any of the states can be controlled.

The governing equations which are described in section I can be written in the state form as

$$\dot{X} = F(X, \delta)$$

This can be written as

$$\dot{X} = f(X) + g(X)\delta$$

Where the  $\dot{X} \in \mathbb{R}^n$  is the state vector includes all the state variables  $\delta \in \mathbb{R}^m$  is the control vector.

The function  $f(X)$  is an  $(n \times 1)$  vector which represents all the non-linear dynamics of the system and  $g(X)$  is an  $(n \times m)$  matrix representing the control distribution function for the state vector ( $m \leq n$ ). Here  $n$  and  $m$  are the number of state variables which can be controlled and number of number of control variables respectively. It has to be noted that  $g(X)$  has to be invertible for this NDI to be implemented. This makes clear that  $g(X)$  has to be square which further implies that the number of states which can be controlled is equal to number of control variables.

At first, the state equation is inverted as follows,

$$\delta = g(X)^{-1}[\dot{X} - f(X)]$$

Although it looks simple in inverting, if the dimensions of  $g(X)$  matrix increase, then singularities might arise during inversion and it has to be taken care while modeling the system. After inversion the control required for the state to be controlled is found by replacing the inherent(or actual) dynamics with the desired dynamics.

$$\delta_{des} = g(X)^{-1}[\dot{X}_{des} - f(X)]$$

Where

$$\dot{X}_{des} = K_P(X_{des} - X_{act})$$

Here  $(X_{des} - X_{act})$  is the error signal and  $K_P$  is the proportional controller gain. Here only the proportional controller is used, but the other controllers, differential or integral or their combination may also be used and their effect will be reflected in the system performance. A simplified block diagram of control algorithm is shown in fig. 13.

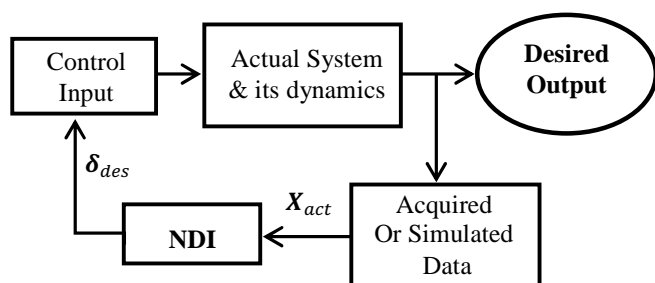

Fig. 13 Schematic of the control system

The prime advantage of the supercavitating vehicles are to maintain the cavity around them which will help in cruising with less thrust when compared to conventional torpedoes. So the objective of the control system designed is to keep the flow supercavitating, i.e., the cavitation number ( $\sigma$ ) has to be maintained below 0.1. This can be achieved by either controlling the velocity or by maintaining the depth so that the hydrostatic pressure ( $P_e$ ) is less. Since the hydrostatic pressure increases tremendously with depth, it is undesirable to control the velocity to keep the cavitation number below the limits. So here the depth is maintained by controlling the pitch angle.

As seen in Fig. 14, the cavimator deflection required to maintain the pitch angle of 0 degrees is around 0.4 degrees, which is reasonably a good value and the rate at which the controller has to deflect is also very less since the cavimator deflection curve is smooth. Also, from the obtained results one can observe that the 9mm cavimator has given good performance when compared to the 12mm cavimator. This again validates the statement “the advantage of the cavimator exists only if its size is minimum enough to induce a single cavity around the vehicle”, and is true for the control also.

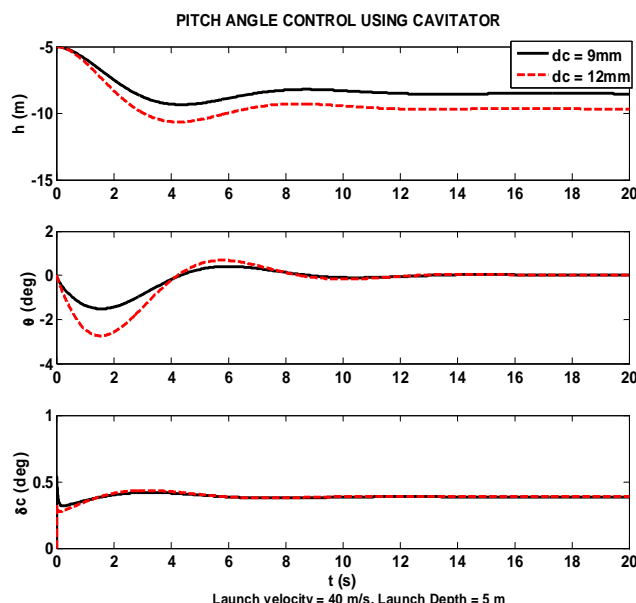

Fig. 14 Pitch angle control using cavimator

## VII. SUMMARY AND FUTURE WORK

The mathematical model for the analysis of longitudinal characteristics of a supercavitating vehicle is developed and is used for the analysis of the effect of cavimator angle of attack and dimensions on the system dynamics. The variation of states due to the cavitation of fin has been figured out and the trajectory variation is well explained.

For every supercavitating vehicles there exists a cavimator of minimum diameter which is capable of inducing a single cavity over the vehicle. Only at this condition the performance of the supercavitating vehicle will be maximum.

It has been found that cavimator can play a pivotal role in the control of supercavitating vehicles, since its effect on the trajectory due to the variation of its angle and dimensions are considerable. Control law established using the NDI technique has shown that a naturally supercavitating vehicle can be controlled with cavimator as the only control surface.

The idea of this paper can be extended to formulate a design algorithm to optimally design the size of the cavimator for a particular vehicle configuration to achieve maximum performance.

## ACKNOWLEDGMENT

The authors would like to thank the Naval Research Board, India for their grateful support and assistance to carry out the research.

## REFERENCES

- [1] LEE Qi-tao, XUE Lei-ping, HE You-sheng, “Experimental study of ventilated supercavities with a dynamic pitching model,” *Journal of Hydrodynamics*, 2008, 20(4): pp. 456-460.
- [2] Bálint Vanek, Control methods for high speed supercavitating vehicles, Ph.D Thesis, University of Minnesota, 2008.
- [3] Daijin Li, Yuwen Zhang, Kai Luo&Jianjun Dang, “Motion Control of Underwater Supercavitating Projectiles,” *Modern Applied Science*, 2009, Vol 3, No.2, pp. 60-65.
- [4] Garabedian, P.R., “Calculation of axially symmetric cavities and jets,” *Pac. J. Math.*, 1956, 6, No. 4, pp. 611-684.

- [5] Vladimir N.Semenenko - Artificial Supercavitation – Physics and Calculations – DTIC, ADP012080.
- [6] Travis Jon Schauer., An Experimental study of ventilated supercavitating vehicle, M.S. Thesis, University of Minnesota, 2003.
- [7] ZHANG Xue-wei, WEI Ying-jie, ZHANG Jia-zhong, WANG Cong, YU Kai-ping, “Experimental research on the shape characteristics of natural and ventilated supercavitation,” *Journal of Hydrodynamics*, Ser.B, 2007,19(5): pp. 564-571.
- [8] Birkhoff, G.,Zarantonello, E.H.,*Jets, Wakes and Cavities*, Academic Press Inc. Publishers,New York, 1957.
- [9] A. J. Kurdila, R. Lind, J. Dzielski, A. Jammulamadaka, and A. Goel, “Dynamics and control of supercavitating vehicles,” Office of Naval Research - Supercavitating High speed bodies, Tech. rep. 2003.
- [10] Ivan N. Kirschner, David C. Kring, Ann W. Stokes, Neal E. Fine and James S. Uhlman, Jr, “Control strategies for supercavitating vehicles,” *Journal of Vibration and Control*, 2002, Vol 8, No.2, pp. 219-242.
- [11] Lane S.H., Stengel R.F., Flight Control Design using Nonlinear Inverse Dynamics, *Automatica*, Vol.24,1988, pp. 471-483
- [12] Knapp, R.T., Daily J.W., Hammitt, F.G., *Cavitation*, McGraw-Hill, New York, 1970.
- [13] Franc.J.P.,Michel.J.M., *Fundamentals of Cavitation*, Kluwer Academic Publishers, Dordrecht, 2004.
- [14] Nelson, *Flight Stability and Automatic Control*, Tata McGraw Hill, New Delhi, 2007.
- [15] Tewari, A., Modern Control Design with Matlab and Simulink, John Wiley and Sons Ltd, Kundli, 2003.
- [16] Logvinovich.G.V., Hydrodynamics of free boundary flows, IPST Press, Jerusalem, 1972.
- [17] Vladimir N.Semenenko., *Fundamentals of calculation and designing the underwater supercavitating vehicles*, Special Lecture course, Institute of hydromechanics, National Academy of sciences of Ukraine.
- [18] Davies.T.V., Steady two dimensional cavity flow past an aerofoil using linearized theory. *Quarterly Journal of mechanics and applied mathematics*,VolXXIII,Part 1, 1970.
- [19] David R. Stinebring, Michael L. Billet, Jules W. Lindau, Robert F. Kunz - Developed Cavitation-Cavity Dynamics– DTIC, ADP012075.
- [20] Santosh Kumar Burnwal, Modeling& Simulation of High Speed Supercavitating Vehicle, M.Tech Thesis, Indian Institute of Technology Kanpur, 2011.
- [21] “Supercavitating flows”, RTO EN-010/AVT-058, January 2002.
- [22] Selected lecture notes on “*Ship Hydrodynamics*” course, Faculty of Naval architecture and Ocean Engineering, Istanbul Technical University.
- [23] Selected Lecture notes on “*Performance of marine vehicles at sea*”, Dept. of Ocean engineering and Naval Architecture, IIT Kharagpur.