

Electronic System Design for Respiratory Signal Processing

C. Matiz C., N. Olarte L., and A. Rubiano F.

Abstract—This paper presents the design related to the electronic system design of the respiratory signal, including phases for processing, followed by the transmission and reception of this signal and finally display. The processing of this signal is added to the ECG and temperature sign, put up last year. Under this scheme is proposed that in future also be conditioned blood pressure signal under the same final printed circuit and worked.

Keywords—Conditioning, Respiratory Signal, Storage, Teleconsultation.

I. INTRODUCTION

FOR many years there have existed extensive technological developments for obtaining a proper capture and interpretation of different types of physiological measures. Although there are wide studies, designs and developments in the area of signal processing and storage, these currently have a series of drawbacks. For example, techniques used to capture the signals, interpretation of data computer as it require to be as accurate as possible, and the safety and regulation parameters to implement, regarding the patient information.

In the case of the respiratory signal, we must take into account different aspects. This includes implementing a non-invasive technique as possible, as well as the detailed description of its waveform, in order to treat process and analyze it.

Initially breathing is defined as the process by which living organisms absorb and expel air [1]. For this reason the signal has different characteristics in its shape, among them we have to take into account the inspiratory and expiratory time, which allows us to see the high and low times [2]-[3].

This work is being carried out within the Telemedicine Research Group of the Military University (TIGUM), as a subsequent stage, for the processing of the temperature and the ECG signal conditioned within the project "System storage of biological signals with remote access and security settings", conducted in 2011 [4]-[5].

Treatment of this type of biological signal will also include its storage within a platform for later viewing, along with the user authentication to protect the patient information.

A. Justification

Currently there are different methods for the acquisition of the respiratory signal in the field the signal processing, but in specifically, this signal, in telemedicine has some disadvantages, for proper viewing this because of physiological measure may be affected by external noise such as the electric network, noise from the other devices and even the skin contact with the electrodes the study of the different methods of treatment of the signal, was chosen from ECG signal, previously treated

Without invasive for the methods mentioned we used the Fluke PS420 patient simulator, which generates four biological signals: temperature, blood pressure, ECG, and respiration signal of interest. This patient may be seen in the following Fig. 1. It also allows nine frequency settings which can simulate the characteristics of the respiratory signal [4]-[5].

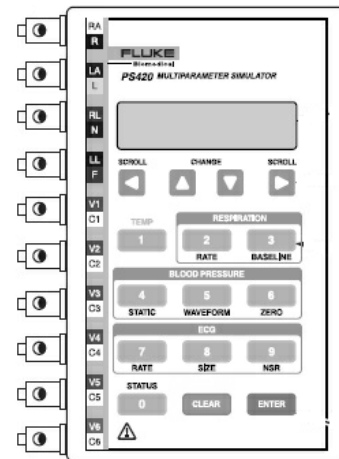

Fig. 1 Fluke PS420 Multiparameter Simulator [6]

B. Background

The waveform of the respiratory signal has different frequency components. Therefore its characteristics vary as shown in the following Fig. 2:

F. Cesar Matiz. is with the "Nueva Granada" Military University, Electronics and Communications Technology student, Bogotá, Colombia (phone: 6500000 Ext 1295; e-mail: u1701177@unimilitar.edu.co).

Nancy Olarte is with the "Nueva Granada" Military University, Auxiliar researcher, Bogotá, Colombia (phone: 6500000 Ext 1295; e-mail: nancy.olarte@unimilitar.edu.co).

Astrid Rubiano is with the "Nueva Granada" Military University, Teaching researcher, Bogotá, Colombia (phone: 6500000 Ext 1295; e-mail: astrid.rubiano@unimilitar.edu.co).

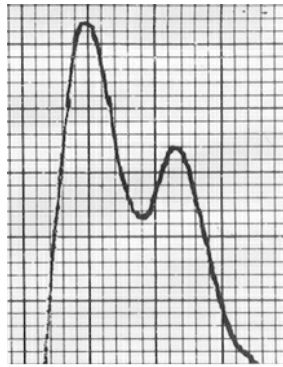

Fig. 2 Waveform respiratory of signal [7]

The main wave is characterized by the inflation and deflation which depends on the respiratory rate. But this rate depends on the patient's heart rhythm. These features modify the waveform depending on the conditions as well as the frequency, according to the waveform characteristic.

Within several studies previously made the relationship between the respiratory signal and the cardiac signal has been known. This is because the patient breathing could be affected due to the fact that either some of them develop symptoms of cardiac abnormalities or due to changes experienced by the heart. Also, breathing is affected if the heart frequency raises or lowers. [8]- [9]-[10]

As mentioned above, there are different types of breathing abnormalities some of these related to the heart some of these anomalies are: [11]

C. Respiratory Sinus Arrhythmia

Is normal in slowing heart rate during expiration and acceleration of the same inspiration [12].

Apnea: Absence of breathing for a period of 20 seconds [13]

Obstructive apnea: Absence until 90% of duration until 10 seconds. [13]

Hypopnea: Discernible reduction between 30% and 90% [13]

Tachypnoea: Respiratory frequency above 20 breaths per minute. [14]

Bradypnea: Frequency respiratory less than 12 breaths per minute.[14]

Dyspnoea: Patient's subjective feeling of difficulty breathing or effort [14]

II. PROPOSED DESIGN

In order to obtain a correct display of bio signals such as the respiratory signal and the ECG signal, it must be considered several key issues such as the signal acquisition, pre-processing (conditioning), and processing. This is to integrate a further platform with access and storage remote. For this we took into account previous research as prior art, for the treatment of physiological signals, by comparing different methods and techniques.

The following will describe the methodology that was implemented for the conditioning of the respiratory signal. It

was taken initially into account that the signal was from another bio signal, such as the ECG in order to carry out the design of the circuit.

A. Methodology

The design of this circuit is essentially based on four phases which are (See Fig. 3):

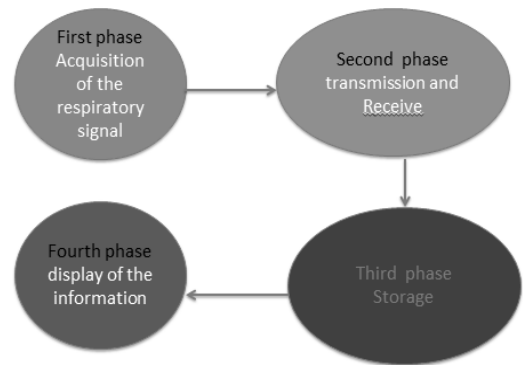

Fig. 3 Methodology

The following will describe each of them:

B. First Phase: Respiratory Signal Acquisition

For this phase was taken into account the acquisition module pre-processing, processing of the respiratory signal which described in the following stages (See Fig. 4):

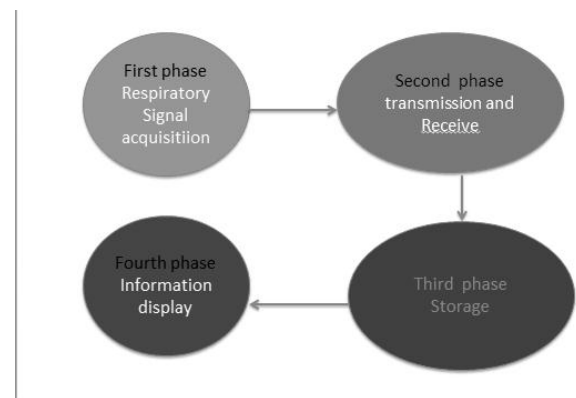

Fig. 4 Acquisition module

Acquisition module: For this was used the Fluke PS420 Multiparameter Simulator which was chosen as it provides the sufficient conditions its derivations, to perform simulations of the respiratory signal and ECG. [15]

Pre-processing module: This is the module for signal conditioning, the design takes in account the implementation of instrumentation amplifiers, in our case the AD620, by its wide use and high-gain in electrocardiography and thereby seeking to treat the waveform from respiratory signal, from the ECG signal, for this was handled design which includes amplification and filtering stages, like may see in the order of figures (Fig. 5, Fig. 6 and Fig. 7).

Amplification: In this stages was used the operational amplifier JFET TL084CN, for its low power consumption, and the instrumentation amplifier AD620 as it provide a infinite input impedance, both derivations from de respiration signal, it arrive at this amplifier like it see in the next Fig. 5.

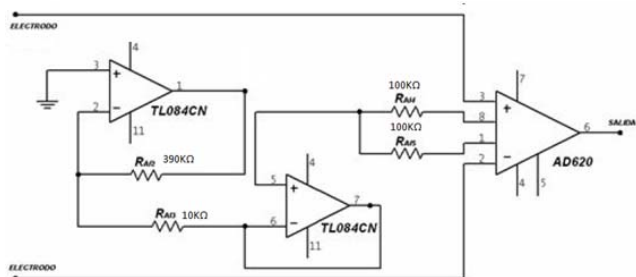

Fig. 5 Amplifier circuit

Filtered this stage delete unwanted noise from different sources. The sequence of the filters in the order was: High pass filter and Low pass filter, as shown in the following Fig. 6 and Fig. 7, also using the JFET TL084CN operational.

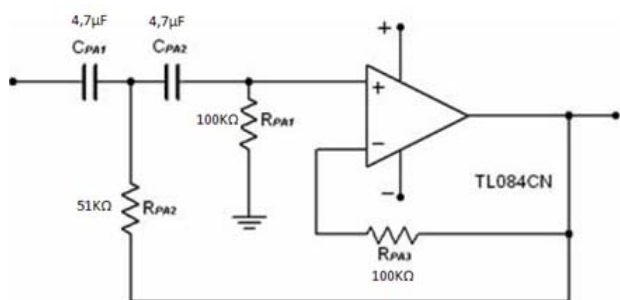

Fig. 6 High pass filter

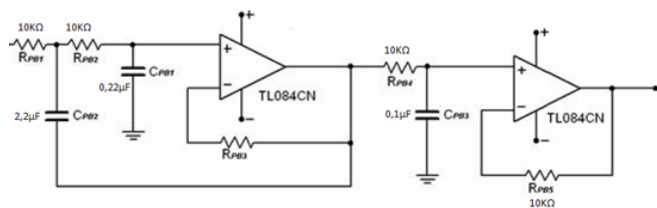

Fig. 7 Low pass filter

Processing module: program and used the microcontroller ATMEGA16A the which adapts to the conditions needed to the circuit implementation, also converts the respiratory signal from analog to digital. Generate bit frames also binds with the phase 2 to the project.

The following phases 2, 3 and 4 already been implemented during 2011 will be describe briefly below:

III. PHASE 2: TRANSMISSION AND RECEPTION MODULE

It was selected to the standard RS232 for serial communication of data to computer with the circuit MAX232, which became the voltages 0V to 5V TTL levels

microcontroller 12V - 12V, finally used the DB9 male 9-pin, which devices are connected to the serial port. [15].

IV. PHASE 3: STORAGE

This phase was implemented in entry form and to data modification is a centralized system. The access to information is effected through authentication to a server based on specific knowledge to a user name, key and the answer a one secret question [15]

V. PHASE 4: INFORMATION DISPLAY

Finally this phase was worked through a platform designed for work in a web environment.

To facilitate the access to the information from a in the place which is the user requiring only a computer with to internet access and a web browser. The design let viewing more signals (respiration, temperature or ECG) while, after storing them for future evaluation of the specialist results. [15].

VI. RESULTS

Below are disclosed the results of the total final design of the printed circuit with its different modules for processing of more biological signals the final printed circuit be appreciated in following Fig. 8, is compatible with the voltage and impedance levels that has the patient fluke- PS 420 although they are performing the final testing of the circuit of conditioning of the respiratory signal there a space to the final circuit.

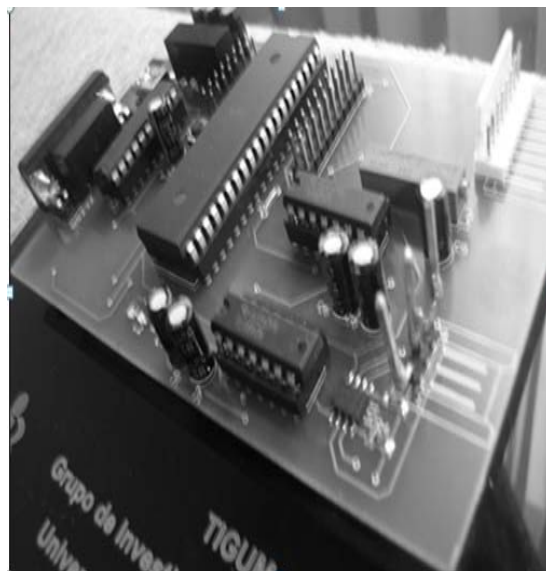

Fig. 8 Final printed circuit board

They underwent the printed circuit design software Eagle. It was taken into account as two layers; the first one is discrete componentes and the second one is surface components such as resistors together with all their routes.

This final printed circuit is portable and small, approximately 12 cm x 8 cm, also in the following Fig. 9 shows that the entry of the signals generated by the patient PS Fluke 420 are located on the right (ECG, temperature and respiration), followed by the steps of conditioning, signal processing and transmission and reception by RS-232 (DB 9) to the PC and USB communication.

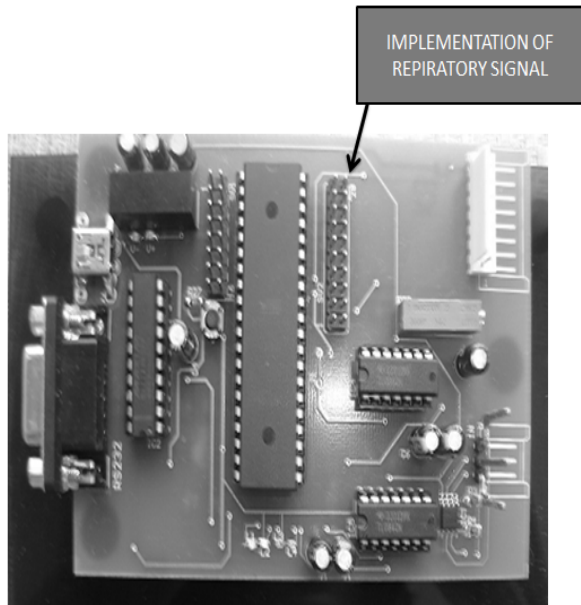

Fig. 9 Final location respiratory signal circuit

VII. CONCLUSION

From the ECG signal conditioning is work treating the waveform of the respiratory signal, since within the premises of the university has a patient simulator that generates the signals among others, providing for both signals, the same baseline impedance 500Ω, 1000Ω, 1500Ω and 2000Ω for leads I and III of the patient.

The final prototype transmitter and receiver to add more protocols and communication technologies, as well as future roadmap for projects wishing to implement more security parameters, or also use other platforms or programming languages.

The final printed circuit has USB power also does not need a dual source because it contains a voltage regulator that derives -5V and 5V.

Another project, in addition to the three signal conditioning and treated (ECG, temperature and respiration) is the signal processing Blood Pressure, which also generates the patient, and has additional space for its final implementation in printed circuit end.

REFERENCES

- [1] <http://minerva.uca.es/publicaciones/asp/docs/tesis/DSanchezMorillo.pdf>, consulted June 04th 2012.
- [2] <http://www.dm.unibo.it/~ferri/hm/pubbl/Respiratory.pdf>, consulted: March 22th 2012.

- [3] <http://minerva.uca.es/publicaciones/asp/docs/tesis/DSanchezMorillo.pdf>, consulted: February 03th 2012.
- [4] <http://www.angelfire.com/journal2/johnagomez/Tgrado.pdf>, consulted: February 29th 2012.
- [5] <http://upcommons.upc.edu/pfc/bitstream/2099.1/8081/1/PFC.pdf>, consulted: April 04th 2012.
- [6] Fluke Biomedical PS420 Multiparameter Simulator: Manual de Uso, 2006 – 2007 Fluke Corporation, p. 9.
- [7] <http://www.the-respiratory-pulse.org.ve/experien.htm>, consulted: April 18th 2012.
- [8] http://eciencia.urjc.es/bitstream/10115/5599/1/PFM_LeticiaTalavera.pdf, consulted: May 08th 2012.
- [9] <http://www.usc.es/~catelmed/2005/materialAsignatura/AdquisicionSenalesBiologicas.pdf>, consulted: May 08th 2012.
- [10] <http://www.wordreference.com/definicion/respiraci%C3%B3n>, consulted: June 04th 2012.
- [11] <http://es.sott.net/articles/show/10504-Eiriu-Eolas-Expansion-del-conocimiento>, consulted: May 23th 2012
- [12] <http://www.wordreference.com/definicion/respiraci%C3%B3n>, consulted: June 04th 2012.
- [13] <http://dSPACE.espace.edu.ec/bitstream/123456789/625/1/38T00239.pdf>, consulted May 31th 2012.
- [14] <http://www.dalcame.com/wdescarga/manejo%20msv.pdf>, consulted:
- [15] A. Rubiano F, N. Olarte and D. Lara Design of medical information storage system – ECG signal” (paper) pp. 2-3, consulted: June 12th 2012.