

# Heat Stress Monitor by using Low-Cost Temperature and Humidity Sensors

Kiattisak Batsungnoen, and Thanatchai Kulworawanichpong

**Abstract**—The aim of this study is to develop a cost-effective WBGT heat stress monitor which provides precise heat stress measurement. The proposed device employs SHT15 and DS18B20 as a temperature and humidity sensors, respectively, incorporating with ATmega328 microcontroller. The developed heat stress monitor was calibrated and adjusted to that of the standard temperature and humidity sensors in the laboratory. The results of this study illustrated that the mean percentage error and the standard deviation from the measurement of the globe temperature was 2.33 and 2.71 respectively, while 0.94 and 1.02 were those of the dry bulb temperature, 0.79 and 0.48 were of the wet bulb temperature, and 4.46 and 1.60 were of the relative humidity sensor. This device is relatively low-cost and the measurement error is acceptable.

**Keywords**—Heat stress monitor, WBGT, Temperature and Humidity Sensors.

## I. INTRODUCTION

At present, the dangers from working in high-temperature working environment are considered to be a big problem to workers' health and sanitation [1, 2, 3]. It leads to many problems: fever, fatigue, dehydration, cramp, faint, and even death in some severe cases [4, 5]. Thus, The Ministry of Labor has given importance to the safety of workers working in high-temperature environment by issuing a ministerial regulation to regulate the administration and management in safety, health and working environment concerning heat, light and noise. This regulation stipulates that every company must check the heat, light and noise in their working environment at least once a year or every time there is a change in production process, machine or equipment. If the heat level is higher than the standard score specified, the company must find a way to control the heat to the safe level [6, 7]. However, current WBGT heat stress monitors are expensive, so it is difficult to measure environments and prevent dangers from working in time. We realized the significance of this problem; therefore, we developed a cheap WBGT heat stress monitor which can measure the heat level precisely, has low measurement errors, and can be made from materials available in Thailand. This monitor will be a viable alternative for companies to improve health, safety and working environment in the future. The wet bulb globe temperature (WBGT) index is the most widely used and accepted index for the assessment of heat stress in

K. Batsungnoen is with the School of Occupational Health and Safety, Institute of Medicine, Suranaree University of Technology, Nakhon Ratchasima, 30000 Thailand. (e-mail: batsungnoen@hotmail.com).

T. Kulworawanichpong is with the School of Electrical Engineering, Suranaree University of Technology, Nakhon Ratchasima, Thailand (e-mail: thanatch@sut.ac.th).

industry. It represents the heat stress to which an individual is exposed. The WBGT-index combines three measurements [3]:

- Natural wet-bulb temperature ( $t_{nw}$ )
- Globe temperature ( $t_g$ )
- Air temperature ( $t_a$ )

The following illustrates the relationship between the different measurements.

Inside buildings and outside buildings without experiencing the effects of radiation from the sun:

$$WBGT_{\text{indoor}} = 0.7t_{nw} + 0.3t_g$$

Outside buildings with solar load, or where a radiant heat source is present indoors:

$$WBGT_{\text{outdoor}} = 0.7t_{nw} + 0.2t_g + 0.1t_a$$

The measurements are entered into the above the equations to obtain a WBGT value. The WBGT value is then compared to the reference values provided in the standard for the appropriate metabolic rate and state of acclimation of the worker.

## II. MATERIALS AND METHODOLOGY

This paper describes the development of a cheap WBGT heat stress monitor which can measure the heat level precisely with low measurement error.

### A. Study Design

This study was an experimental study for creating a WBGT heat stress monitor. This process connected SHT15 and DS18B20 temperature/humidity sensors to ATmega328 microcontroller [8]. The state of the microcontroller was shown on LED display circuit. Sensor Monitoring program created from Microsoft Visual C# then read out the temperature and humidity values from the WBGT heat stress monitor. The results could be seen on an LCD screen

### B. Materials and Instrument

- Temperature / humidity sensors SHT15
- Temperature / humidity sensors DS18B20
- Microcontroller ATmega328
- LCD Display
- Microsoft Visual C# Program
- Sensor Monitoring Program
- Multi-purpose box (14cm high, 15cm wide, thick, 6.5cm).
- Copper metal sphere on a black opaque
- Standard Heat stress monitor WBGT

*C. Study Method*

*C1) Function of WBGT heat stress monitor*

When the monitor was turned on, the LED tube light would lighten to show that the microcontroller was working. Then, SHT15 and DS18B20 temperature/humidity sensors would send input from the system to be processed in the microcontroller. Sensor Monitoring program created by using Microsoft Visual C# read the temperature and humidity values from the WBGT heat stress monitor [9, 10,11]. The results are sent to be displayed on the LCD screen. The function and components of the WBGT heat stress monitor can be summarized in Fig. 1 and 2, respectively.

1. Place a standard WBGT heat stress monitor and the created one in the same position
2. Measure humidity and the heat level of all three types of the thermometer in a laboratory which has normal temperature, and humidity.
3. Read out the temperature and humidity values from the monitor and then use them to draw a graph
4. Find the relation between a standard WBGT heat stress monitor and the created one
5. Check and adjust the developed WBGT heat stress monitor to the standard one and then repeat the experiment

*C2) Method of Experimentation*

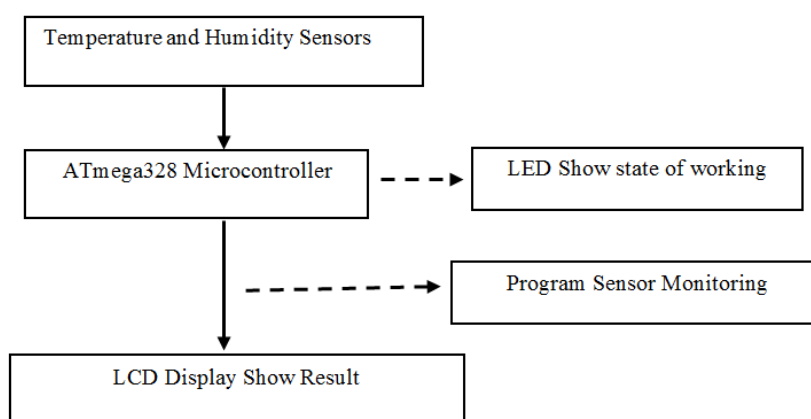

Fig. 1 Flow diagram of the heat stress monitoring process

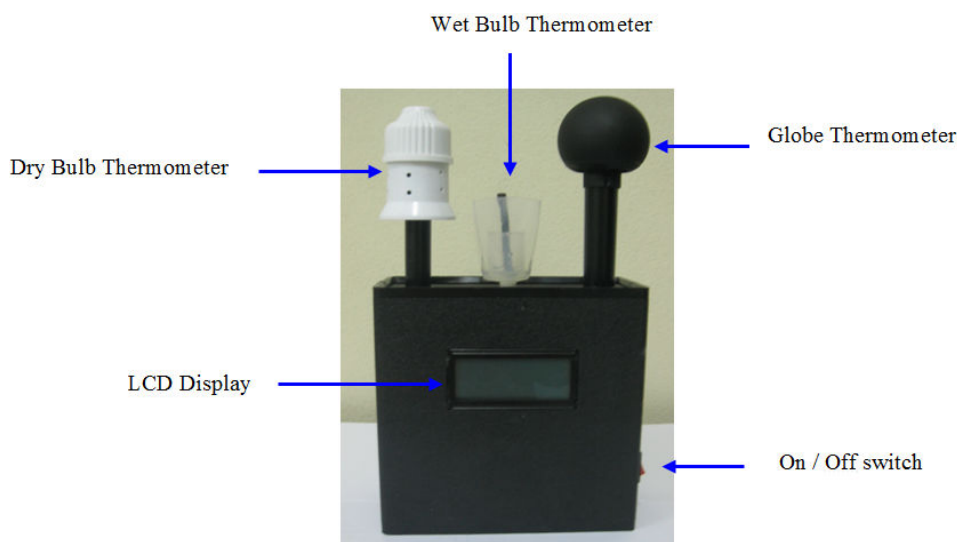

Fig. 2 Heat stress monitor device

III. RESULTS AND DISCUSSION

This section can be divided into three sub-sections as follows.

*A. Results without Calibration*

After measuring the levels of the temperature and humidity

of the monitor created by using SHT15 and DS18B20 temperature/humidity sensors and a standard WBGT heat pressure monitor, it was found that before the calibration the globe temperature, dry bulb temperature, wet bulb temperature and the humidity of the created monitor had different measurement values from those of the standard WBGT.

Therefore, it indicated that the heat pressure monitor we created had high measurement errors, as shown in Fig 3 – 6.

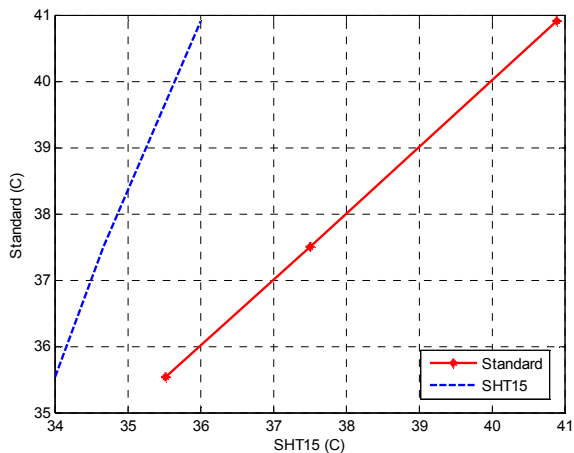

Fig. 3 Globe temperature measurement

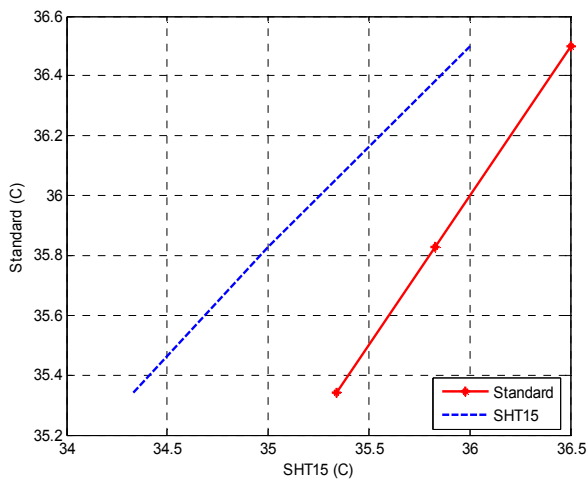

Fig. 4 Dry bulb temperature measurement

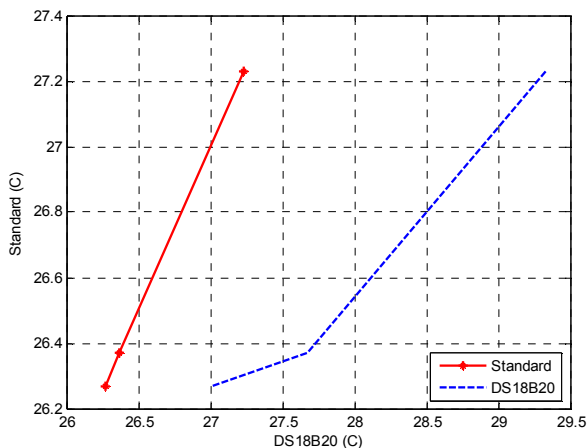

Fig. 5 Wet temperature measurement

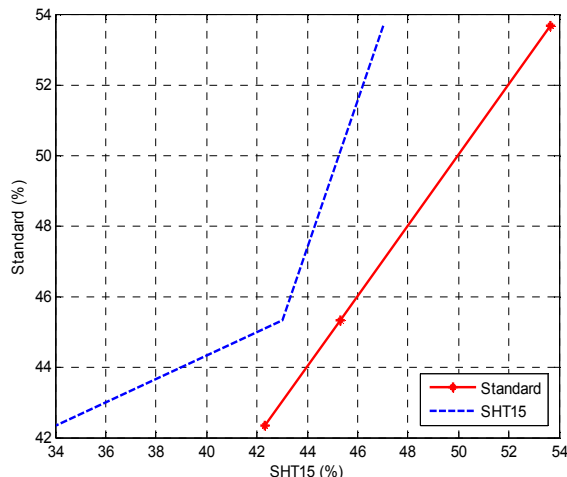

Fig. 6 Relative humidity measurement

This section can be divided into three sub-sections as follows.

### B. Results after Calibration

From all measured results from three types of temperature and the humidity, these measured values are required to be adjusted to follow the standard measurement values. To adjust these values, calibration curves must be formulated in order to minimize the measurement error. For simplification, we assume that the relation between the standard values measured by using the standard equipment and the proposed values obtained by the proposed device is linear and can be described by a simple linear equation as  $y = ax + b$ . It notes that  $x$  is the value from the proposed heat stress device and  $y$  is the value measured by using the standard WBGT monitor. As a result, the calibration graphs of which can be shown in Fig 7 – 10.

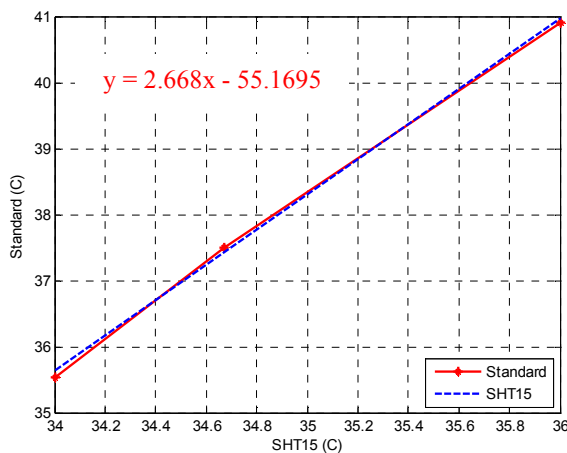

Fig. 7 Globe temperature measurement calibration

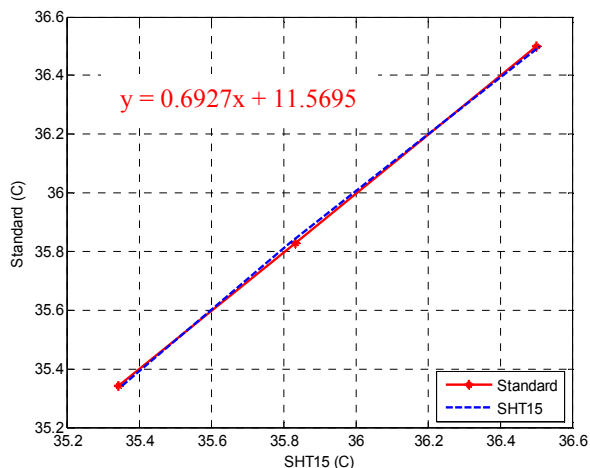

Fig. 8 Dry bulb temperature measurement calibration

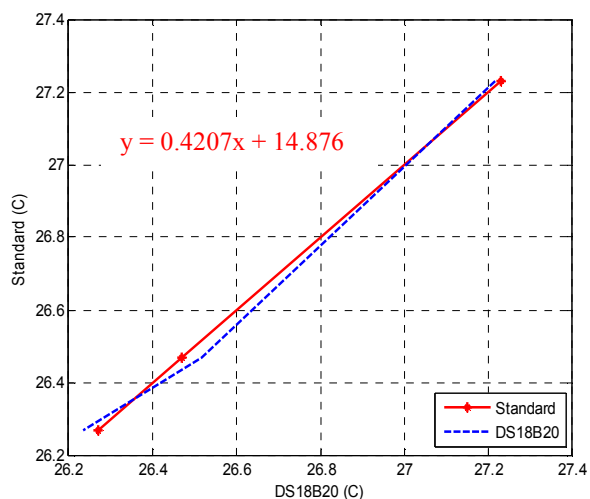

Fig. 9 Wet temperature measurement calibration

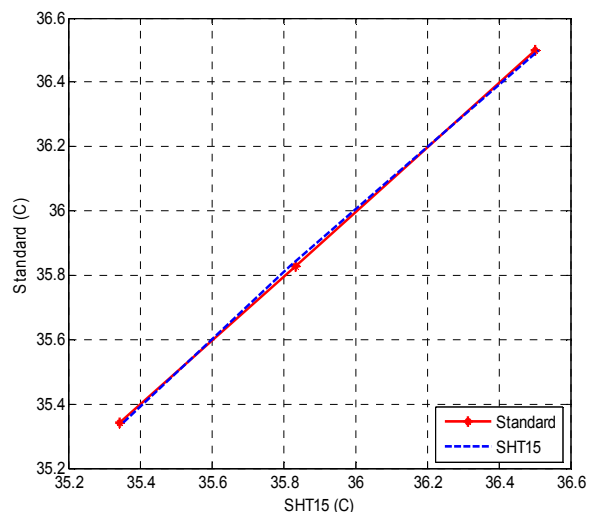

Fig. 10 Relative humidity measurement calibration

### C. Measurement Summary

The accuracy of the developed heat stress monitor was adjusted so that the monitor would be able to read out the same heat value as a standard WBGT. Therefore, the heat was measured at normal temperature and pressure in a laboratory. The study found that the mean percentage error in measurement of globe temperature was at 2.33 (SD = 2.71), that the mean percentage error in measurement of dry bulb temperature was at 0.94 (SD = 1.02), that the mean percentage error in measurement of wet bulb temperature was at 0.79 (SD = 0.48), and that the mean percentage error in measurement of relative humidity was at 4.46(SD = 1.60), as shown in Table I.

TABLE I  
 PERCENT ERROR AND STANDARD DEVIATION OF THE PROPOSED DEVICE

Temperature	Percentage Error (%)			
	Min	Max	Mean	SD
Globe Temp.	0	7.63	2.33	2.71
DB Temp.	0	2.29	0.94	1.02
WB Temp.	0.36	1.52	0.79	0.48
Rel. Humidity	2.38	6.67	4.46	1.60

### D. Result Discussion

It was found that the WBGT heat stress monitor we created had low measurement errors (no greater than 5%) while the highest measurement error of relative humidity sensor was 4.46%. As a result, this developed WBGT heat stress monitor is suitable to use in a working place since Ministry of Labor's Regulation on Setting the Administrative and Management Standard for Safety and Health in Working Environment concerning Heat, Light and Noise B.E. 2549 [7] does not apply the relative humidity factor to specify WBGT temperature. Furthermore, the total cost of this device is relatively lower than a commercial heat stress monitor being sold in the market.

## IV. CONCLUSION

We created a WBGT heat stress monitor by using low-cost SHT15 and DS18B20 temperature/humidity sensors with an ATmega328 microcontroller. The results of the study showed that the mean percentage error and the standard deviation of the globe temperature, dry bulb temperature, wet bulb temperature and relative humidity measurement were (2.33, 2.71), (0.94,1.02), (0.79,0.48) and (4.46,1.60), respectively. In addition, this proposed device is a low-cost heat stress monitor with satisfactory accuracy in comparison with a commercial heat stress monitors being sold in the market.

#### REFERENCES

- [1] D.S. Moran et al. An environmental stress index (ESI) as a substitute for the wet bulb globe temperature (WBGT). *Thermal Biology* 26 (2001) 427–431
- [2] Jose Perez-Alonso et al. Approach to the evaluation of the thermal work environment in the greenhouse-construction industry of SE Spain. *Building and Environment* 46 (2011) 1725e1734
- [3] American Conference of Governmental Industrial Hygienists. TLV & BEI based on the documentation for the threshold limit values for chemical substance and physical agents & biological exposure indices. 2008
- [4] Chalermchai Chaikittiporn. Safety and environment for industrial. Department of Environmental Quality Promotion, Ministry of Natural Resources and Environment
- [5] Pornpimol Kongtip. Industrial hygiene, Department of occupational health and safety, Faculty of public health, Mahidol University.
- [6] Wantanee Phanprasit, Mahidol University. The guideline for heat, light and sound monitoring B.E. 2549. 2006
- [7] Thailand Regulations, set standards for occupational health, safety and environment to work on heat, light and sound B.E. 2549. 2006
- [8] Aekkachai Makarn. Learn to use the AVR family of microcontrollers with Arduino, ETT Company Limited
- [9] Occupational safety and health bureau, Department of labour protection and welfare, Sampling and Evaluation of Physical Environments Manual, 2002
- [10] G. Buonanno, A. Frattolillo, L. Vanoli. Direct and indirect measurement of WBGT index in transversal flow, *Measurement* 29 (2001) 127–135
- [11] Grahame M. Budd. Wet-bulb globe temperature (WBGT) - its history and its limitations, *Science and Medicine in Sport* (2008) 11, 20 - 32

**Kiattisak Batsungnoen** is the chair of the School of Occupational Health and Safety, Institute of Medicine, Suranaree University of Technology, Nakhon Ratchasima, Thailand. His fields of research interest include occupational health and safety, industrial hygiene and safety, occupational and environmental medicine, occupational health and safety management and ergonomics. He received B.Sc. in occupational health and safety from Suranaree University of Technology, Thailand (2004), Ms.C in Industrial Hygiene and safety from Mahidol University, Thailand (2007).

**Thanatchai Kulworawanichpong** is an associate professor of the School of Electrical Engineering, Institute of Engineering, Suranaree University of Technology, Nakhon Ratchasima, Thailand. His fields of research interest include a broad range of power systems, power electronics and electrical drives, lighting and illumination, optimization and artificial intelligences. He received B.Eng. with first-class honour in Electrical Engineering from Suranaree University of Technology, Thailand (1997), M.Eng. in Electrical Engineering from Chulalongkorn University, Thailand (1999), and Ph.D. in Electronic and Electrical Engineering from the University of Birmingham, United Kingdom (2003).