

A 2D-3D Hybrid Vision System for Robotic Manipulation of Randomly Oriented Objects

Moulay A. Akhloufi

Abstract—This paper presents a new vision technique for robotic manipulation of randomly oriented objects in industrial applications. The proposed approach uses 2D and 3D vision for efficiently extracting the 3D pose of an object in the presence of multiple randomly positioned objects. 2D vision permits to quickly select the objects of interest for 3D processing with a new modified ICP algorithm (FaR-ICP), thus reducing significantly the processing time. The extracted 3D pose is then sent to the robot manipulator for picking. The tests show that the proposed system achieves high performances.

Keywords—3D vision, Hand-Eye calibration, robot visual servoing, random bin picking.

I. INTRODUCTION

ROBOTIC bin picking is a process that is widely used in industrial applications. In general the objects of interest are put in a controlled environment and the manipulation becomes an easy task. 2D vision can be used efficiently to detect the object and send its position to the robot manipulator for picking. This visual servoing of robot arms to accomplish simple tasks has been previously studied [1]-[4]. However when the objects are randomly positioned, the task becomes more complex. The complexity is further increased when we have a randomly oriented object, making its manipulation a difficult task for a robot hand. In this later case 3D vision [5] is necessary in order to extract the 3D pose of the object and orient the robot hand for its manipulation. Many available solutions use a 3D camera (in general a laser triangulation system) put on a robot hand in order to scan the randomly oriented objects. The 3D pose of an object is computed and the robot picks one object at a time. After picking the object the process of scanning starts again. This is done for each object to manipulate, making the random bin picking a time-consuming task. In order, to make this process more efficient, we propose the use of a hybrid 2D-3D system for manipulating randomly oriented objects. The proposed system permits an intelligent monitoring of the robotic manipulation process, thus avoiding repetitive scanning of the objects in the bin.

M. A. Akhloufi is with Centre de Robotique et Vision Industrielles, Levis, QC, G6V 6Z9, Canada and with Vision Systems Laboratory, Laval University, Quebec, QC G1V0A6 (phone: 418-833-1965 x3275; fax: 418-833-8726; e-mail: moulay.akhloufi@crvi.ca, akhloufi@gel.ulaval.ca).

II. PROPOSED APPROACH

3D random bin picking can be a time consuming task due to repetitive scanning of the bin with a 3D laser triangulation camera each time an object must be picked. In order to accelerate this process, a new approach based on a hybrid 2D-3D system is proposed. It operates as follows:

- 1) A 3D image of the objects is captured using a 3D camera (in general a 3D laser triangulation camera. However the proposed system can be adapted to any type of 3D acquisition system).
- 2) A 2D image of the same objects is captured simultaneously with the 3D image. The 2D vision system is fixed and positioned over the bin of randomly oriented objects.
- 3) A 2D orientation and scale invariant pattern matching is performed in order to select the objects of interest. Various types of objects present in the same bin can be handled with this approach.
- 4) Based on a scoring scheme the detected objects are sorted and N candidates are selected for further processing.
- 5) For each selected candidate, the following procedure is performed:
 - i. The position of the 2D matching is used to create a mask for ROI extraction.
 - ii. The visible object volume is computed in order to evaluate the possibility of picking this object.
 - iii. The pose of the object is computed using a 3D pattern matching algorithm and a matching score is computed.
- 6) If the previous 3D processing detects that the object can be picked then:
 - i. Its position and orientation are sent to the robot manipulator.
 - ii. Otherwise, go to step 5, to process the next object.
- 7) Since picking and object by a robot hand can change other object positions in the bin, a new 2D image is captured and compared to the previous captured image (Only the position of the previous selected objects in step 4 are analyzed).
- 8) The status of the bin is then verified. The following procedure is performed :
 - i. If the majority of the selected objects are at the same configuration (as in step 2), then go to step 5.
 - ii. Otherwise, go to step 1 to scan the bin with the 3D camera system.

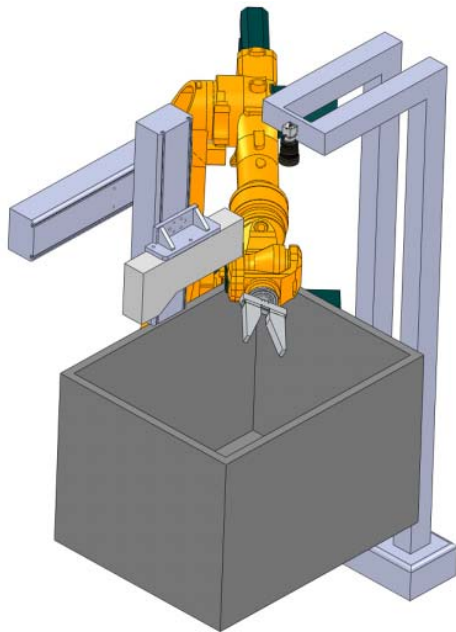

Fig. 1 The Random bin picking robotic system with 2D and 3D cameras

III. 2D VISION SYSTEM

2D pattern matching is an area of computer vision that has been largely studied. Many techniques exist for pattern matching [6]-[11]: correlation, moments, Fourier descriptors, generalized Hough transform, SIFT, SURF, etc.

Many of the available techniques are limited to a fixed scale and orientation. These techniques are widely used in industrial vision application where we can control the working environment.

Since we are interested in randomly oriented objects, we need to use pattern matching techniques that are invariant to scale and orientation, like the generalized Hough transform (GHT).

A. Generalized Hough Transform (GHT)

The Hough Transform is a commonly used algorithm for detecting shapes in an image. This technique is based on the original Hough Transform algorithm used for detecting an object having a simple analytic equation describing its boundary. Hough transform is largely used for detecting lines, circles or ellipses.

An extension of the standard Hough was proposed in [11]. GHT supports object boundaries of arbitrary non-analytic shape. Instead of using a parametric equation, GHT uses a look-up table to define the relationship between the boundary positions and orientations and the Hough space parameters. In order to detect an object a model of this object is learned and a look-up table values computed offline.

For example, suppose that we know the shape and orientation of the desired feature. (See figure 2) We can specify an arbitrary reference point (x_{ref}, y_{ref}) within the feature, with respect to which the shape (i.e. the distance r and angle β of normal lines drawn from the boundary to this

reference point) of the feature is defined. Our look-up table (i.e. *R-table*) will consist of these distance and direction pairs, indexed by the orientation Ω of the boundary.

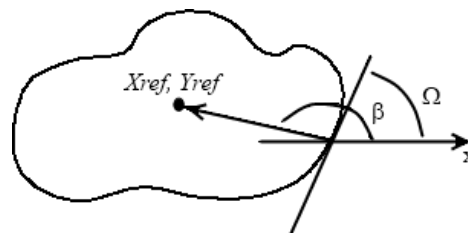

Fig. 2 *R-table* components

The Hough transform space is now defined in terms of the possible positions of the shape in the image, i.e. the possible ranges of (x_{ref}, y_{ref}) . In other words, the transformation is defined by:

$$\begin{aligned} x_{ref} &= x + r \cos(\beta) \\ y_{ref} &= y + r \sin(\beta) \end{aligned} \quad (1)$$

(The r and β values are derived from the *R-table* for particular known orientations Ω) If the orientation of the desired feature is unknown, this procedure is complicated by the fact that we must extend the accumulator by incorporating an extra parameter to account for changes in orientation.

B. Object Matching Selection

GHT is an interesting technique for invariant matching. However this technique can be time consuming if we need to support various scales and orientations. Also, when we learn an object shape, we need to learn different views of this object since it is randomly positioned.

In order to handle these situations we use the following strategies:

- 1) Only a fixed set of views of the same object are learned. If a view is not used in the learning process, the matching score will be lower and the object will not be picked. It will be processed and picked later.
- 2) If all the matching scores are very low, a robot is used to shake the bin in order to unravel the objects. This strategy can only be used in cases where the objects can not be damaged with this manipulation.
- 3) To speed-up the processing, a pyramidal matching-search strategy is performed. Lower scale images are used for the matching and best candidates are verified in upper scales.
- 4) To reduce the search in the Hough space for orientation and scales we use the following:
 - i. The orientation is searched using a coarse to fine angle search.
 - ii. The orientation search is restricted based on the learned views of the object.
 - iii. The data from the 3D image is used to restrict the scale search.

Once the matching is performed a score is computed. This score represent the best fit between the learned object and its match in the image. The index of the best matching model corresponds to one of the object views.

With this approach, different objects can be learned when a bin contains various types of objects randomly oriented.

IV. 3D VISION SYSTEM

In this work, we use a 3D pattern matching technique for object recognition and pose estimation. An algorithm based on ICP (Iterative Closest Point) is used. This algorithm is called FaR-ICP (Fast and Robust ICP) and permits the robust and fast convergence of ICP by exploiting a 2D data for initialization and a robust algorithm for outlier detection and elimination.

A. Iterative Closest Point

Iterative Closest Point (ICP) is an algorithm employed to minimize the difference between two clouds of points. ICP is often used to reconstruct 2D or 3D surfaces from different scans, to localize robots and achieve optimal path planning, to co-register 3D models, etc. The algorithm is conceptually simple and is commonly used in real-time. It iteratively revises the transformation (translation, rotation) needed to minimize the distance between the points of two raw scans.

The ICP Algorithm was developed by Besl and McKay [12] and is usually to register two given point sets in a common coordinate system [13]. The algorithm calculates iteratively the registration. In each iteration step, the algorithm selects the closest points as correspondences and calculates the transformation, i.e., rotation and translation (R, t), for minimizing the following equation:

$$E(R, t) = \sum_{i=1}^{N_m} \sum_{j=1}^{N_d} w_{i,j} \|m_i - (Rd_j + t)\|^2 \quad (2)$$

where N_m and N_d are the number of points in the model set M and data set D , respectively, and w_{ij} are the weights for a point match. The weights are assigned as follows:

$$\begin{cases} w_{ij} = 1, & \text{if } m_i \text{ is the closest point to } d_j \\ w_{ij} = 0, & \text{otherwise} \end{cases} \quad (3)$$

Equation (2) can be reduced to:

$$E(R, t) \approx \frac{1}{N} \sum_{i=1}^N w_{i,j} \|m_i - (Rd_j + t)\|^2 \quad (4)$$

with $N = \sum_{i=1}^{N_m} \sum_{j=1}^{N_d} w_{i,j}$, since the correspondence matrix can be represented by a vector V containing the point pairs, i.e., $V = [(d_1, m_{f(d_1)}), (d_2, m_{f(d_2)}), \dots, (d_{N_d}, m_{f(d_{N_d})})]$, with

$f(x)$ the search function returning the closest point. The assumption is that in the last iteration step the point correspondences, thus the vector of point pairs, are correct.

In each ICP iteration, the transformation can be calculated by any of these four methods:

- 1) A SVD based method of Arun et al. [14].
- 2) A quaternion method of Horn [15].
- 3) An algorithm using orthonormal matrices of Horn et al. [16].
- 4) A calculation based on dual quaternions of Walker et al. [17].

These algorithms show similar performance and stability concerning noisy data [18].

Besl and McKay show that the iteration terminates in a minimum [12]. Normally, implementations of ICP would use a maximal distance for closest points to handle partially overlapping point sets. In this case the proof in [12] does no longer hold, since the number of points as well as the value of $E(R, t)$ might increase after applying a transformation.

The basic algorithm has been previously extended in a number of ways:

- 1) Correspondence between a point and a tangent plane to overcome the lack of an exact correspondence between the two sets [19].
- 2) Robustifying the algorithm to the influence of outliers and features lacking correspondences [20],[21].
- 3) Using a weighted least-square error metric [22].
- 4) Matching between features using a metric trading off distance and feature similarity (based local shape invariances) [23].

All of these approaches assume a rigid Euclidean transformation between the corresponding features.

B. Initialization

Initialization of ICP is critical for achieving fast convergence. In our approach we initialize ICP with the results obtained in the 2D matching step. The index of the best matching model corresponds to one of the object views. This information is used as an initial guess for the 3D matching process. The 2D matching gives the 2D position of the object (x, y) and the 2D angles (θ_x, θ_y) along the x-y plan. The initial z coordinates is computed by averaging the 3D data from the scanned point cloud corresponding to the detected object. The initial guess of angle θ_z along the z axis is computed as follows:

- 1) When some object features are detected in the 2D image, they are extracted in the 3D image and used to estimate the angle.
- 2) When no feature is present, the initial guess is kept equal to 0 degrees.

The initial guess permitted to accelerate the processing and increase the robustness of ICP even when some data are missing from the object.

C. Outlier Processing

Other important aspect for ICP robustness is the presence of outliers. 3D scanning is prone to invalid data points that can have dramatic impacts in the obtained results. For outlier detection and elimination we used RANSAC algorithm [24].

RANSAC or "RANDOM SAMPLE CONSENSUS". It is an iterative method to estimate parameters of a mathematical model from a set of observed data which contains outliers. It is a non-deterministic algorithm in the sense that it produces a reasonable result only with a certain probability, with this probability increasing as more iteration are allowed.

A basic assumption is that the data consists of "inliers", i.e., data whose distribution can be explained by some set of model parameters, and "outliers" which are data that do not fit the model. In addition to this, the data can be subject to noise. The outliers can come, e.g., from extreme values of the noise or from erroneous measurements or incorrect hypotheses about the interpretation of data. RANSAC also assumes that, given a (usually small) set of inliers, there exists a procedure which can estimate the parameters of a model that optimally explains or fits this data.

The input to the RANSAC algorithm is a set of observed data values, a parameterized model which can explain or be fitted to the observations, and some confidence parameters.

RANSAC achieves its goal by iteratively selecting a random subset of the original data. These data are hypothetical inliers and this hypothesis is then tested as follows:

- 1) A model is fitted to the hypothetical inliers, i.e. all free parameters of the model are reconstructed from the data set.
- 2) All other data are then tested against the fitted model and, if a point fits well to the estimated model, also considered as a hypothetical inlier.
- 3) The estimated model is reasonably good if sufficiently many points have been classified as hypothetical inliers.
- 4) The model is estimated again from all hypothetical inliers, because it has only been estimated from the initial set of hypothetical inliers.
- 5) Finally, the model is evaluated by estimating the error of the inliers relative to the model.

This procedure is repeated a fixed number of times, each time producing either a model which is rejected because too few points are classified as inliers or a refined model together with a corresponding error measure. In the latter case, we keep the refined model if its error is lower than the last saved model. Figure 3 gives the details about the RANSAC algorithm.

```
input:
data - a set of observations
model - a model that can be fitted to data
n - the minimum number of data required to fit the model
k - the number of iterations performed by the algorithm
t - a threshold value for determining when a datum fits a model
d - the number of close data values required to assert that a model
fits well to data
output:
best_model - model parameters which best fit the data (or nil if no
good model is found)
best_consensus_set - data point from which this model has been
estimated
best_error - the error of this model relative to the data

iterations := 0
best_model := nil
best_consensus_set := nil
best_error := infinity
while iterations < k
  maybe_inliers := n randomly selected values from data
  maybe_model := model parameters fitted to maybe_inliers
  consensus_set := maybe_inliers

  for every point in data not in maybe_inliers
    if point fits maybe_model with an error smaller than t
      add point to consensus_set

  if the number of elements in consensus_set is > d
    (this implies that we may have found a good model,
    now test how good it is)
    better_model := model parameters fitted to all points in
consensus_set
    this_error := a measure of how well better_model fits these
points
    if this_error < best_error
      (we have found a model which is better than any of the
previous ones,
      keep it until a better one is found)
      best_model := better_model
      best_consensus_set := consensus_set
      best_error := this_error

  increment iterations
return best_model, best_consensus_set, best_error
```

Fig. 3 RANSAC Algorithm

V. 2D-3D IMAGE REGISTRATION

In order to process the 2D and 3D images as proposed in this work, we need to register the 2D and 3D images. Different techniques exist for 2D-3D [25],[26] based on the extraction and matching of detected features. In this work we use a measuring square like tool with known 3D dimensions and visible in 2D and 3D image in order to register the obtained images. Since the 3D image is acquired at high resolution using a Laser triangulation 3D camera, we use the detected tool to affine transform the 3D image to the 2D image scale. We obtain two co-registered images with corresponding pixel positions.



Fig. 4 A measuring square like tool with known 3D dimensions for 2D and 3D image registration

VI. INTELLIGENT DATA PROCESSING AND ROBOT CONTROL

The algorithm presented in section 2 is implemented as an intelligent data processing manager. This system process the

information captured by the 2D and 3D cameras, selects the best matches in 2D and 3D space and sorts the objects to be manipulated by the robot. The system also monitors the image for change detection and dispatches the different processing modules. It also computes the position and orientation of the object in the robot space and sends necessary controls for object manipulation.

In order to manipulate the objects based on the visual information captured by the hybrid 2D-3D vision system, a hand-eye calibration procedure is performed. This calibration permits the projection of the detected image data to the robot space. A simple hand-eye calibration is presented in [27].

The intelligent data processing system is illustrated by figure 5.

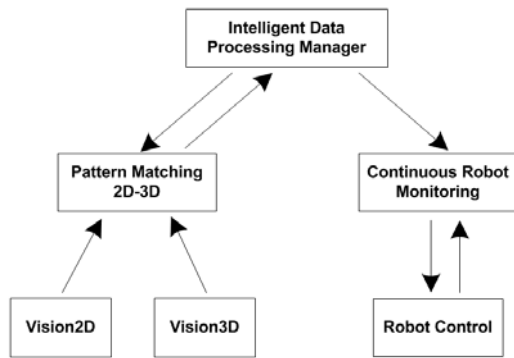

Fig. 5 Intelligent data processing system

VII. RESULTS

Experimental tests were conducted using a three-axis XYZ Cartesian robot. A 5MP 2D camera (2500x1900pix) and a 3D laser triangulation camera with a depth resolution of 0.2mm were used. The 2D camera was fixed to capture the working field of view and a 3D camera was fixed on the moving end of the robot in order to scan the objects positioned in the working area (Figure 6).

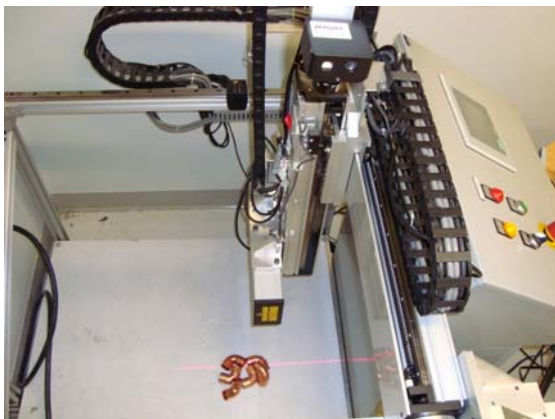

Fig. 6 XYZ 3-axis robot system with 2D and 3D cameras

The high resolution 2D camera captures the working area (Figure 7) and then the same area is scanned using the high speed 3D camera (3000 profiles/s) (Figure 8 a.). The 3D

image is used to extract and reconstruct 3D points cloud of the captured scene (Figure 8 b.).



Fig. 7 2D image captured with a 5MP camera



(a)

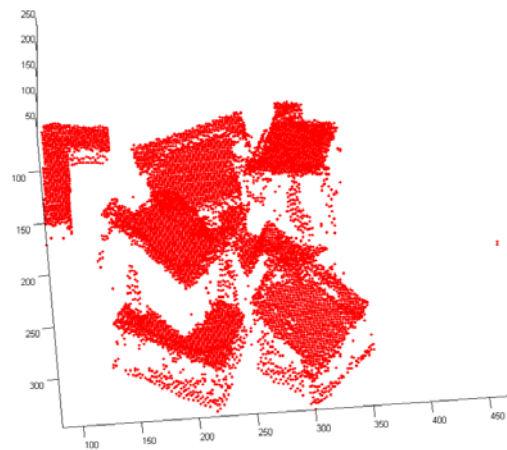

(b)

Fig. 8 3D image captured with a 3D laser triangulation camera (a); Reconstructed 3D points cloud of the objects (b)

The measuring square like tool (upper left area in the 2D and 3D images in Figure 7 and 8) is used to register the 2D and 3D images.

A 2D pattern matching permits the extraction of the N best candidates based on the matching scores (Figure 9).

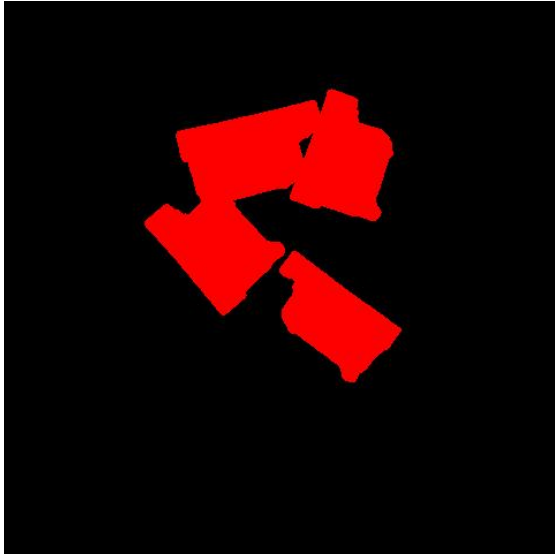

Fig. 9 Selected objects

The best candidates are then selected and processed as proposed in the algorithm presented in section 2. The highest score best match is selected and processed first (Figure 10). An area of interest around this best match is selected as illustrated in figure 11 a. and b. The 3D point cloud of this object is then extracted for a 3D pattern matching using FaR-ICP (Figure 11 c.).

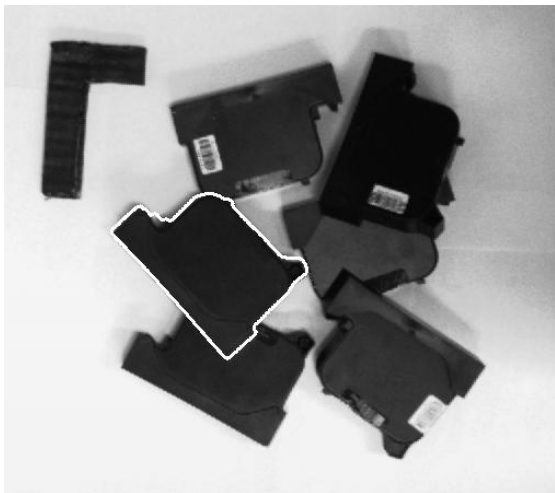

Fig. 10 First best object selected for processing

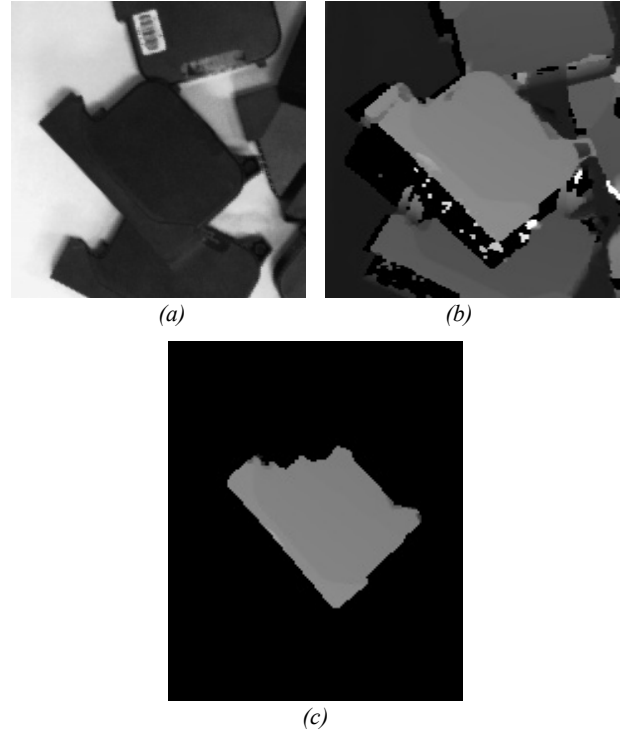
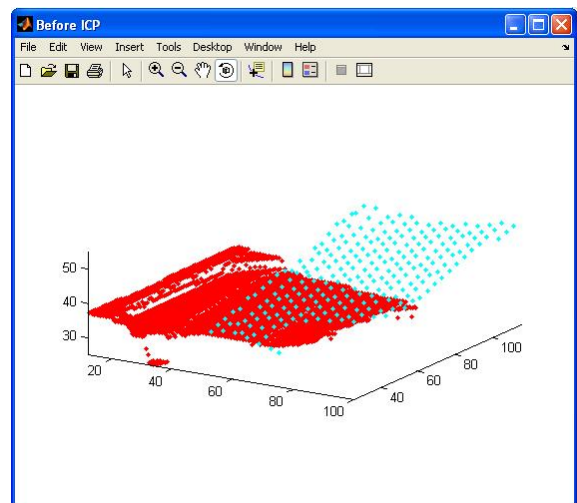

Fig. 11 First best object: selected area of interest in the 2D image (a); and its corresponding 3D image (b); 3D points could extracted for ICP (c)

The 3D data is matched with a 3D reference model of the object using the proposed ICP strategy presented in section 4. The proposed initialization and outlier detection strategies permit a robust and fast convergence of the FaR-ICP algorithm (Figure 12).

The 3D matching permits the computation of the pose data of the object, its position and orientation in space $(x, y, z, \theta_x, \theta_y, \theta_z)$. This information is projected to the robot reference frame for manipulation using the calibration data extracted during the hand-eye calibration procedure.



(a)

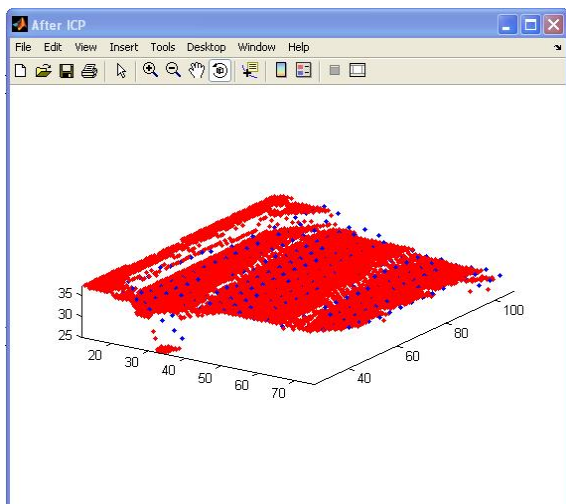

(b)

Fig. 12 FaR-ICP: starting point (a); after ICP convergence (b). In red the reference model and in bleu the extracted object points cloud

The tests conducted with the three-axis Cartesian robot show that the positions were correctly computed. Also, the computed were verified manually on multiple objects and the results correspond to the ground truth.

The steps presented in this section are repeated for different detected objects as presented in the algorithm of section 2.

VIII. CONCLUSION

In this work, we introduce a new algorithm for efficiently manipulating randomly positioned and oriented objects. The approach uses a hybrid 2D-3D vision system and an intelligent control system for selecting the best object to manipulate by a robot arm.

A new modified ICP algorithm for 3D matching was presented. FaR-ICP is a fast and robust iterative closest point algorithm for extracting the 3D pose of known object in the scene using its reference model.

The performance of the proposed algorithms was successfully tested using a three-axis Cartesian robot. Ongoing work is conducted in order to adapt the proposed system to a six-axis industrial robot manipulator. Since the proposed system is generic, it will be adapted and tested with major industrial robot arms (Fanuc [28], KUKA [29], ABB [30], etc.).

Future work includes testing the system with different 3D acquisition technologies and increasing the speed of different processing steps using GPGPU technology.

ACKNOWLEDGMENT

This work has been supported by a research grants from Quebec Ministry of Education - Canada: PART2010A058. Special thanks to D. Bouchard and M. Laframboise who collaborated to the experimental tests.

REFERENCES

- [1] Wilson, W.J., Hulls, C.C.W., Bell, G.S.: Relative End-Effector Control Using Cartesian Position Based Visual Servoing. IEEE Trans. Robotics and Automation. Vol. 12, No. 5, pp. 684—696 (1996)
- [2] Grosso, E., Metta, G., Oddera, A., Sandini, G.: Robust Visual Servoing in 3-D Reaching Tasks. IEEE Trans. Robotics and Automation RA. Vol. 12, No. 5, pp. 732—742 (1996)
- [3] Wijesoma, S.W., Wolfe, D.F.H., Richards, R.J.: Eye-to-Hand Coordination for Vision-Guided Robot Control Applications. International Journal of Robotics Research. Vol. 12, pp. 65--78 (1993)
- [4] Sanchez, A.J., Martinez, J.M.: Robot-arm Pick and Place Behavior Programming System Using Visual Perception. In: 15th International Conference on Pattern Recognition, Vol. IV, pp. 507—510, Barcelona, Spain (2000)
- [5] Hartley, R., Zisserman, A.: Multiple View Geometry in Computer Vision. Cambridge University Press (2000)
- [6] Lowe, David G. (1999). "Object recognition from local scale-invariant features". Proceedings of the International Conference on Computer Vision. 2. pp. 1150–1157.
- [7] Herbert Bay, Andreas Ess, Tinne Tuytelaars, Luc Van Gool "SURF: Speeded Up Robust Features", Computer Vision and Image Understanding (CVIU), Vol. 110, No. 3, pp. 346--359, 2008
- [8] Krystian Mikolajczyk and Cordelia Schmid "A performance evaluation of local descriptors", IEEE Transactions on Pattern Analysis and Machine Intelligence, 10, 27, pp 1615--1630, 2005.
- [9] Sarfraz, S., Hellwich, O.: "Head Pose Estimation in Face Recognition across Pose Scenarios", Proceedings of VISAPP 2008, Int. conference on Computer Vision Theory and Applications, Madeira, Portugal, pp. 235-242, January 2008
- [10] Tarsha-Kurdi, F., Landes, T., Grussenmeyer, P., 2007a. Hough-transform and extended RANSAC algorithms for automatic detection of 3d building roof planes from Lidar data. ISPRS Proceedings. Workshop Laser scanning, Espoo, Finland, September 12–14, 2007
- [11] D.H. Ballard, "Generalizing the Hough Transform to Detect Arbitrary Shapes", Pattern Recognition, Vol.13, No.2, p.111-122, 1981
- [12] P. Besl and N. McKay. A method for Registration of 3-D Shapes. IEEE Transactions on Pattern Analysis and Machine Intelligence (PAMI), 14(2):239 - 256, February 1992.
- [13] Andreas Nüchter, Kai Lingemann, and Joachim Hertzberg. Cached k-d tree search for ICP algorithms. In Proceedings of the 6th IEEE International Conference on Recent Advances in 3D Digital Imaging and Modeling (3DIM '07), IEEE Computer Society Press, pp. 419-426, Montreal, Canada, August 2007,
- [14] K. S. Arun, T. S. Huang, and S. D. Blostein. Least square fitting of two 3-d point sets. IEEE Transactions on Pattern Analysis and Machine Intelligence, 9(5):698 - 700, 1987.
- [15] B. K. P. Horn. Closed-form solution of absolute orientation using unit quaternions. Journal of the Optical Society of America A, 4(4):629 - 642, April 1987.
- [16] B. K. P. Horn, H. M. Hilden, and Sh. Negahdaripour. Closed-form solution of absolute orientation using orthonormal matrices. Journal of the Optical Society of America A, 5(7):1127 - 1135, July 1988.
- [17] M. W. Walker, L. Shao, and R. A. Volz. Estimating 3-d location parameters using dual number quaternions. CVGIP: Image Understanding, 54:358 - 367, November 1991.
- [18] A. Lorusso, D. Eggert, and R. Fisher. A Comparison of Four Algorithms for Estimating 3-D Rigid Transformations. In Proceedings of the 4th British Machine Vision Conference (BMVC '95), pages 237 - 246, Birmingham, England, September 1995.
- [19] Y. Chen, G. G. Medioni. Object modelling by registration of multiple range images. Image and Vision Comp. 10(3), pp 145-155, 1992.
- [20] Z. Y. Zhang. Iterative point matching for registration of free-form curves and surfaces. Int. J. of Computer Vision, 13(2), pp 119-15, Oct. 1994.
- [21] T. Masuda, N. Yokoya. A robust method for registration and segmentation of multiple range images. Comp. Vision and Image Under. 61(3), pp 295-307, May 1995.
- [22] C. Dorai, J. Weng, A. K. Jain. Optimal registration of object views using range data. IEEE Trans. Pat. Anal. and Mach. Intel. 19(10), pp 1131-1138, Oct 1997.

- [23] G. C. Sharp, S. W. Lee, D. K. Wehe. Invariant features and the registration of rigid bodies. Proc. IEEE Int. Conf. on Robotics and Autom., pp 932-937, 1999.
- [24] Martin A. Fischler and Robert C. Bolles (June 1981). "Random Sample Consensus: A Paradigm for Model Fitting with Applications to Image Analysis and Automated Cartography". Comm. of the ACM 24: 381-395
- [25] Daniel B. Russakoff, Torsten Rohlfing, Calvin R. Maurer, Jr., "Fast Intensity-based 2D-3D Image Registration of Clinical Data Using Light Fields," iccv, vol. 1, pp.416, Ninth IEEE International Conference on Computer Vision (ICCV'03) - Volume 1, 2003
- [26] A. Kubias, F. Deinzer, T. Feldmann, D. Paulus, B. Schreiber, Th Brunner. 2D/3D image registration on the GPU. Pattern Recognition and Image Analysis, Vol. 18, No. 3. (2008), pp. 381-389
- [27] M.A. Akhloufi,. Real-time 3D visual servoing of an industrial cutting robot manipulator. Proc. International Conference on Control, Automation, Robotics and Vision (ICCARV 2009), WASET Vol. 60, pp. 432-436, ISSN: 2070-3724, Bangkok, Thailand, December 2009.
- [28] Fanuc Robotics, <http://www.fanucrobotics.com/>
- [29] KUKA Robotics, <http://www.kuka-robotics.com/>
- [30] ABB Robotics, <http://abb.com>

Moulay Akhloufi received the B. Eng (1996), M.Sc. in Electrical Engineering from Ecole Polytechnique of Montreal, Canada in 1999, a MBA from Laval University, Canada in 2006 and a Ph.D in Electrical Engineering from Laval University, Quebec, Canada in 2012.

He was an Associate Researcher with Perception and Robotics Laboratory of Ecole Polytechnique in 1999. Then he joined Matrox Imaging as a Computer Vision Specialist from 2000 till 2006. He is since 2006 with the Robotics and Vision Center, Levis, Quebec as a Machine Vision Project Manager and since 2008 as a Research and Development Manager.

His research interests are in infrared imaging, face recognition, robot vision and intelligent surveillance systems. He is involved with SPIE and IEEE organizations.