

Direct Sequence Spread Spectrum Technique with Residue Number System

M. I. Youssef, A. E. Emam, and M. Abd Elghany

Abstract—In this paper, a residue number arithmetic is used in direct sequence spread spectrum system, this system is evaluated and the bit error probability of this system is compared to that of non residue number system. The effect of channel bandwidth, PN sequences, multipath effect and modulation scheme are studied. A Matlab program is developed to measure the signal-to-noise ratio (SNR), and the bit error probability for the various schemes.

Keywords—Spread Spectrum, Direct sequence, Bit error probability and Residue number system.

I. INTRODUCTION

SPREAD Spectrum (SS) [1 - 5] has been defined as a means of transmission in which the signal occupies bandwidth much in excess of the minimum necessary to send the information. The band spread is accomplished by utilizing a “code” which is independent of the data and a synchronized reception with the code at the receiver is used for de-spreading and data recovery.

The SS Communications are widely used today for Military, Industrial, Avionics, Scientific, and Civil uses. The advantages of using SS include the following [3]:

- Low power spectral density.
 - As the signal is spread over a large frequency-band, the Power Spectral Density is getting very small, so other communication systems do not suffer from this kind of communication.
 - The ability to utilize the Satellite payload channels, which is achievable as the transmitted signal is spread in such a way that it become noise-like and thus would not interfere with the payload traffic.
- Interference limited operation.
- Privacy due to unknown random codes.
- Applying spread spectrum implies the reduction of multi-path effects.
- Random access possibilities. As users can start their transmission at any arbitrary time.
- Good anti-jam performance.

The cost paid is the need of a larger bandwidth which is already present due to the usage of the existing

communication channels and the need for good synchronization at the receiver to detect the reception of the signal.

Introducing residue number system (RNS) to the spread spectrum communication system in order to add more features to the communication system. The usage of RNS adds more security to the system through encrypting the data signal and converting arithmetic of large numbers to arithmetic on small numbers, thus improving the signal-to-noise ratio of the received signal and decreasing the bit error probability.

In section II of this paper a brief description of spread spectrum systems is provided. Section III the reason for using spread spectrum in distance measurements instead of RF distance measurements technique is provided, section IV provides system model description, section V provides some basic definitions for the main block sets in the RNS direct sequence spread spectrum system, section VI show the simulation results and finally section VII provide the conclusion and the future work in this field.

II. SPREAD SPECTRUM SYSTEM TECHNIQUE

Spread spectrum is introduced as a ranging method for orbit determination. Spread spectrum ranging is also called ‘Payload ranging’ as it is transmitted through the satellite payload channels. This is achievable as the transmitted signal is spread in such a way that it becomes noise like and thus would not interfere with the payload traffic and then reproduce the signal again at the receiver level. The detection of the time or phase delay between the transmitted and received signal, the operator could compute the distance.

Compared to classical Pseudo-range systems, the use of payload signals has various advantages for the satellite operator [6]. The payload based ranging signal is always present, that doesn’t need a dedicated activation, and have no impact on the satellite control activities, while classical Pseudo-range actually has to be activated by satellite commanding. For these reasons, tone ranging campaigns are limited in time, in contrary to payload methods, which provide continuous range data. Also, the accuracy of payload ranging is in general superior, mainly due to the large bandwidth and high signal-to-noise ratio. The latter two effects also make payload ranging an optimal solution for orbit determination.

The “code” [7] used for spreading the signal is a pseudo-random code that is mixed with the data to spread the signal in a statistically random matter. These codes are considered fast codes as they run many times the information bandwidth or

Manuscript received June 12, 2008.

M. I. Youssef is with the Al-Azhar University, Cairo, Egypt.

A. E. Emam is with the Al-Azhar University, Cairo, Egypt.

M. Abd Elghany is with the Al-Azhar University, Cairo, Egypt.

data rate. These special "Spreading" codes are called "Pseudo Random" or "Pseudo Noise" codes. They are called "Pseudo" because they are not real Gaussian noise.

The bandwidth expansion factor is called the Processing Gain (K) which can be defined as the ratio between the transmitted spread spectrum signal bandwidth (B) and the bandwidth of the original data sequence ($B_{message}$) where the Processing Gain is approximately the ratio of the spread bandwidth to the information rate R (bits/s) and it is much greater than unity.

$$K = \frac{B}{B_{message}} \approx \frac{B}{R} \quad (1)$$

Spread Spectrum transmitters use similar transmits power levels to narrow band transmitters. Because Spread Spectrum signals are so wide, they transmit at a much lower spectral power density, than narrowband transmitters. Spread and narrow band signals can occupy the same band, with little or no interference. Interference rejection capability arises from low mutual correlation between the desired signal and the interfering signal ensured by the codes. This capability is the main reason for all the interest in Spread Spectrum today.

There are many types of spread spectrum techniques [1 -2] as: Direct sequence (DS), frequency hopping, time hopping and hybrid system. Direct sequence (Fig 1) contrasts with the other spread spectrum process, in which a broad slice of the bandwidth spectrum is divided into many possible broadcast frequencies. In general, frequency-hopping devices use less power and are cheaper, but the performance of DS-CDMA systems is usually better and more reliable [8]. Thus, in this paper we will deal only with direct sequence method.

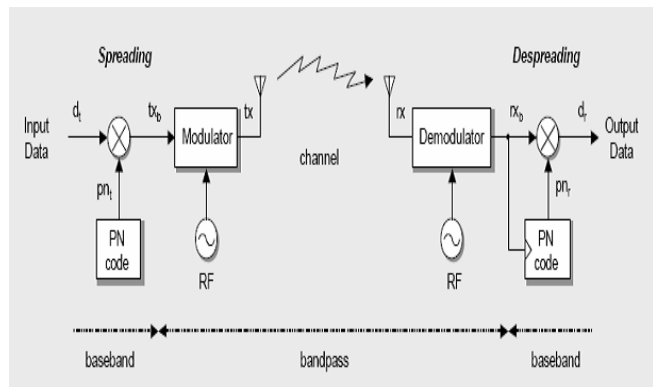

Fig. 1 DS-SS block diagram

In Direct Sequence-Spread Spectrum the baseband waveform is XOR by the PN sequence in order to spread the signal. After spreading, the signal is modulated and transmitted. The most widely modulation scheme is BPSK (Binary Phase Shift Keying). The equation that represents this DS-SS signal is shown in equation (2), and the block diagram is shown in Fig. 2.

$$S_{ss} = \sqrt{2 E_s/T_s} [m(t) \otimes p(t)] \cos(2 \pi f_c t + \theta) \quad (2)$$

Where:

$m(t)$ is the data sequence,

T_s is duration of data symbol.

$p(t)$ is the PN spreading sequence,

f_c is the carrier frequency,

θ is the carrier phase angle at $t=0$.

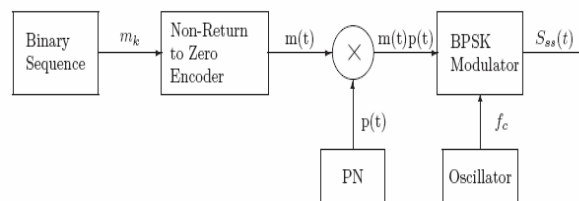

Fig. 2 DS-SS Transmitter block diagram

The demodulator, de-modulates the modulated (PSK) signal first, low Pass Filter the signal, and then de-spread the filtered signal, to obtain the original message. The process is described by the following equation (3),

$$m(t) = [S_{ss} * \cos(2 \pi f_c t + \theta)] \otimes p(t) \quad (3)$$

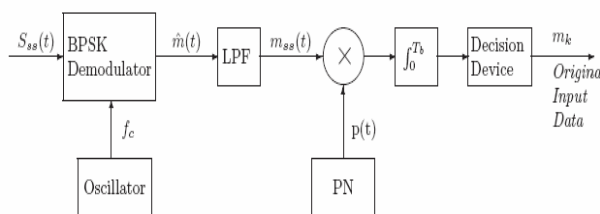

Fig. 3 DS-SS Receiver block diagram

It is clear that the spreading waveform is controlled by a Pseudo-Noise (PN) sequence, which is a binary random sequence. This PN is then multiplied with the original baseband signal, which has a lower frequency, which yields a spread waveform that has noise-like properties. In the receiver, the opposite happens, when the pass-band signal is first demodulated, and then de-spread using the same PN waveform. An important factor here is the synchronization between the two generated sequences.

III. COMMUNICATION PROBLEMS SOLVED BY SPREAD SPECTRUM

In this section, two main communication problems [4 - 5] that arise when using RF signals for distance ranging system will be discussed and it will be shown how the spread spectrum can solve them.

A. The Effect of Noise

Noise plays very important role for the limitation of using ranging measurements. Noise enters an RF ranging system from various sources of interference with range measurement.

Noise may mask the measurement signal or cause a spurious signal, as a consequence, the measurement signal may be undetected and even if the RF signal can be recognized with good reliability, the noise may have shifted the original measurement signal in time, changed its amplitude or have had some other detrimental effect on the measurement. Even with good system design, the noise remains as one of the main sources of unpredictable errors, limiting achievable measurement precision.

Consider a coherent binary phase-shift-keyed (BPSK) communication system which is being used in the presence of a pulse-noise jammer.

The pulse-noise jammer transmits pulses of band-limited white Gaussian noise having a total average transmitted power (J). The jammer may choose the center frequency and the bandwidth of its jamming signal to be identical to the receiver center frequency and bandwidth. In addition, the jammer chooses its pulse duty factor (ρ) to cause maximum degradation to the communication link while maintaining its constant average transmitted power (J).

The bit error probability [2] of the coherent BPSK system is given by:

$$P_b = Q\left(\sqrt{\frac{2E_b}{N_0}}\right) \quad (4)$$

Where:

$$Q(x) = 0.5 * \text{erfc}(x/\sqrt{2})$$

E_b is the bit energy

N_0 is the one-sided thermal noise power spectral density of the receiver.

With jammer transmission, the noise jammer increases the receiver noise power spectral density from N_0 to $N_0 + N_j/\rho$. Where:

$N_j = J/W$ is the one-sided average jammer power spectral density

W is the bandwidth of the transmitted signal (the transmission bandwidth).

The bandwidth of the transmitted signal is:

$$W = B_{\text{message}} \approx R \quad \text{Without spreading (BPSK only)} \quad (5)$$

$$W = B = K * B_{\text{message}} \quad \text{After spreading (BPSK-SS)} \quad (6)$$

When the jammer transmits using duty factor (ρ), the average bit error probability will be given by:

$$\bar{P}_b = (1 - \rho)Q\left(\sqrt{\frac{2E_b}{N_0}}\right) + \rho Q\left(\sqrt{\frac{2E_b\rho}{N_0 + N_j/\rho}}\right) \quad (7)$$

When the system is being designed to operate in a jamming environment, the maximum possible transmitter power is generally used and the thermal noise N_0 can be safely neglected. Therefore, the first term in equation (7) can be neglected and consequently, \bar{P}_b can be approximated by:

$$\bar{P}_b = \rho Q\left(\sqrt{\frac{2E_b\rho}{N_j}}\right) \quad (8)$$

For large values of E_b/N_j , the Q-function can be approximated by an exponential yielding:

$$\bar{P}_b = \frac{\rho}{\sqrt{4\pi E_b\rho/N_j}} e^{-E_b\rho/N_j} \quad (9)$$

The aim of the jammer is to maximize \bar{P}_b . This can be found by calculating the maximum value of duty factor (ρ_{max}) and then, substituting in equation (9). ρ_{max} can be calculated by taking the first derivative of \bar{P}_b and setting the derivative value to zero.

Therefore:

$$\rho_{\text{max}} = N_j/2E_b \quad (10)$$

Hence, the maximum value of the average bit error probability, $\bar{P}_{b,\text{max}}$, is given by:

$$\bar{P}_{b,\text{max}} \approx \frac{1}{\sqrt{2\pi e}} \frac{1}{2E_b/N_j} \quad (11)$$

Since the duty factor ρ must be less than or equal to unity, equation (11) can be applied only at ρ_{max} when $E_b/N_j=0.5$.

Observe that the exponential relationship between the bit error probability and the signal to noise ratio in equation (4) is replaced by a linear relationship in equation (11). Both of equation (4) and equation (11) are plotted in Fig. 4.

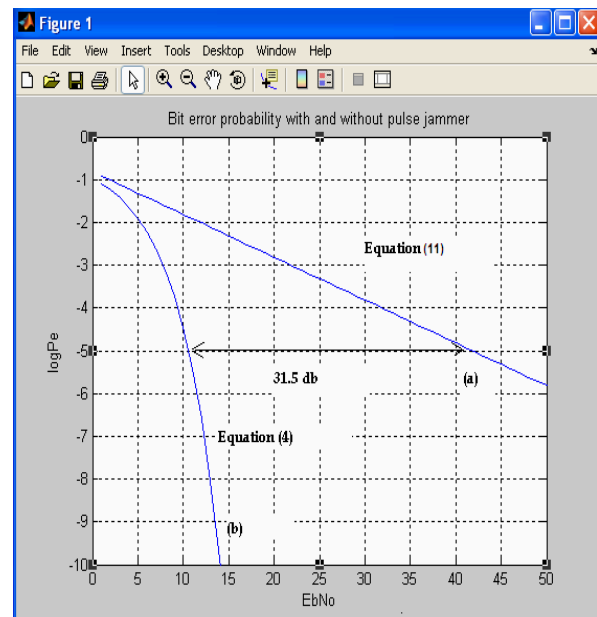

Fig. 4 Bit error probability

(a) Worst case pulse noise jammer (b) continuous-noise jammer

It is deduced from Fig. 4 that the pulse-noise jammer causes a performance degradation of approximately 31.5 dB at a bit error probability of 10^{-5} .

The severe degradation in the system performance, caused by the pulse-noise jammer, can be largely eliminated by using

a combination of spread spectrum techniques and the forward error correction coding with appropriate interleaving.

The effect of the spectrum spreading is the abscissa changing from E_b/N_j to $K*(E_b/N_j)$ since $K=W/R$ is the processing gain where $W=B$ is the transmission bandwidth of the spreading signal and R is the information rate.

Finally, observe that in order to cause maximum degradation, the jammer must know the value of E_b/N_j at the receiver which is difficult to obtain in the practical environments. Consequently, the results just described are the worst case. In addition, a real jammer would be limited in peak output power and it would not be able to use an arbitrary small duty factor. In spite of these limitations, the pulse jammer is a serious problem in military communication systems.

B. The Effect of Multipath

Although only a signal electromagnetic wave is radiated by a transmitting antenna, there are many instances in which that wave reaches the receiver by more than one path. The alternate paths involve reflections from the ionosphere, from the ground, or from the buildings and other objects along the propagation path. When more than one wave arrives at the receiving antenna, the net signal at the antenna is phase or sum separated waves. Fig. 5 illustrates this situation and shows the paths by which the radiation might reach the receiving antenna.

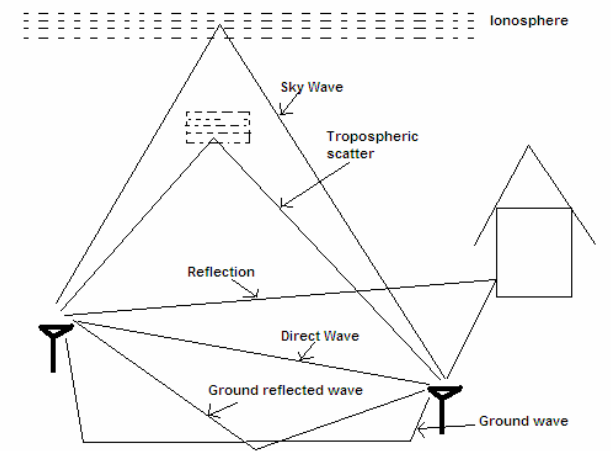

Fig. 5 Propagation paths over the earth surface

The effect of ground reflected wave arriving along with the direct wave is important in RF high precision ranging systems. The difficulty arises because the phases of the direct path and the reflected signals are different when they arrive at the receiving antenna. Multipath signal will affect the RF signals amplitude and phase and as a result, will interfere with range measurement. The multipath signal is another source of the unpredictable error.

The multiple rays are due to the presence of the reflectors and the scatterers around the receiver. Moreover, these multiple rays have randomly distributed amplitudes, phases and angles of arrival and they arrive at the receiver from

different directions at slightly different excess time delays with respect to each other. Also, they combine vectorially at the receiver antenna. When they are added constructively, the received signal is enhanced. While, in the contrary, when they are added destructively, their vectorial sum tends to small values. Then, as the receiver moves from position to position over small travel distance during small time interval, the resultant received signal will vary due to the changing of the environment structure around it. The rapid fluctuation in the amplitude of a received signal over a short period of time or small travel distance is called small scale fading. In a more serious case, a receiver may stop at a particular location at which the received signal is in a deep fade.

If there is no line of sight propagation path, the Rayleigh distribution is used to describe the statistical time varying nature of the envelope of the received signal. Even when a Line of sight between the transmitter and the receiver exists, the reflected and the scattered waves still occur due to reflections from the ground and the surrounding local structure. So, the indirect rays have envelopes that are Rayleigh. However, if there is a dominant stationary (non-fading) line of sight propagation path arrives with many weaker indirect rays, the envelope distribution of the received signal is Ricean.

The maximum number of paths (rays), which can be resolved in the frequency-selective fading channel, can be expressed by:

$$L_{\max} = \left\lceil \frac{B}{2 B_c} \right\rceil + 1 \quad (12)$$

Where:

B is the bandwidth of the transmitted signal
 B_c is the coherence bandwidth of the channel.

The spread spectrum modulation can mitigate the fading induced from the multipath propagation by using the RAKE receiver. The basic idea of the RAKE receiver was first proposed by Price and Green (1958). The RAKE receiver does just this – it attempts to collect the time-shifted versions of the original signal by providing a separate correlator for each of the multipath signals. Moreover, the RAKE receiver can achieve the multipath diversity, depending on the fact that the multipath components (the rays) are practically uncorrelated when their relative propagation delays exceed a chip period. Thus, the system performance improves [9].

IV. SYSTEM MODEL

In this paper, M-ary signaling scheme for direct sequence spread spectrum system as shown in Fig. 6, is proposed and analyzed when the system is designed with or without RNS and the channel is assumed to inflict additive white Gaussian noise (AWGN).

The bit error probability (P_e) [2] is used as a reference for comparisons between various schemes.

$$P_e = Q[\sqrt{(2E_b/N_0)}] \quad , M = 2 \quad (13)$$

$$P_e = (1/\log_2(M)) * Q[\sqrt{(2E_b/N_0)}] * \text{Sin}(\pi/M) \quad , M > 2 \quad (14)$$

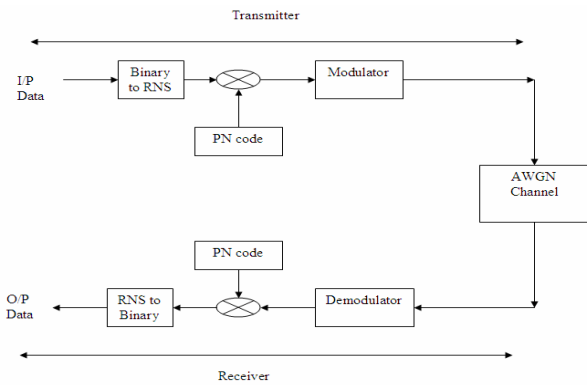

Fig. 6 RNS Direct Sequence Spread Spectrum System

Numerical results show that, when the RNS is applied using a moderate number of redundant moduli, we can improve the bit error rate (BER) performance of the proposed system.

V. BASIC DEFINITIONS

A. Residue Number System (RNS)

A residue number system (RNS) [10 - 11] represents a large integer using a set of smaller integers, so that computation may be performed more efficiently. It relies on the Chinese remainder theorem (CRT) [4] of modular arithmetic for its operation, a mathematical idea from Sun Tsu Suan-Ching (Master Sun's Arithmetic Manual) in the 4th century AD.

The residue number system is defined by the choice of v positive integers m_i ($i = 1, 2, 3 \dots v$) referred to as moduli. If all the moduli are pair-wise relative primes, any integer N , describing a non-binary message in this letter, can be uniquely and unambiguously represented by the so-called residue sequence $(r_1, r_2 \dots r_v)$ in the range $0 < N < M_1$, where $r_i = N \pmod{m_i}$ represents the residue digit of N upon division by m_i , and $M_1 = \prod m_i$ is the information symbols' dynamic range. Conversely, according to the Chinese Remainder Theorem, for any given v -tuple $(r_1, r_2 \dots r_v)$ where $0 \leq r_i < m_i$; there exists one and only one integer N such that $0 \leq N < M_1$ and $r_i = N \pmod{m_i}$ which allows us to recover the message N from the received residue digits.

Residue number system [10 - 13] has two inherent features that render the RNS attractive in comparison to conventional weighted number systems, such as for example the binary representation. These two features are [11]:

- The carry-free arithmetic and,
- Lack of ordered significance amongst the residue digits.

The first property implies that the operations related to the individual residue digits of different moduli are mutually independent because of the absence of carry information. The second property of the RNS arithmetic implies that some of the residue digits can be discarded without affecting the result, provided that a sufficiently "high dynamic range" is retained in the "reduced" system in order to unambiguously contain the result, as argument below.

B. Pseudo Number (PN) Generator

PN is the key factor in DS-SS systems (Fig 1). A *Pseudo Noise* or *Pseudorandom* sequence is a binary sequence with an autocorrelation that resembles, over a period, the autocorrelation of a random binary sequence. It is generated using a Shift Register, and a Combinational Logic circuit as its feedback. The Logic Circuit determines the PN words.

Due to the usage of the PN code, the spread spectrum technique has the ability to discriminate interference signals and detect the received signal by matching received PN code with the local PN code and measuring the number of chips of the code delay between the signal being transmitted and received, and thus determine uniquely the range from the transmitter to the receiver without ambiguity [3]. Consequently the spread spectrum technique has its advantage in that its phase is easily resolved.

There are three basic properties that can be applied to a periodic binary sequence (PN sequence) as a test of the appearance of randomness, they are:

1. *Balance Property*: Good balance requires that in each period of the sequence, the number of binary *Ones* differs from the number of binary *Zeros* by at most one digit.
2. *Run Property*: A run is defined as: sequence of a single type of binary digits. The appearance of the alternate digit in a sequence starts a new run. It is desirable that about one half the runs of each type is of length 1, about one fourth of length 2, one eighth is of length 3, and so on.
3. *Correlation Property*: If a period of the sequence is compared term by term with any cyclic shift of itself, it is best if the number of agreements differs from the number of disagreements by not more than one count.

The PN (Pseudo Noise) codes used for DSSS require certain mathematical properties.

1. *Maximum Length Sequences*: These are PN sequences that repeat every $2^n - 1$, where n is an integer. These sequences can be implemented using shift registers. The PN sequences must exhibit good correlation properties. Two such sequences are Barker Codes, and Willard Codes.

2. *Maximum Auto-Correlation*: When the received signal is mixed with locally generated PN sequence, it must result in maximum signal strength at the point of synchronization.

3. *Minimum Cross-Correlation*: When the received signal with a different PN sequence than that of the receiver, is mixed with the locally generated PN sequence, it must result in minimum signal strength. This would enable a DSSS receiver to receive only the signal matching the PN code. This property is known as Orthogonality of PN Sequences.

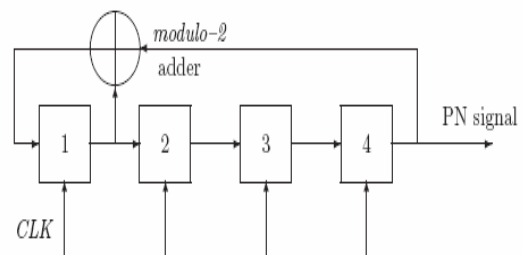

Fig. 7 (a) PN Generator block diagram m-sequence code

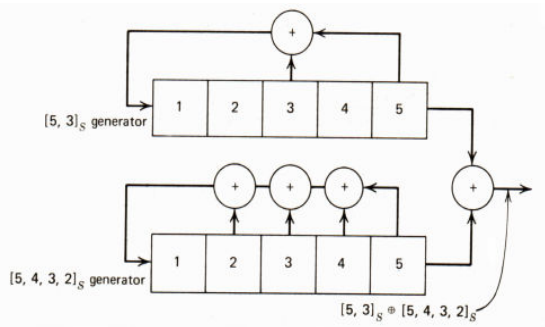

Fig. 7 (b) PN Generator block diagram Gold code

In this paper, the so called *Maximum-Length* PN sequence is used, generated by a linear feedback shift register, which has a feedback logic of only *modulo-2 adders* (XOR Gates).

C. The Channel

The channel is simulated using additive white Gaussian noise distribution.

The AWGN channel is considered a good model for many satellite and deep space communication links. It is not a good model for most terrestrial links because of multipath, terrain blocking, interference, etc. However, for terrestrial path modeling, AWGN is commonly used to simulate background noise of the channel under study, in addition to multipath, terrain blocking, interference, ground clutter and self interference that modern radio systems encounter in terrestrial operation.

The relative power of noise in an AWGN channel is typically described by quantities such as:

- Signal-to-noise ratio (SNR) per sample.
- Ratio of bit energy to noise power spectral density (E_b/N_0).
- Ratio of symbol energy to noise power spectral density (E_s/N_0)

The relationship between E_s/N_0 and E_b/N_0 , expressed in dB, as follows:

$$E_s/N_0 = E_b/N_0 + 10\log_{10}k \quad (15)$$

Where:

k is the number of information bits per symbol.

The relationship between E_s/N_0 and SNR, expressed in dB, as follows:

$$E_s/N_0 = 10\log(T_{sym}/T_{samp}) + SNR \quad (16)$$

Where:

T_{sym} is the signal's symbol period

T_{samp} is the signal's sampling period

VI. SIMULATION RESULTS

Various simulations were performed for the Spread spectrum transmit / receive system with and without RNS.

The bit error probability is used as a way of comparison between different scenarios.

A. Using Matlab Simulink Function

- System bandwidth effect

Varying the channel bandwidth, the BER changes as shown in Fig 8.

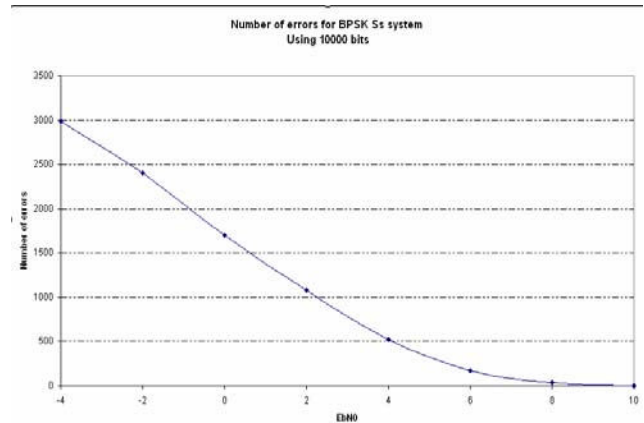

Fig. 8 Number of errors for BPSK Ss systems Vs E_b/N_0

It is clear from Fig 8 that increasing the channel B.W and the signal to noise ratio, both improve the system performance and decrease the number of error per bit.

- Effect of various PN sequences

Studying the autocorrelation values for various PN sequences [7], the following autocorrelation results were generated:

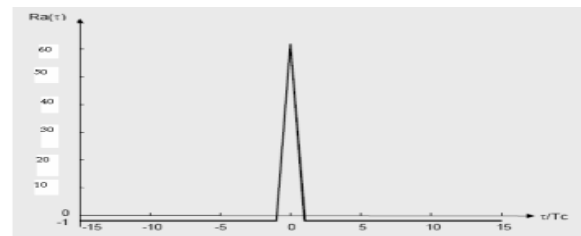

Fig. 9 (a) M - sequence autocorrelation

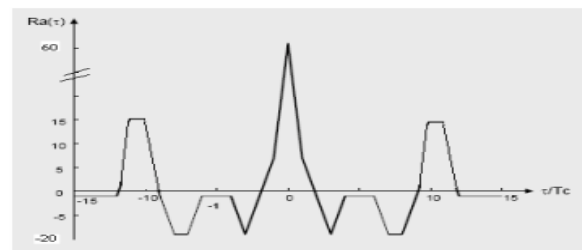

Fig. 9 (b) Gold - sequence autocorrelation

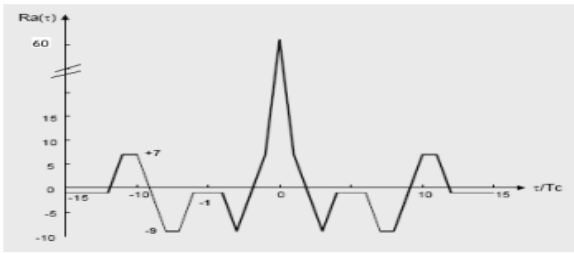

Fig. 9 (c) Kasami - sequence autocorrelation

From Fig. 9, the PN sequences is considered best suited for synchronization because the autocorrelation takes on just two values.

- Effect of Multipath:
 Varying the number of paths, and measuring the BER.

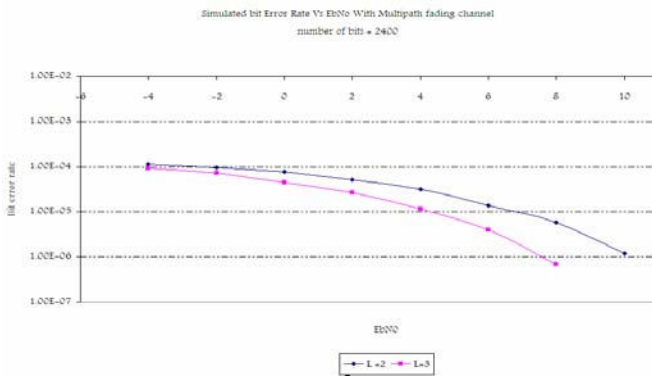

Fig. 10 Tx / Rx Spread Spectrum system with Raleigh distribution

From Fig. 10, it is shown that increasing the number of paths improves the system performance and decreases the number of error per bit.

B. Using Generated Matlab m-files

- Simulating the effect of M-ary modulation on the system performance:

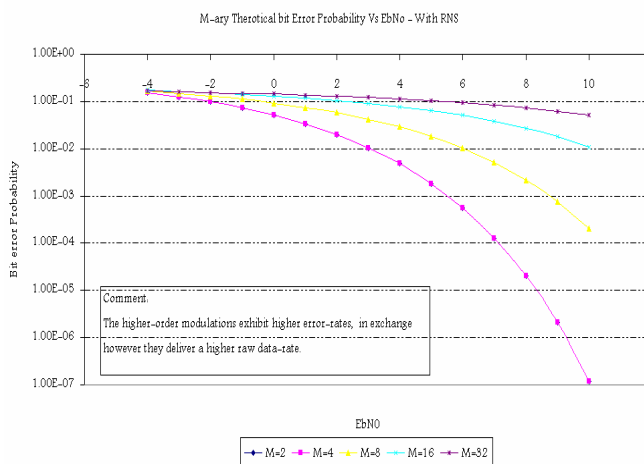

Fig. 11 (a) Effect of different m-ary system with RNS

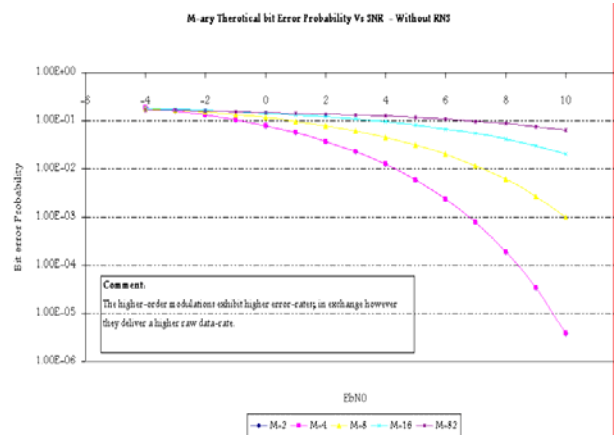

Fig. 11 (b) Effect of different m-ary system without RNS

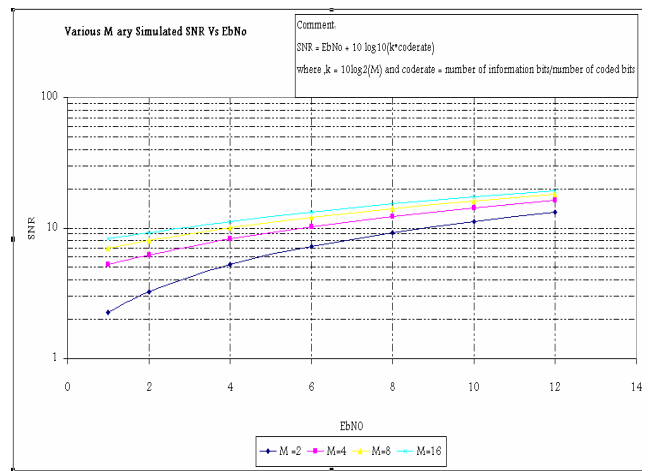

Fig. 11 (c) SNR Vs EbNo for various m-ary system

From Fig. 11, it is shown that the higher-order modulations exhibit higher error-rates, in exchange however they deliver a higher raw data-rate.

- Simulating the effects of the PN signal rates

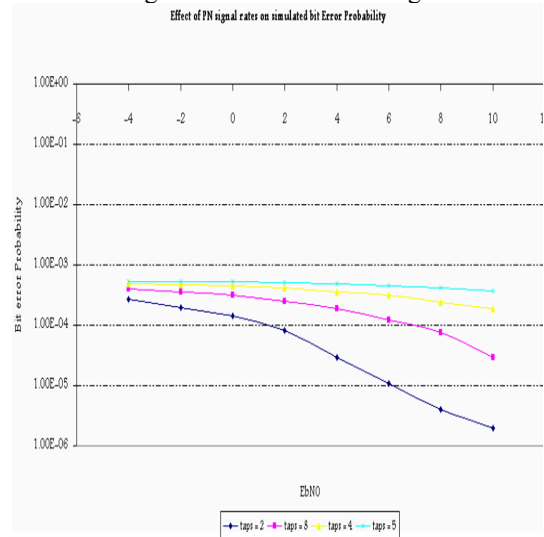

Fig. 12 Effect of different PN sequences on BER probability

Observe in Fig 12 the effects of the PN code rate to the output bit error probability. The simulations showed that the PN signal rate had no significant effect improvement of bit error probability. This supports the conclusion that the spectrum spreading and de-spreading process have no contribution in reducing the white noise.

- Simulating the effect channel B.W on the system performance:

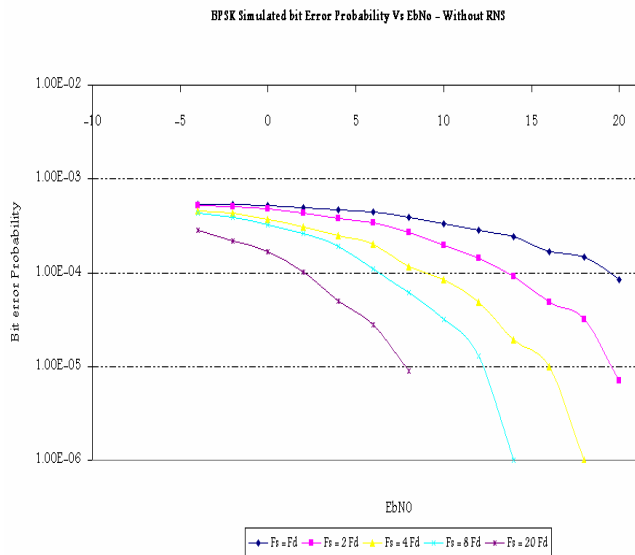

Fig. 13 Effect of various B.W on BER probability

Increasing the B.W improves the bit rate probability of the system as shown in Fig. 13.

- Simulating the effect RNS on the system performance:

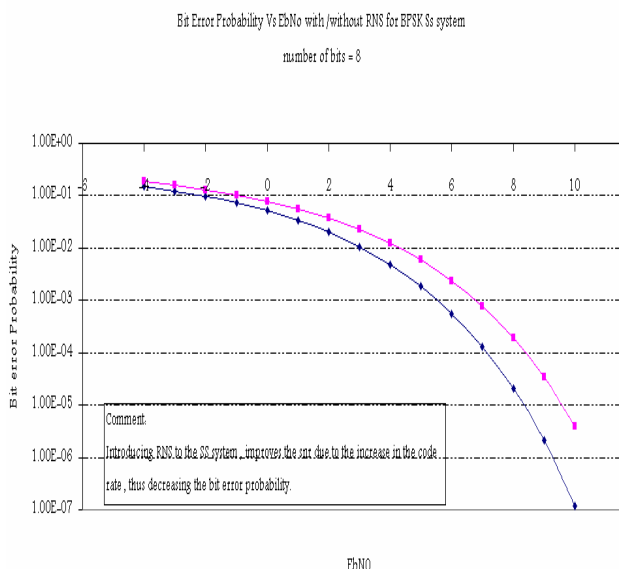

Fig. 14 Effect of RNS on BER probability

It is deduced from Fig. 14 that the use of RNS causes a performance improvement of approximately 2 dB at a bit error

probability of 10^{-5} .

VII. CONCLUSION AND FUTURE WORK

From the above simulations the following results were obtained:

- Increasing the channel bandwidth, improves the bit error probability.
- The PN sequences are considered best suited for synchronization because the autocorrelation takes on just two values. The Gold and Kasami sequences provide a larger number of sequences with good cross-correlation properties than do the PN sequences.
- The performance of DS-CDMA system was improved with an increasing number of diversity paths, when the channel was the multipath fading channel.
- It's shown that higher-order modulations exhibit higher error-rates, in exchange however they deliver a higher raw data-rate.
- Finally, introducing RNS to the SS system improves the signal-to-noise ratio due to the increase in the code rate, thus decreasing the bit error probability.

Next, implement the above system for geostationary satellite orbit determination, discussing its capabilities and potentials.

REFERENCES

- [1] N.B chakrabarti, A. K. Datta, "introduction to the principles of digital communication", New Age Publishers, 2007.
- [2] Erik Storm, Tony Ottosson, Arne Svensson, "An introduction to spread spectrum systems", Department of signals and systems, Chalmers university of technology, Sweden, 2002.
- [3] Raymond L. PICKHOLTZ, "Theory of spread spectrum communication – A tutorial", IEEE Trans. Communication, vol. 30, No.5, May 1982.
- [4] Ryuji Kohno, Reuven Meidan, and Laurence B. Milstein, "Spread Spectrum Access Methods for Wireless Communications", IEEE Communication magazine, January 1995.
- [5] Yong Luo, "Spread Spectrum Ranging System – Analysis and Simulation", Master Thesis in Electronic systems engineering – University of Regina, Saskatchewan, March 1998.
- [6] G. Harles, J. Wouters, B. Fritzsche, F. Haiduk, "Operational Aspects of an Innovative, DVB-S based, Satellite Ranging Tool", SES ASTRA, Fraunhofer Institute for Integrated Circuits, Branch Lab EAS, Dresden/Germany - SpaceOps Conference 2004.
- [7] Ipsita Bhanja, "Performance comparison of various spreading codes in spread spectrum modulation in ranging technique", Proc of national conference on range technology, pp30-35, 2006
- [8] Carl Andren, "A Comparison of Frequency Hopping and Direct Sequence Spread Spectrum Modulation for IEEE 802.11 Applications at 2.4 GHz" Harris Semiconductor, Palm Bay, Florida Nov. 1997.
- [9] Lie-Liang, Lajos Hanzo, "Performance of residue number system based DS-CDMA over multipath fading channels using orthogonal sequences", department of electronics and computer science, university of Southampton, UK, July 1999.
- [10] K. W. Watson, "Self-checking computations using residue arithmetic," Proc. IEEE, vol. 54, pp. 1920–1931, Dec. 1966.
- [11] K. W. Watson, "Self-checking computations using residue arithmetic," Proc. IEEE, vol. 54, pp. 1920–1931, Dec. 1966.
- [12] E. D. D. Claudio, G. Orlandi, and F. Piazza, "A systolic redundant residue arithmetic error correction circuit," IEEE Trans. Computers, vol. 42, pp. 427–432, Apr. 1993.
- [13] H. Krishna and J. D. Sun, "On theory and fast algorithms for error correction in residue number system product codes," IEEE Trans. Computers, vol. 42, pp. 840–852, July 1993.