

# Small Signal Stability Assessment Employing PSO Based TCSC Controller with Comparison to GA Based Design

D. Mondal, A. Chakrabarti and A. Sengupta

**Abstract**—This paper aims to select the optimal location and setting parameters of TCSC (Thyristor Controlled Series Compensator) controller using Particle Swarm Optimization (PSO) and Genetic Algorithm (GA) to mitigate small signal oscillations in a multimachine power system. Though Power System Stabilizers (PSSs) are prime choice in this issue, installation of FACTS device has been suggested here in order to achieve appreciable damping of system oscillations. However, performance of any FACTS devices highly depends upon its parameters and suitable location in the power network. In this paper PSO as well as GA based techniques are used separately and compared their performances to investigate this problem. The results of small signal stability analysis have been represented employing eigenvalue as well as time domain response in face of two common power system disturbances e.g., varying load and transmission line outage. It has been revealed that the PSO based TCSC controller is more effective than GA based controller even during critical loading condition.

**Keywords**—Genetic Algorithm, Particle Swarm Optimization, Small Signal Stability, Thyristor Controlled Series Compensator.

## I. INTRODUCTION

LOW frequency power oscillations are the challenging problem in interconnected power systems. These oscillations may sustain and grow to cause system separation if no adequate damping is available [1]. Conventionally, additional damping in system is introduced by the application of PSS [2], [3]. With the development of FACTS [4], researchers paid much attention to this device to not only improve the damping of power system oscillations but also to enhance the system power transfer capability. In [5] Unified power flow controller (UPFC), a modern FACTS device has been used to introduce adequate damping in power system network with changing system conditions. Thyristor Controlled Series Compensator (TCSC), a series controlled FACTS device has been proven to be very robust and effective means for this purpose in long transmission lines of modern power systems [6], [7].

The optimal placement of FACTS controller in power system networks has been reported in literatures based on different aspects. A method to obtain optimal location of TCSC has been suggested in [8] based on real power performance index and reduction of system VAR loss. In [9]

optimal allocation of SVC using Genetic Algorithm (GA) has been introduced to achieve the optimal power flow (OPF) with lowest cost generation in power system.

But the optimal allocations of TCSC controller using PSO to investigate the small signal oscillations have not been discussed in existing literature. In this paper this fact has been taken into consideration as well as a PSO based technique is proposed to place TCSC controller in a multimachine system in order to damp the small signal oscillations.

It is a well known fact that optimal parameter tuning of power system analysis controller is a complex exercise. The conventional techniques reported in the literatures [10], [11] are time consuming, require heavy computation burden and they have slow convergence rate too. Many stochastic search methods have been developed for global optimization problems, such as artificial neural network, genetic algorithm and evolutionary programming [12], [13].

Recently, Particle Swarm Optimization (PSO) method, developed by Kennedy and Eberhart [14] has appeared as a promising algorithm for handling the optimization problems. PSO is a robust, non-linear and population based stochastic optimization technique which can generate high-quality solutions within shorter calculation time and has more stable convergence characteristics than other stochastic methods. Though attempts have been made in several research papers [15], [16] for the design of optimal FACTS controllers using PSO, the applications are mostly limited to the case of single machine infinite bus system.

In this paper, both PSO and the GA based techniques are used to search the best location and the parameters of TCSC controller and the application is extended to study the small-signal oscillation problem in case of a multimachine power system.

The paper is organized as follows: section II describes the small signal modeling of the multimachine system with TCSC controller. The desired objective function and the optimization problem have been formulated in section III. Overview of PSO and GA with proposed parameter optimization algorithm has been discussed in section IV. In section V, the TCSC controller parameters and its optimal location are identified separately by both algorithms and subsequently the applications of PSO and the GA based TCSC controllers have been illustrated following power system disturbances. Finally, comparisons between PSO and the GA based results have been drawn in section VI.

D. Mondal is with the Department of Electronics and Instrumentation Engineering, Haldia Institute of Technology, Purba Medinipur, Haldia-721657, India (mondald12@yahoo.in)

A. Chakrabarti and A. Sengupta are with the Department of Electrical Engineering, Bengal Engineering and Science University, Howrah-711103, India (e-mail: a\_chakrabarti55@yahoo.com and sgaparajita@gmail.com).

## II. SYSTEM MODELING

### A. Modeling of TCSC

The basic TCSC module and the transfer function model of a TCSC controller [17] have been shown in Fig. 1(a) and 1(b) respectively. This simple model utilizes the concept of a variable series reactance which is adjusted through appropriate variation of the firing angle ( $\alpha$ ). The controller comprises of a gain block, a signal washout block and a phase compensator block. The input signal is the normalized speed deviation ( $\Delta v$ ), and output signal is the stabilizing signal (i.e. deviation in conduction angle,  $\Delta\sigma$ ). Neglecting washout stage, the TCSC controller model can be represented by the following state equations:

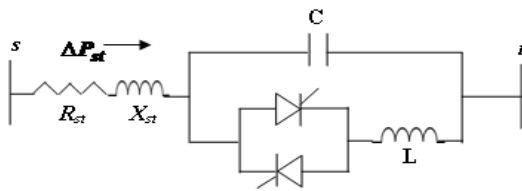

Fig. 1(a) TCSC module

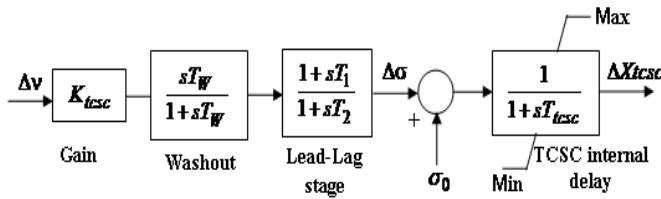

Fig. 1(b) Block diagram of a TCSC based controller

$$\Delta\dot{\alpha} = -\frac{1}{T_2}\Delta\alpha - \frac{K_{tcsc}}{\omega_s} \left( \frac{1}{T_2} \right) \Delta\omega - \frac{K_{tcsc}}{\omega_s} \left( \frac{T_1}{T_2} \right) \Delta\dot{\omega} \quad (1)$$

$$\Delta\dot{X}_{tcsc} = -\frac{1}{T_{tcsc}}\Delta\alpha - \frac{1}{T_{tcsc}}\Delta X_{tcsc} \quad (2)$$

The linearized TCSC equivalent reactance can be obtained by the following relationship [18]:

$$\Delta X_{tcsc} = \left\{ -2C_1(1 + \cos(2\alpha)) + C_2 \sin(2\alpha)(\omega \tan(\omega(\pi - \alpha)) - \tan \alpha) + C_2 \left( \omega^2 \frac{\cos^2(\pi - \alpha)}{\cos^2(\omega(\pi - \alpha))} - 1 \right) \right\} \Delta\alpha \quad (3)$$

$$\text{where, } C_1 = \frac{X_C + X_{LC}}{\pi}, \quad C_2 = \frac{4X_{LC}^2}{\pi X_L} \quad \text{and } X_{LC} = \frac{X_C X_L}{X_C - X_L}$$

### B. Multimachine Model with TCSC

The small signal modeling of a multimachine system with IEEE-Type I exciter has been described in [19]. All equations relating to the performance of the machine with exciter and network power flow were linearized around the nominal operating condition to obtain the dynamic model of the system for eigenvalue analysis and are represented by the following state-space equations

$$\Delta\dot{X} = A_1\Delta X + B_1\Delta I_g + B_2\Delta V_g + E_1\Delta U \quad (4)$$

$$0 = C_1\Delta X + D_1\Delta I_g + D_2\Delta V_g \quad (5)$$

$$0 = C_2\Delta X + D_3\Delta I_g + D_4\Delta V_g + D_5\Delta V_l \quad (6)$$

$$0 = D_6\Delta V_g + D_7\Delta V_l \quad (7)$$

Here (4) and (5) represent the linearized differential equations and linearized stator algebraic equations of the machine, while (6) and (7) correspond to the linearized network equations pertaining to the generator buses and the load buses. The multimachine linearized model with TCSC controller has been formulated by adding the state variables ( $\Delta X_{tcsc} = [\Delta\alpha \quad \Delta X_{tcsc}]^T$ ) corresponding to the TCSC controller with (4)-(6) and the TCSC power flow equations are included in the network equation (7). The TCSC linearized power flow equations at the node  $s$  can be obtained by the following expression

$$0 = \begin{bmatrix} \frac{\partial P_s}{\partial \theta_s} & \frac{\partial P_s}{\partial V_s} & \frac{\partial P_s}{\partial \alpha} \\ \frac{\partial Q_s}{\partial \theta_s} & \frac{\partial Q_s}{\partial V_s} & \frac{\partial Q_s}{\partial \alpha} \\ \frac{\partial P_{st}}{\partial \theta_s} & \frac{\partial P_{st}}{\partial V_s} & \frac{\partial P_{st}}{\partial \alpha} \end{bmatrix} \begin{bmatrix} \Delta\theta_s \\ \Delta V_s \\ \Delta\alpha \end{bmatrix} \quad (8)$$

$$\text{where } P_{st} = V_s^2 g_{st} - V_s V_t (g_{st} \cos \delta_{st} + b_{st} \sin \delta_{st}) \quad (9)$$

$$\text{and } Q_{st} = -V_s^2 b_{st} - V_s V_t (g_{st} \sin \delta_{st} - b_{st} \cos \delta_{st}) \quad (10)$$

Similarly, the equations for the node  $t$  can be obtained by replacing  $s$  by  $t$ .

$$\text{Here, } Y_{st}^* = \frac{1}{R_{st} + j(X_{st} - X_{TCSC})} = \frac{R_{st} + j(X_{st} + X_{TCSC})}{R_{st}^2 + (X_{st} + X_{TCSC})^2} = g_{st} - jb_{st} \quad (11)$$

$$\text{and } \frac{\partial P_s}{\partial \alpha} = -\frac{\partial P_{st}}{\partial \alpha} = -V_s^2 \frac{\partial g_{st}}{\partial \alpha} + V_s V_t (\cos \delta_{st} \frac{\partial g_{st}}{\partial \alpha} + \sin \delta_{st} \frac{\partial b_{st}}{\partial \alpha}) \quad (12)$$

Also  $\frac{\partial P_{st}}{\partial \theta_s} = -\frac{\partial P_s}{\partial \theta_s}$  and  $\frac{\partial P_{st}}{\partial V_s} = -\frac{\partial P_s}{\partial V_s}$ . The expression for

$\frac{\partial g_{st}}{\partial \alpha}$  and  $\frac{\partial b_{st}}{\partial \alpha}$  can be obtained from (11).

Eliminating  $\Delta I_g$  from (4)-(6), the overall system matrix for an  $m$ -machine system can be obtained as

$$[A_{tcsc}]_{(7m+2) \times (7m+2)} = [A'] - [B'] [D']^{-1} [C'] \quad (13)$$

$$\text{where } A' = A_1 - B_1 D_1^{-1} C_1, \quad B' = [B_2 - B_1 D_1^{-1} D_2 \quad 0],$$

$$C' = \begin{bmatrix} K_2 \\ 0 \end{bmatrix} \quad \text{and } D' = \begin{bmatrix} K_1 & D_5 \\ D_6 & D_7 \end{bmatrix} \quad \text{with } K_1 = [D_4 - D_3 D_1^{-1} D_2]$$

$$\text{and } K_2 = [C_2 - D_3 D_1^{-1} C_1].$$

Therefore, linear zed state-space model of the multimachine system with TCSC controller can be expressed as

$$\Delta\dot{X} = A_{tcsc}\Delta X + E_1\Delta U \quad (14)$$

$$\Delta Y = C\Delta X \quad (15)$$

### III. PROBLEM FORMULATION

#### A. Objective Function and Optimization Problem

The optimization problem represented here is to search the optimal location and the parameter set of the TCSC controller using PSO and GA algorithms. It is worth mentioning that the TCSC controller is designed to minimize the power system small signal oscillations after a disturbance so as to improve the stability. This results in minimization of the critical damping index (*CDI*) given by:

$$CDI = J = (1 - \zeta_i) \quad (16)$$

Here,  $\zeta_i = -\sigma_i / \sqrt{\sigma_i^2 + \omega_i^2}$  is the damping ratio of the *i*-th critical swing mode. The objective of the optimization is to maximize the damping ratio ( $\zeta$ ) as much as possible. There are four tuning parameters of the TCSC controller; the controllers gain ( $K_{tcsc}$ ), lead time constant ( $T_1$ ), lag time constant ( $T_2$ ) and the location number ( $N_{loc}$ ). These parameters are to be optimized by minimizing the objective function *J* given by (16). With the change of locations and parameters of the TCSC controller the damping ratio ( $\zeta$ ) as well as *J* varies. The problem constraints are the bounds on the possible locations and parameters of the TCSC controller. The optimization problem can then be formulated as:

Minimize *J* (17)

Subject to constraints

$$K_{tcsc}^{min} \leq K_{tcsc} \leq K_{tcsc}^{max}$$

$$T_1^{min} \leq T_1 \leq T_1^{max}$$

$$T_2^{min} \leq T_2 \leq T_2^{max}$$

$$N_{loc}^{min} \leq N_{loc} \leq N_{loc}^{max}$$

### IV. OPTIMIZATION ALGORITHMS

#### A. Particle Swarm Optimization (PSO)

Particle Swarm Optimization was first developed in 1995 by Eberhart and Kennedy [14]. The algorithm begins by initializing a random swarm of *M* particles, each having *R* unknown parameters to be optimized. In each iteration, the fitness of each particle is evaluated according to the selected fitness function. The algorithm stores and progressively replaces the best fit parameters of each particle ( $pbest_i$ ,  $i=1, 2, 3, \dots, M$ ) as well as a single most fit particle ( $gbest$ ) among all the particles in the group. The trajectory of each particle is influenced in a direction determined by the previous velocity and the location of  $gbest$  and  $pbest_i$ . Each particle's previous position ( $pbest_i$ ) and the swarm's overall best position ( $gbest$ ) are meant to represent the notion of individual experience memory and group knowledge of a "leader" respectively. The parameters of each particle ( $p_i$ ) in the swarm are updated in each iteration (*n*) according to the following equations:

$$vel_i(n) = w \times vel_i(n-1) + acc_1 \times rand_1 \times (gbest - p_i(n-1)) + acc_2 \times rand_2 \times (pbest_i - p_i(n-1)) \quad (18)$$

$$p_i(n) = p_i(n-1) + vel_i(n) \quad (19)$$

where,  $vel_i(n)$  is the velocity vector of particle *i*.  $acc_1, acc_2$  are the acceleration coefficients that pull each particle towards  $gbest$  and  $pbest_i$  positions respectively and are often set in the range  $\in (0,2)$ . *w* is the inertia weight of values  $\in (0,1)$ .  $rand_1$  and  $rand_2$  are two uniformly distributed random numbers in the ranges  $\in (0,1)$ .

#### 1. Algorithms for Implemented PSO

To optimize (16), routines from PSO toolbox [20] are used. The objective function corresponding to each particle is evaluated by the eigenvalue analysis program of the proposed test system shown in Appendix (Fig. A.1). The particle is defined as a vector which contains the TCSC controller parameters and the location number:  $K_{tcsc}, T_1, T_2$  and  $N_{loc}$ . The initial population is generated randomly for each particle and is kept within a typical range. The values of the TCSC parameters and the location numbers are updated in each generation within this specified range. It is to be noted that TCSC location numbers are updated only for the set of specific branch indexes. The particle configuration corresponding to the TCSC controller is shown in Fig 2.

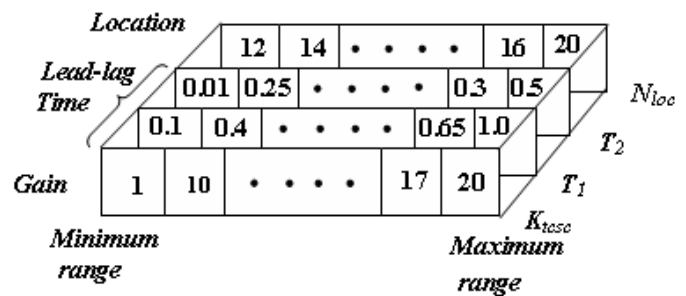

Fig. 2 Particle configuration for TCSC controller

Here first string corresponds to the TCSC controller gain, second and third strings for lead and lag time constants and fourth contain the number of transmission line where the TCSC is to be located. The network branches (line #12, 13, 14, 15, 16, 17, 18, 19 and 20) between two load buses (Fig. A.1) are chosen here for possible installing locations of the TCSC and therefore, the line #12 and line #20 are assigned for  $N_{loc}^{min}$  and  $N_{loc}^{max}$  respectively. The computational flow chart of the implemented PSO has been shown in Fig. 3.

#### B. Overview of Genetic Algorithm (GA)

Genetic algorithms (GAs) [21] are essentially global search algorithms based on the mechanisms of natural selection and genetics. It has been used for optimizing the parameters of the control system that are complex and difficult to solve by conventional optimisation methods. GA maintains a set of candidate solutions called population and repeatedly modifies them. At each step, the GA selects individuals from the current population to be parents and uses them to produce the children for the next generation. Candidate solutions are usually represented as strings of fixed length, called chromosomes. A

fitness or objective function is used to reflect the goodness of each member of the population. The GAs start with random generation of initial population and then the selection, *crossover* and *mutation* are preceded until the maximum generation is reached.

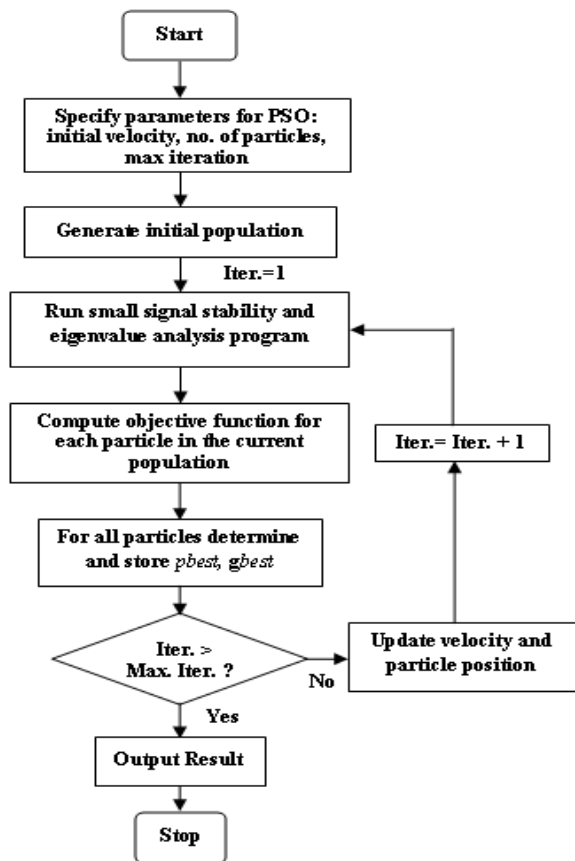

Fig. 3 Flow chart of the implemented PSO

### 1. Algorithms for Implemented GA

The objective is to find the optimal locations and parameters for the TCSC controller within the inequality constraints given in section III. The individuals for the TCSC device have been configured following similar procedure as described for particle configuration in PSO. Each individual is encoded by four parameters: the controller gain ( $K_{tsc}$ ), lead and lag time constants ( $T_1$ ,  $T_2$ ) and the TCSC location number ( $N_{loc}$ ). The range of minimum and maximum values of these parameters has been kept identical with the particle configuration for PSO (Fig. 2). The entire initial population of size  $N_{ind}$  has been calculated by repeating the individuals for  $N_{ind}$  times and shown in Fig. 4.

The algorithms of the implemented GA have been described here in following steps;

Step 1: Specify parameters for GA: population size, generation limit, number of variables etc.

Step 2: Generate initial population for TCSC controller parameters:  $K_{tsc}$ ,  $T_1$ ,  $T_2$  and  $N_{loc}$ .

Step 3: Run small signal stability and eigenvalue analysis program for the proposed test system.

Step 4: Evaluate objective function ( $J$ ) for each individual in the current population.

Step 5: Determine and store best individual which minimizes the objective function.

Step 6: Check whether the generation exceeds maximum limit/stall generation limit.

Step 7: If generation  $\leq$  max. limit, update population for next gen. by crossover and mutation and repeat from step 3.

Step 8: If generation  $>$  max. limit, stop program and produce output.

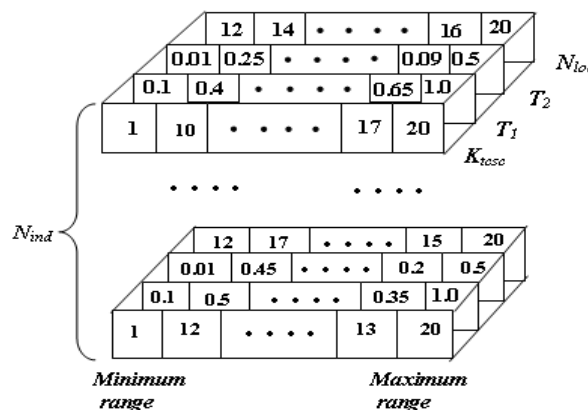

Fig. 4 Calculation of the entire population

## V. RESULTS AND PERFORMANCE STUDY

### A. Application of PSO and GA in the Test System

The validity of the proposed PSO and the GA algorithms has been tested here on an IEEE-14 bus system (Fig. A.1). This system has also been used widely in the literature [22] for small signal stability analysis. In order to study the small signal performance of the system the simulation is carried out for two independent types of disturbances: (i) real and reactive load increased at a particular bus # 9 (15 % more than nominal case) (ii) outage of a transmission line (# 4-13). The swing modes of the system without TCSC dynamics are listed in Table I.

TABLE I  
SWING MODES WITHOUT TCSC

#	Load increased at bus # 9 ( $P_L=0.339$ pu, $Q_L=0.190$ pu)		Transmission line (# 4 - 13) outage	
	Swing modes	Damping ratio	Swing modes	Damping ratio
1	$-1.5446 \pm j7.5274$	0.2010	$-1.5482 \pm j7.5222$	0.2015
2	$-1.4244 \pm j6.5313$	0.2130	$-1.4291 \pm j6.5339$	0.2136
3	$-1.1590 \pm j6.1460$	0.1853	$-1.1501 \pm j6.1659$	0.1833
4	$-0.8831 \pm j5.8324$	0.1497	$-0.8845 \pm j5.8336$	0.1499

It has been observed that the swing mode # 4 is the critical one as the damping ratio of this mode is smallest compared to other modes. Therefore, stabilization of this mode is essential in order to improve small signal stability.

The objective function given by (16) is evaluated by small signal analysis program of the proposed test system. All the loads are assumed to be of constant power type. The nodal voltage magnitudes and angles were solved by the conventional N-R load flow while a separate subprogram was solved at the end of each iteration to update the state variables for the FACTS in order to meet the specified line-flow criteria. The transmission line compensation ( $X_{tcsc} / X_{line}$ ) is kept to be around 60 % for each of the selected lines and therefore  $X_L$ ,  $X_C$  and  $\alpha$  for the TCSC are chosen according to the line reactance. The initial value of the firing angle ( $\alpha$ ) of the TCSC is kept within capacitive zone.

Both algorithms separately generate the best set of parameters as well as the best location (Table II) corresponding to the TCSC controller by minimizing the desired objective function  $J$ . The damping ratio of the critical swing mode # 4 with the application of PSO and the GA based TCSC controller in its optimal location has been represented in Table III.

TABLE II  
 TCSC CONTROLLER PARAMETERS AND LOCATIONS

	$K_{tcsc}$	$T_1$	$T_2$	$N_{loc}$
PSO based TCSC parameters and location	16.809	1.00	0.2264	Branch # 16
GA based TCSC Parameters and location	9.986	0.9967	0.1118	Branch # 17

TABLE III  
 APPLICATION OF TCSC CONTROLLER

	with PSO based TCSC		with GA based TCSC	
	Critical swing mode # 4	Damping ratio	Critical swing mode # 4	Damping ratio
Load increased (15 %)	$-1.0611 \pm j5.7341$	0.1819	$-0.9764 \pm j5.7114$	0.1685
Line outage (# 4-13)	$-1.0602 \pm j5.7519$	0.1812	$-0.9247 \pm j5.7731$	0.1581

It is evident from Table III that the damping action of the both PSO and GA based controllers is found to be satisfactory and adequate with respect to the load increase and the outage of the transmission line. The performance of the controller is further demonstrated by computing the angular speed response of the machine #1 relative to the machine # 2. The deviation of angular speed ( $\Delta\omega$ ) response with and without control has been plotted in Fig. 5 for simulation time 7 sec. It has been observed that the damping performance of the PSO based TCSC controller is more effective and satisfactory compared to the GA based TCSC controller for both cases of disturbances.

The convergence rate of the objective function  $J$  towards best solutions with population size 15 and number of generations 200 has been shown in Fig. 6(a) and 6(b). In PSO and GA algorithms, the maximum iteration number 200 is adopted for determining termination condition and to stop the

simulated evolution. The convergence is guaranteed by observing the value of  $J$ , which remains unchanged upto 8 decimal places.

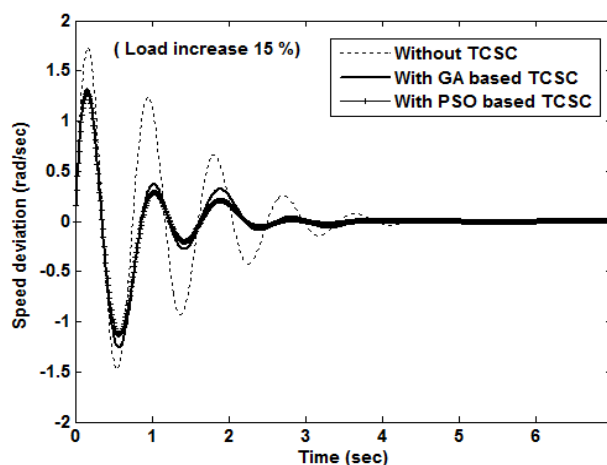

Fig. 5 (a) Speed deviation response of machine #1 for load increase at bus # 9

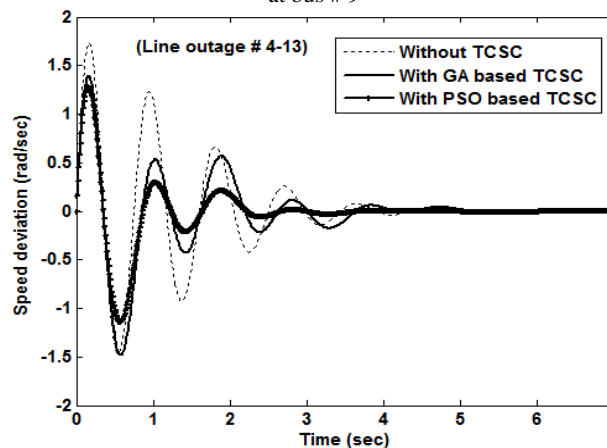

Fig. 5 (b) Speed deviation response of machine #1 for line # 4-13 outage

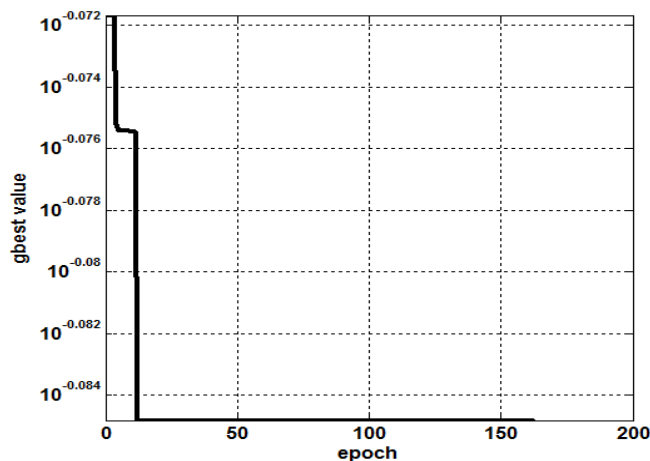

Fig. 6 (a) Convergence of the objective function with PSO

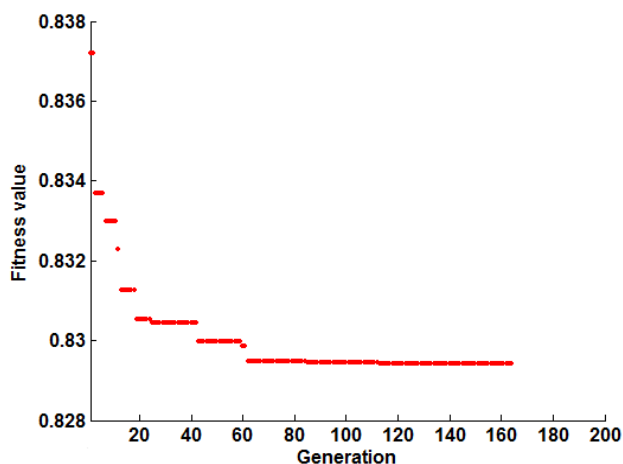

Fig. 6 (b) Convergence of the objective function with GA

### B. Implication of TCSC on Critical Loading

In order to study the performance robustness of the designed TCSC controllers, the effect of critical loading on system stability has been investigated in this section. The real load at bus #9 is increased from its nominal value  $P_L=0.295$  pu,  $Q_L=0.166$  pu in steps. In each case eigenvalues of the system matrix are checked for stability. It has been observed that at load  $P_L=2.60$  pu,  $Q_L=0.166$  pu Hopf bifurcation [19] takes place for the critical swing mode # 4 (Table IV) and led to low-frequency oscillatory instability of the system. When PSO and the GA based TCSC are installed at line #16 and line #17 separately there is no Hopf bifurcation of swing modes (Table V). This implies that the TCSC controllers so obtained by PSO and GA methods can put off the Hopf bifurcation until further increase of load levels.

TABLE IV  
EFFECT OF CRITICAL LOADING WITHOUT TCSC

#	Nominal load a bus # 9 ( $P_L=0.295$ pu, $Q_L=0.166$ pu)		Hopf bifurcation load at bus # 9 ( $P_L=2.60$ pu, $Q_L=0.166$ pu)	
	Swing modes	Damping ratio	Swing modes	Damping ratio
1	-1.6071 ± j7.5211	0.2089	-1.1190 ± j7.7098	0.1436
2	-1.4987 ± j6.5328	0.2236	-1.6357 ± j5.9069	0.2668
3	-1.2074 ± j6.1633	0.1922	-0.9230 ± j2.5144	0.3446
4	-0.9461 ± j5.8552	0.1595	0.0072 ± j4.6175	- 0.0015

TABLE V  
APPLICATION OF TCSC WITH HOPF BIFURCATION LOAD

#	PSO based TCSC in line #16		GA based TCSC in line # 17	
	Swing modes	Damping ratio	Swing modes	Damping ratio
1	-1.1172 ± j7.6664	0.1442	-1.0970 ± j7.6775	0.1414
2	-1.5937 ± j5.7222	0.2683	-1.5572 ± j5.6456	0.2658
3	-3.194 ± j2.4392	0.7947	-2.6778 ± j2.5202	0.7282
4	-1.1218 ± j3.6820	0.2914	-1.0959 ± j3.7960	0.2773

## VI. COMPARISON BETWEEN PSO AND GA

From the simulation results it is evident that both PSO and GA based techniques handle the proposed optimization problem efficiently and generate satisfactory results. But the application of PSO based TCSC controller imparted reasonably more damping to the critical swing mode compared to the GA based TCSC controller (Table VI). It has been found that the GA based TCSC controller improves the damping ratio of the critical swing mode about 12-13% and 6-7% for the case of load increase and transmission line outage respectively, whereas the PSO based TCSC controller improves it more than 20 % against both the cases of disturbances. This implies that PSO based TCSC controller can mitigate the small signal oscillations problem more efficiently than GA based controller.

The convergence rate of the objective function applying PSO has been compared with GA based results (Fig. 6(a) and Fig. 6(b)). It has been observed that in case of PSO based optimization method the objective function,  $J$  has been converged within 15 generations whereas for GA based technique it has taken around 60 generations. Therefore, it appears that PSO has more fast and stable convergence characteristics than GA.

TABLE VI  
COMPARISON BETWEEN PSO AND GA BASED RESULTS

	Damping ratio of critical swing mode # 4		
	Load at bus # 9 (15 % more than nominal)	Line outage (# 4-13)	Critical load at bus # 9
Without TCSC	0.14972	0.1499	- 0.0015
GA based TCSC	0.16852	0.1581	0.2773
PSO based TCSC	0.18196	0.1812	0.2914

## VII. CONCLUSIONS

In this paper a novel stochastic method, PSO has been implemented for optimal parameter setting and identification of optimal site of the TCSC controller in a standard multimachine power system in order to mitigate the small signal oscillation problem. The enhancement of small signal stability has been achieved employing both PSO and GA algorithms by minimizing a desired objective function. The performance of the PSO and the GA based TCSC controller has been compared against power system disturbances e.g. varying load and transmission line outage. The nature of critical eigenvalue and time response analysis reveal that the PSO based TCSC controller is more superior than the GA based TCSC controller even during critical loading. The present approach of PSO based optimization technique appears to have good accuracy, faster convergence rate and is free from computational complexity than GA based technique.

APPENDIX

REFERENCES

A. Proposed Study System

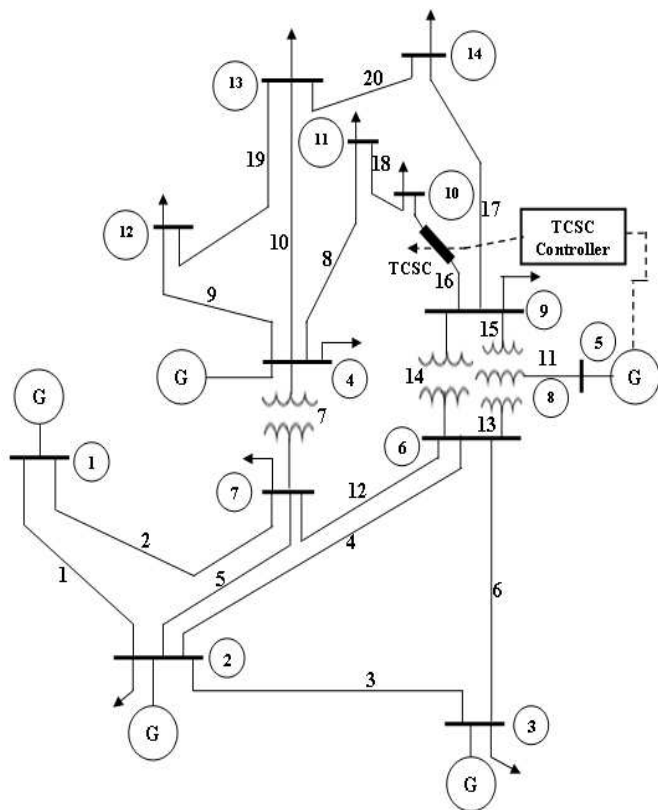

Fig. A.1 IEEE-14 bus system with the application of TCSC

B. Machine and Network State Variables

$$X = [X_1^T \ X_2^T \ \dots \ X_m^T]^T$$

$$X_i = [\delta_i \ \omega_i \ E'_{qi} \ E'_{di} \ E_{fdi} \ V_{Ri} \ R_{Fi} \ V_{si} \ \alpha_i \ X_{TCSCi}]^T$$

$$I_g = [I_{d1} \ I_{q1} \ I_{d2} \ I_{q2} \ \dots \ I_{dm} \ I_{qm}]^T$$

$$V_g = [\theta_1 \ V_1 \ \theta_2 \ V_2 \ \dots \ \theta_m \ V_m]^T$$

$$V_l = [\theta_{m+1} \ V_{m+1} \ \theta_{m+2} \ V_{m+2} \ \dots \ \theta_n \ V_n]^T$$

$$U = [U_1^T \ U_2^T \ \dots \ U_m^T]^T, \ U_i = [I_{Mi} \ V_{refi}]^T \text{ for } i = 1, 2, \dots, m$$

(PV buses) and  $i = m+1, m+2, \dots, n$  (PQ buses).

C. Parameters of TCSC module

TABLE A.I  
PARAMETERS OF TCSC MODULE

Line #	$X_{line}$ (pu)	$X_L$ (pu)	$X_C$ (pu)	$\alpha$ (deg)	$T_{Tcsc}$ (ms)
Branch # 16	0.08450	0.00490	0.02840	150	17
Branch # 17	0.27038	0.00726	0.0726	155	17

[1] P. Kundur, *Power System Stability and Control*. New York: McGraw-Hill, 1994.

[2] E.V. Larsen and D. A. Swann, "Applying power system stabilizer, Part I: General concept, Part II: Performance objective and tuning concept, Part III: Practical considerations," *IEEE Trans on Power Apparatus and Systems*, vol. 100, no. 12, pp. 3017-3046, 1981.

[3] P. Kundur, M. Klein, G. J. Rogers and M. S. Zywno, "Application of power system stabilizers for enhancement of overall system stability," *IEEE Trans on Power Systems*, vol. 4, no. 2, pp. 614-626, 1989.

[4] N.G. Hingorani and L. Gyugyi, *Understanding FACTS: Concepts and technology of Flexible AC Transmission System*. New York, USA: IEEE Press, 2000.

[5] R. K. Pandey and N. K. Singha, "UPFC control parameter identification for effective power oscillation damping," *Int. Journal of Electrical Power and Energy Systems*, vol. 31, no. 6, pp. 269-276, 2009.

[6] M. O. Hassan, Z. A. Zakaria and S.J. Cheng, "Impact of TCSC on enhancing power system stability," in *Proc. APPEEC 2009, IEEE Power and Energy Conference*, pp. 1-6.

[7] A. D. Rosso, C. A. Cañizares and V. M. Doña, "A study of TCSC controller design for power system stability improvement," *IEEE Trans on Power Systems*, vol. 18, no. 4, pp. 1487-1496, 2003.

[8] H. Besharat and S. A. Taher, "Congestion management by determining optimal location of TCSC in deregulated power systems," *Int. Journal of Electrical Power and Energy Systems*, vol. 30, no. 10, pp. 563-568, 2008.

[9] El. MM. Metwally, El. AA. Emery, El. FM. Bendary and M. I. Mosaad, "Optimal allocation of FACTS devices in power system using genetic algorithms," in *Proc. MEPCON 2008, IEEE conference*, pp. 1-4.

[10] C. T. TSE and S. K. TSO, "Refinement of conventional PSS design in multimachine system by modal analysis," *IEEE Trans on Power Systems*, vol. 8, no. 2, pp. 598-605, 1993.

[11] Y. L. Abdel-Magid and M. A. Abido, "Robust tuning of power system stabilizers in multimachine power systems," *IEEE Trans on Power Systems*, vol. 15, no. 2, pp. 735-740, 2000.

[12] S. K. Wang, J. P. Chiou and C.W. Liu, "Parameters tuning of power system stabilizers using improved ant direction hybrid differential evolution," *International Journal of Electrical Power and Energy Systems*, vol 31, no. 1, pp. 34-42, 2009.

[13] H-E. A. Talat, A. Abdennour and A. A. Al-Sulaiman, "Design and experimental investigation of a decentralized GA-optimized neuro-fuzzy power system stabilizer," *International Journal of Electrical Power and Energy Systems*, vol. 32, no. 7, pp. 751-759, 2010.

[14] J. Kennedy and R. Eberhart, "Particle Swarm Optimization," in 1995 *Proc. IEEE International Conference on Neural Networks*, vol. 4, pp. 1942-1948.

[15] S. Panda and N. P. Padhy, "A PSO-based SSSC controller for improvement of transient stability performance," *International Journal of Intelligent Systems and Technologies*, vol. 2, no. 1, pp. 28-35, 2007.

[16] M. A. Abido, A. T. Al-Awami and Y. L. Abdel-Magid, "Analysis and design of UPFC damping stabilizers for power system stability enhancement," *IEEE Inter Symposium on Industrial Electronics*, vol. 3, pp. 2040-2045, 2006.

[17] S. Panda, N. P. Padhy and R. N. Patel, "Modelling, simulation and optimal tuning of TCSC controller," *International Journal Simulation model*, vol. 6, no. 1, pp. 37-48, 2007.

[18] C. R. Fuerte-Esquivel, E. Acha and H. Ambriz-Pe'rez, "A thyristor controlled series compensator model for the power flow solution of practical power networks," *IEEE Trans on power systems*, vol. 15, no. 1, pp. 58-64, 2000.

[19] P. W. Sauer and M. A. Pai, *Power system dynamics and stability*, Singapore: Pearson Education Pte Ltd, 1998.

[20] B. Birge, "Particle Swarm Optimization Toolbox," Available at [www.mathworks.com/matlabcentral](http://www.mathworks.com/matlabcentral).

[21] D. Goldberg, *Genetic algorithms in search, optimization and machine learning*, Addison-Wesley, 1989.

[22] S. K. M. Kodsí and C. A. Canizares, *Modeling and simulation of IEEE 14 Bus systems with FACTS controllers*, Technical Report #2003-3, University of Waterloo, pp. 1-46, 2003. Available at <http://www.uwaterloo.ca>.

**D. Mondal** received his degree of engineering and Master of Engineering in 1998 and 2000, respectively. He has total 11 years of industrial and teaching experience. He holds a permanent post of Assistant Professor at the Haldia Institute of Technology, India. His research interests on the areas like power systems stability, soft computing and robust control. Mr. Mondal is a Member of Institution of Engineers (India) (IEI)

**A. Chakrabarti** received B.E., M.Tech. and Ph.D. (Tech) degrees in 1978, 1987 and 1991 respectively. He is a professor at the Department of Electrical engineering, Bengal Engineering and Science University, India. He has 30 years of research and teaching experience and has around 120 research papers in National and International journal and conferences. He has active interest on the areas like power systems, power electronics and circuit theory. Prof. Chakrabarti is a Fellow of Institution of Engineers (India) (IEI).

**A. Sengupta** received her B.E., M.Tech. and Ph.D. degrees in 1992, 1994 and 1997, respectively. She is employed in teaching and research at the Department of Electrical engineering, Bengal Engineering and Science University, India, for 14 years. Her areas of interest are power system, robust control and nonlinear control and estimation methods.