

An Intelligent Cascaded Fuzzy Logic Based Controller for Controlling the Room Temperature in Hydronic Heating System

Vikram Jeganathan, A. V. Sai Balasubramanian, N. Ravi Shankar, S. Subbaraman, and R. Rengaraj

Abstract—Heating systems are a necessity for regions which brace extreme cold weather throughout the year. To maintain a comfortable temperature inside a given place, heating systems making use of 'Hydronic boilers' are used. The principle of a single pipe system serves as a base for their working. It is mandatory for these heating systems to control the room temperature, thus maintaining a warm environment. In this paper, the concept of regulation of the room temperature over a wide range is established by using an Adaptive Fuzzy Controller (AFC). This fuzzy controller automatically detects the changes in the outside temperatures and correspondingly maintains the inside temperature to a palatial value. Two separate AFC's are put to use to carry out this function: one to determine the quantity of heat needed to reach the prospective temperature required and to set the desired temperature; the other to control the position of the valve, which is directly proportional to the error between the present room temperature and the user desired temperature. The fuzzy logic controls the position of the valve as per the requirement of the heat. The amount by which the valve opens or closes is controlled by 5 knob positions, which vary from minimum to maximum, thereby regulating the amount of heat flowing through the valve. For the given test system data, different de-fuzzifier methods have been implemented and the results are compared. In order to validate the effectiveness of the proposed approach, a fuzzy controller has been designed by obtaining a test data from a real time system. The simulations are performed in MATLAB and are verified with standard system data. The proposed approach can be implemented for real time applications.

Keywords—Adaptive fuzzy controller, Hydronic heating system.

I. INTRODUCTION

HEATING systems have become inevitable in almost all the colder parts of the world, today. They have become as much a part and parcel of life as air conditioners in the hotter regions. They employ HYDRONIC boilers, which is the primary component of these heating systems. It is governed by the principle of a single pipe system. Steam is delivered to various radiators, where it gives up its heat and is condensed back to water. The hydronic heating system consists of a boiler that provides central heating water to a single radiator or multiple radiators. The room temperature is regulated systematically by a motor, which drives a variable position valve assigned for each radiator. These valves are assigned to control the flow of hot water through each radiator. The extent

of heat for producing the steam depends upon the room temperature required. For well oriented operation, these systems are completely dependent on the proper functioning of thermally-closed air venting valves located on radiators throughout the area to be heated. When not in use, the Hydronic system's valves are open to the atmosphere, in which case, the steam pipes and radiators contain regular air. When heat is called for by the thermostat, the boiler starts, and produces steam from the water contained in the boiler. This steam expands gradually and rises, and displaces the air contained in the steam pipes. The displaced air rapidly exits from the air venting valves located on the radiators, and, in the case of larger systems, valves placed on the steam pipes themselves. When the steam reaches each air venting valve located on each radiator, a small quantity of solvent (usually alcohol) contained within the valve is heated by the steam, and rapidly turns into vapour, exerting a copious amount of mechanical force to close the valve, thereby holding the steam inside the radiator, and preventing it from exiting the radiator into the room being heated. After the heating cycle is over, the boiler shuts down automatically, and the steam in the radiators cools down. Once the air venting valve is sufficiently cool, the solvent located within each radiator valve will be liquefied again, and the valves on each radiator would be exposed to the atmosphere. This function allows air to enter the steam pipes, and the steam and water contained within, to drain back down to the boiler. This is a repetitive cycle, carrying on perennially, maintaining the required room temperature. The Hydronics boiler boasts of many merits: They are far more superior and realistically economic than the forced air systems. They provide more even, less fluctuating temperatures than forced-air systems, which accounts to better stability; and most importantly, they don't spew out any harmful combustion by-products and allergens to the atmosphere. As a system buoyed by all these advantages, it has become the most used modern heating system. This paper astutely provides an extension to the AFC employed earlier, making use of the Adaptive Fuzzy Controllers (AFC), to regulate the temperature in the system. The AFC in providence automatically learns the steady-state radiator valve positions for five operating set points and uses this information in a fuzzy controller that commands the radiator valve position. The system makes use of a temperature sensor to sense the room temperature. In accordance to the sensed temperature, a battery operated actuator controls the valve position. The control of this valve

Authors are with Department of Electrical and Electronics Engineering, S. N. College of Engineering, India (e-mails: jvikramin@gmail.com, avsaibala@gmail.com, shankyingill@gmail.com, kumar.subba@gmail.com, rengaraj2@rediffmail.com).

culminates in the regulation of the room temperature. This is the basic operating procedure of the hydronics heating system. The proposed system has two AFC devices: one, a single input, and two output devices. The input is the outside temperature sensed by a temperature sensor. The fuzzy controller, after processing this input, yields two outputs: one a preset value of the desired user temperature for the present outside temperature, and the other, which is the amount of heat energy to be supplied to the boiler to achieve the required temperature. This calculated amount of heat is given to the boiler, which heats up the water, producing steam. This is then directed towards the various radiators present. A comparator is employed to find the error between the present room temperature and the user desired temperature. This is given as an input to the other AFC. The fundamental function of this device is to determine the amount by which the valve has to be opened, which directly controls the quantity of hot steam flowing through the radiators. If the error is very high, the knob position is set to 5 (max). On the contrary, if the error is meager, the knob position is set to the minimum value. The knob position varies from the minimum and the maximum values for the intermediate values of error.

In [1], an innovative adaptive fuzzy control (AFC) algorithm for regulating the room temperature in a hydronic heating system is proposed. Room temperature is regulated with a motor that drives a variable-position valve on each radiator that controls the flow of hot water through the radiator. The AFC automatically learns the steady-state radiator valve positions for five operating set points and uses this information in a fuzzy controller that commands the radiator valve position. The most important objective of this paper is to implement the AFC controller to overcome the defects in the conventional PI controller.

In [3], an orderly design procedure that can save time and help prevent problems in the development of fuzzy logic systems is presented. The nature of fuzzy logic is examined, and the design of fuzzy control systems is discussed. The architecture of a simple fuzzy controller for a steam turbine is used as an example, to show how fuzzy control models work. A four-step methodology for fuzzy system design is described.

The literature reports in [9] illustrate a method for tuning fuzzy feedback controllers using the circle criterion. The method can be used for design, tuning at commissioning, or online adaptation of systems consisting of a fuzzy feedback. The concepts of gain and phase margin are used. It is illustrated using a fuzzy proportional feedback controller with feedforward compensation. It is concluded that the key tuning parameter for stability is the ratio of the universe of discourse

for the error input and the universe of discourse for the control output

The literature reports in [10] propose a fuzzy controller to control the brake rate of the automobiles. The speed of the vehicle in which the brake is to be applied and distance of the vehicle from the point at which it has to stop are passed as input parameters to a fuzzifier. The controller compares these inputs with the rule base and gives the desired output.

In [11] a fuzzy logic based controller which dynamically adjusts the quality of the picture by adjusting the values of brightness and contrast with respect to the sensor values has been proposed.

II. FUZZY CONTROLLER AND ITS MEMBERSHIP FUNCTIONS

Fuzzy controller consists of a classifier, fuzzifier, rule base, interface engine. In the fuzzy rule base, various rules are formed according to the problem's requirements. The numerical input values to the fuzzier are converted into fuzzy values. The fuzzy values along with the rule base are fed into the inference engine which produces control values. As the control values are not in usable form, they have to be converted to numerical output values using the defuzzifier. The block diagrams of the fuzzy controllers used in this paper is shown in Fig. 1.

There are two fuzzy controllers present in this paper. One AFC is a single input, two output device. The second one is a single input, single output device. The first AFC is described as follows:

The single input parameter considered in this controller is the outside temperature. This measures the temperature outside the room which is to be heated. The outside temperature is divided into five membership functions- very cold, cold, mild, hot, and very hot. Very cold condition corresponds to a freezing condition. This can be mostly expected during the winter season of most countries. The next category is cold, which is a chilly condition mostly encountered in hilly regions throughout the year. The mild function relates to the condition when the climate is very pleasant. This usually occurs during the spring season. The hot function represents the situation where the sun's rays have increased intensity and cause perspiration. This is prevalent in summer. The very hot function corresponds to the time when the intensity of the sun's rays is searing. This situation is encountered during the peak of the summer season, especially in equatorial areas. The membership functions of the input parameter are shown in Fig. 2.

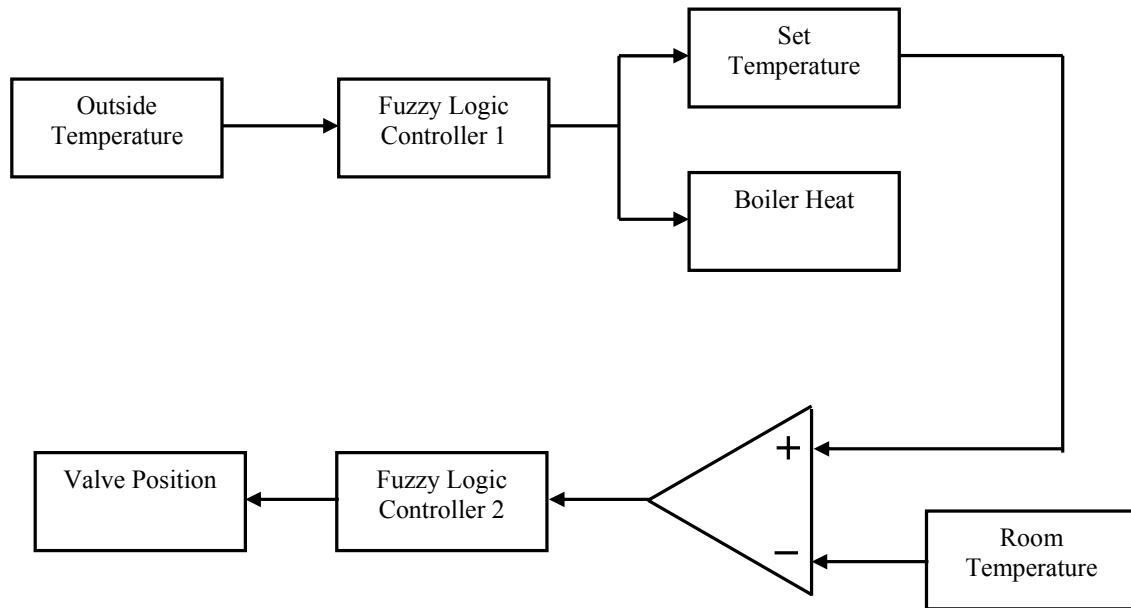

Fig. 1 Block diagram of fuzzy controller for the regulation of room temperature

There are two output parameters- Set temperature and Boiler heat. The set temperature corresponds to the user desired temperature inside the room. This is divided into 3 categories: chill, pleasant & warm. Chill is the temperature set by the user to have a relatively cooler environment than the outside. Pleasant is the condition wherein the inside temperature is not too chill & not too warm. This is considered as a comfortable temperature range. Warm is a temperature range where the room is heated, to be at a slightly more temperature than the outside. The second output parameter is the Boiler heat. It gives the amount of heat that is to be supplied to the boiler to bring out the required temperature. It is set to three discrete values, which varies according to the size and capacity of the hydronic boiler used. The membership functions of the two output parameters are shown in Fig. 3 & Fig. 4 respectively. The membership functions, outside temperature and Set temperature are triangular, whereas Boiler heat function is discrete.

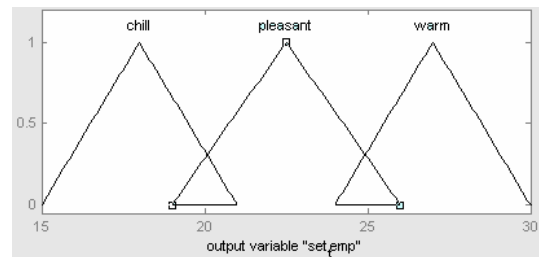

Fig. 3 Membership functions of set temperature

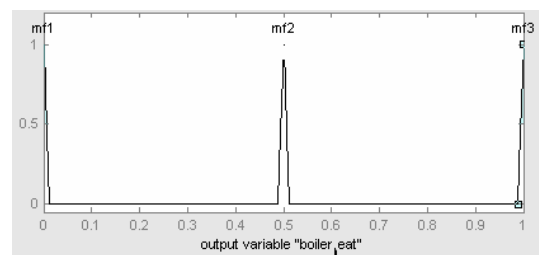

Fig. 4 Membership functions of Boiler heat

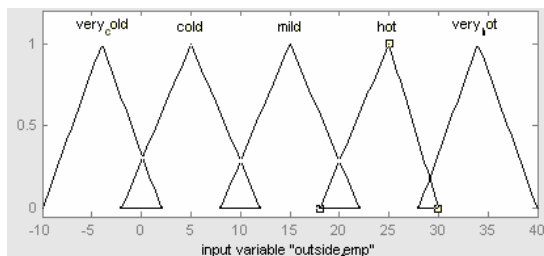

Fig. 2 Membership functions of outside temperature

It consists of a single input parameter – Error. The error is obtained by comparing two parameters: Room temperature and Set temperature. The error is divided into five membership functions. They are very low, low, medium, high, and very high. This value is compared with the rule base and the output i.e. the valve position is generated. This relates to the amount by which the valve must be open to allow in the proportional amount of heat required. This is categorized into five sub-functions: close, partially open, half open, almost open, fully open. These valve positions determine the quantity of heat flowing through the radiator pipes, thereby having a direct effect on the temperature to be set. The membership function, Set temperature is triangular. The output

membership function, Valve position is discrete. The membership functions of 'error' parameter and 'valve position' parameter are shown graphically in Figs. 5 and 6 respectively.

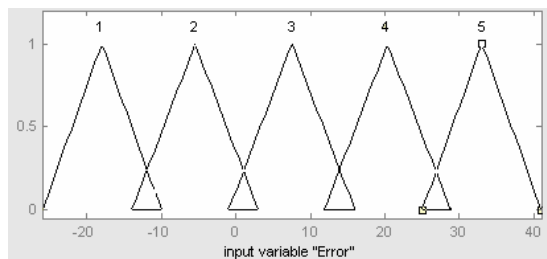

Fig. 5 Membership functions of Error between set temperature and room temperature

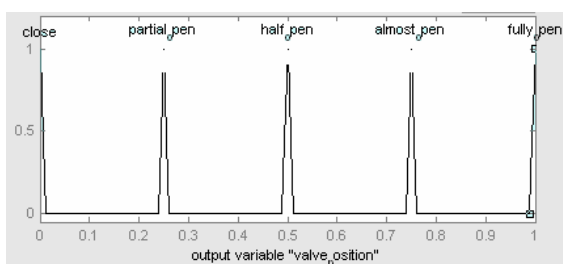

Fig. 6 Membership functions of valve position

III. IMPLEMENTATION OF FUZZY CONTROLLER

There are two AFC systems considered in this paper. In the first AFC, a single factor is taken into account- outside temperature. This measures the temperature condition outside the target room to be heated. The measurement of this parameter is carried out by means of a temperature sensor placed outside the room. This parameter is then passed on to the fuzzy controller. The fuzzifier classifies the input based on their values in one of the types. Next, the fuzzifier compares it with the rule base and the required boiler heat and the set temperature appear as outputs of the fuzzy controller. This set temperature is given as one of the inputs to the comparator. The other input is the room temperature. It measures the present temperature inside the room by using a suitable temperature sensor inside the room. The comparator finds the error between these two parameters and inputs it to the fuzzy controller. The AFC, according to the rule base, renders the output, which is the position of the valve to be set for the desired amount of heating. This Valve position parameter determines the quantity of heat to be supplied to the room, thus regulating the inside temperature. This variable position valve is systematically controlled by a motor. Thus the error is continuously monitored and the room temperature is varied accordingly.

There are a total of only 5+5=10 rules. This reduces the processing time thereby increasing the systems efficiency. Let us consider one example in each AFC controller.

- ✓ If the **outside temperature** is **cold** then the output **set temperature** is **warm** and the **boiler heat** is **mp3**.
- ✓ If the **error** is **1** the **valve position** is **partial open**.

IV. RESULTS AND DISCUSSION

The idea of conceiving a Fuzzy logic controller to regulate temperature has been done earlier. This paper merely enhances the control and function by a significant amount when compared with the earlier papers. In the previous papers, Adaptive Fuzzy Logic controllers came as replacements for the previously existing PI controllers. The merits of the AFC can be observed as follows:

- ✓ Laboratory tests conducted under typical operating conditions show that the AFC simultaneously improves the control quality while reducing the battery consumption when compared with a conventional proportional integral (PI) feedback controller.
- ✓ The AFC has improved control quality, spending 23% more time within 0.5°C of the set point and 32% more time within 0.25°C of the set point, which has been found out in a 70-hour laboratory test conducted with typical operating set points, under standard conditions.
- ✓ In the same experiment, it was discovered that the estimated battery use for the AFC is 36% less than that for the PI.
- ✓ The AFC's memory and processing requirements are suitable for embedded microprocessors; so it is a realistic replacement for a conventional PID algorithm.
- ✓ It brings about tighter control about the set point.
- ✓ Reduces the actuator movement, and adapts better to different rooms.
- ✓ The AFC overshoots less than the PI when the set point increases from 16° to 20°C. This contributes to the reduced energy consumption for the AFC, which is 7% less than for the PI.
- ✓ The speed of response is the same for the AFC and PI algorithms at the 22°C set point despite the fact that the AFC valve position is 70% or less when the PI maximum valve position is 100%.
- ✓ Limiting the maximum valve position reduces the estimated battery consumption for the AFC.
- ✓ The AFC has smaller oscillations about the 16°C set point at steady state. This contributes to both improved control quality and reduced battery consumption.

The realization of the proposed system is completely validated by the test data furnished above. The basic concept and constructional features of the AFC are retained in this paper. In essence, this paper acts as an upgradation to the

conventional AFC, introducing new features for better control and operation. The earlier system could control temperatures only over a short range. On contrast, the proposed system can regulate temperatures over a wide range. This range is limited by the heating capacity of the boiler. Triangular shaped membership function is chosen for all the variables. This is the simplest form of membership function and this makes the design simple. Also different defuzzification methods are employed and the centroidal method is found to suit the problem in a better manner compared to other defuzzification methods. This is shown by the following figures. Fig. 7 shows the graph with defuzzified values found using centroidal method and Fig. 8 shows the graph employing mom and lom methods.

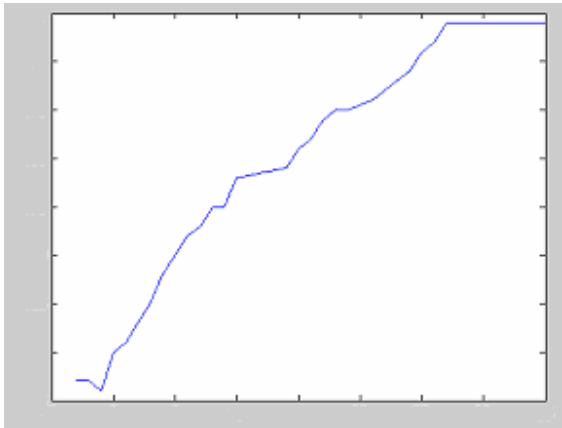

Fig. 7 Graph showing defuzzified values using centroidal method

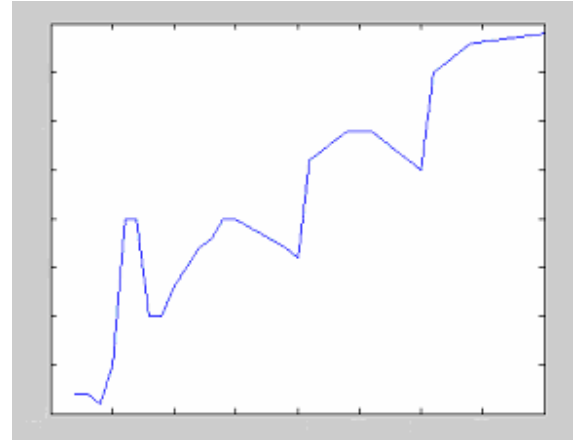

Fig. 8 Graph showing defuzzified values using lom,mom methods

REFERENCES

- [1] Dr. Christine Haissig, Adaptive Fuzzy Temperature Control for Hydronic Heating Systems, Proceedings of the 1999 IEEE International Conference on Control Applications Kohala Coast-Island of Hawai'i, Hawai'i, USA August 22-27, 1999.
- [2] K. Astrlm and T. Hagglund, *PID Controllers Theory, Design, and Tuning*, Research Triangle Park, NC: Instrument Society of America, 1995.
- [3] E. Cox, "Fuzzy fundamentals," *IEEE Spectrum* (October), pp. 58-61, 1992.
- [4] C. Lee, "Fuzzy logic in control systems: Fuzzy logic controller, part I," *IEEE Trans. on Systems, Man, and Cybernetics*, vol. 20, no. 2, pp. 404-418, 1990.
- [5] C. Lee, "Fuzzy logic in control systems: Fuzzy logic controller; part 11," *ZEEE Trans. on Systems, Man, and Cybernetics*, vol. 20, no. 2, pp. 419-435, 1990.
- [6] E. Cox, "Adaptive fuzzy systems," *IEEE Spectrum* (February), pp. 27-31, 1993.
- [7] L. Wang, *Adaptive Fuzzy Systems and Control: Design and Stability Analysis*, Englewood Cliffs, NJ: Prentice Hall, 1994. "Adaptive fuzzy logic controller that modifies membership functions," U.S. Patent No. 5,822,740.
- [8] C. Haissig, M. Woessner, and D. Pirovolou, (October 13, 1998). European, Canadian, and Japanese patents pending, 1998.
- [9] C. Haissig, "Tuning fuzzy feedback controllers using the circle criterion," 1996 IEEE Conference on Control Applications, Dearborn, MI, September 1996.
- [10] Nikunja K. Swain, "A Survey of Application of Fuzzy Logic in Intelligent Transportation Systems (ITS) and Rural ITS"- Southeast Con, Proceedings of IEEE, 2006, pp 85-89.
- [11] Dalal, S.; Satyanarayana, S. "Application of fuzzy logic to picture quality improvement in televisions", Digest of Technical Papers. ICCE., IEEE 1993 International Conference on Volume, Issue, 8-10 Jun 1993 Page(s):346 - 347.