

Reliability Analysis of Tubular Joints of Offshore Platforms in Malaysia

Nelson J. Cossa, Narayanan S. Potty, Mohd Shahir Liew, Arazi B. Idrus

Abstract—The oil and gas industry has moved towards Load and Resistance Factor Design through API RP2A - LRFD and the recently published international standard, ISO-19902, for design of fixed steel offshore structures. The ISO 19902 is intended to provide a harmonized design practice that offers a balanced structural fitness for the purpose, economy and safety. As part of an ongoing work, the reliability analysis of tubular joints of the jacket structure has been carried out to calibrate the load and resistance factors for the design of offshore platforms in Malaysia, as proposed in the ISO. Probabilistic models have been established for the load effects (wave, wind and current) and the tubular joints strengths. In this study the First Order Reliability Method (FORM), coded in MATLAB Software has been employed to evaluate the reliability index of the typical joints, designed using API RP2A - WSD and ISO 19902.

Keywords— FORM, Reliability Analysis, Tubular Joints

I. INTRODUCTION

TRADITIONALLY, offshore jacket structures in Malaysia have been designed using API Working Stress Design (API RP2A - WSD). This code applies a single safety factor for all the load and resistance uncertainties. The ISO 19902 approach uses partial load and resistance factors for different load categories and for different resistance components. In order to adapt the ISO approach for Malaysia, it is necessary to undertake a detailed calibration study [1]. The fundamental theory of reliability analysis in structural design has been presented by Nowak and Collins [2] and ISO2394 [3], in which the requirement of the load and resistance statistical studies is highlighted. In line with the development of the ISO 19902[4] standards for design of fixed steel structures, Bomel Ltd. has carried out studies for the structural reliability calibration, which covered the North Sea conditions requirements [5]. The Bomel Ltd provides an overview of the reliability theory as applied in the calibration of load and resistance factors, for existing structures. Similar studies were conducted for the China Bohai Sea [6][7]. This paper focuses on the work undertaken in the context of the Malaysia Offshore Waters and presents the procedures adopted for the

reliability analysis, in which the definition of the limit state function is based on Bomel Ltd.

II. ENVIRONMENTAL PARAMETERS

The uncertainty of load effect on the tubular joints of jacket platforms can be traced to the variability of the environmental parameters. This section discusses the stochastic process of the environmental parameters. The combined effect of wind and wave load effect on the offshore structures has been subject to intensive research. For instance, a storm event, in non-sheltered seas of sufficient fetch the long term characteristics of wind and wave are highly correlated. Meanwhile, the buildup waves of due to wind takes a considerable time, the short-term (scale of hours) fluctuations of wind and current are considered statistically independent[8]. Traditionally, in offshore engineering the short term fluctuations are considered with reference to the following periods 10-minutes for wind and 3-hours for wave. And the characteristic values are defined as the maximum load effect generated by a 50 or 100 year return period for 10-minute storm peak wind climate; and 3-hours storm peak significant wave height climate, peak period and associated spectrum [8].

Generally, the wave height is distributed jointly with the wave period, nevertheless the examination of global loads demonstrated that the effect of wave height was independent from the wave period. The metocean data collected from several points within the areas of interest is generally presented in form of scatter diagrams and analyzed statistically [9].

The prediction of the significant wave height is made using the both regression and method of moment, and the fitting to the three parameters *Weibull* and the *Fisher-Tippet* types I, II, and III distributions [10] [11] [12]. Various researchers have demonstrated that, most distributions of the environmental parameter agreed with either with the *Weibull* and *Fisher-Tippet Type I (Gumbel)* distributions. Adopting the *Weibull* distribution to model the statistical uncertainties and the effects of the parameter fitting procedure for wave height and wave period, takes the following form:

$$F_X(x) = 1 - \exp \left[- \left(\frac{x-a}{b} \right)^c \right] \quad (1)$$

This can be manipulated to give the following linear expression:

$$\ln\{-\ln[1 - F_X(x)]\} = c \ln(x - a) - c \ln(b) \quad (2)$$

It is obvious that a plot of $\ln\{-\ln[1 - F_X(x)]\}$ against $\ln(x - a)$ will be a linear function. The linear regression is

Cossa, N. J., is MSc. student at Civil Engineering department in Universiti Teknologi Petronas, Tronoh, 31750, Perak, Malaysia; (e-mail: njcossa@gmail.com)

Potty, N. S., is with the Universiti Teknologi Petronas, Tronoh, 31750, Perak, Malaysia (e-mail: narayanan_sambu@petronas.com.my).

Liew, M. S., is with the Universiti Teknologi Petronas, Tronoh, 31750, Perak, Malaysia (e-mail: shahir_liew@petronas.com.my).

Arazi B Idrus is with Universiti Teknologi Petronas, Tronoh, 31750, Perak Malaysia (e-mail: arazi_idrus@petronas.com.my)

performed to determine the values of parameters a , b , and c , Assuming two parameter Weibull distribution, the parameter a is reduced to zero ($a=0$). For a particular distribution, the expected significant wave height, for a selected return period can be estimated as follows:

$$T_{mean} = aH_s^c \quad (3)$$

The metocean data used in this study was obtained from design reports which contained the design values of wave height, wave period, current speed and wind speed, for 1 – year, 10 – years, 50 – years and 100 – years return periods. And using its cumulative distribution equation and given two extreme values with return periods of 10 and 100 years the probability of exceedence per year is 0.1 and 0.01 respectively. The two unknown parameters of the distribution can be easily calculated analytically using Equation 2. And the results are displayed in *Table I*. Note these values were fitted to annual extreme events

TABLE I
WEIBULL 2 – PARAMETER DISTRIBUTION FOR SIGNIFICANT WAVE HEIGHT,
WIND AND CURRENT SPEED

Parameter	Scale	Shape	Mean	St. Dev
Signif. Wave Height (m)	2.92	2.64	2.59	1.06
Wind speed (m/s)	20.91	4.67	19.12	4.67
Current speed (m/s)	0.86	7.73	0.81	0.12

And the joint distribution of significant wave height and wave period is simplified into a power relationship (Figure 1) which was found to be:

$$T_p = 5.001H_s^{0.4778} \quad (4)$$

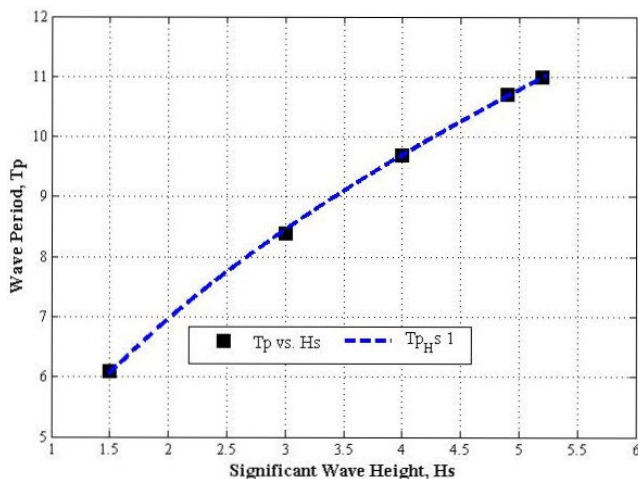

Fig. 1 Significant Wave Height vs. Wave Period

III. ENVIRONMENTAL LOAD MODELING

Given that the offshore structures are installed in fluid environment, the load effect is evaluated using hydrodynamic concepts. The metocean parameters provide an idea that the structures are under the influence of steady and variable wave, current and wind action. The submerged part of the structure is subject to currents and wave forces. The current forces tend to be steady in nature, and their effect varies with the water

depth. On the other hand, the wave forces are unsteady and exert the largest loading on the structures. The winds exert predominantly steady forces on the exposed parts of offshore structures, they account to not more than 10% of the total hydrodynamic loads on the structure [13] [14].

Morison's Equations are applied to evaluate the effect of hydrodynamic loads on the offshore structures [15]. The effect of these loads on the structural element depends on both the ocean (wave and current) and structural parameters. Therefore the structural response surface method is applied to predict the loads on structural member, for given space of environmental parameters (basic random variable). The SACS Software, for structural analysis of the jacket platform, was used to compute the loads on each structural element under a given metocean input. The load response of the structural element can then be expressed as function of the environmental parameter as follows:

$$W = f(\text{Wave, Current and Wind}) \quad (5)$$

Note that metocean parameter consists of the stochastic parameters evaluated on the previous section. However due to its low contribution on the total load, the wind loads is considered to be deterministic. The wave period, which is also an input variable into the SACS, is incorporated on the wave height effect, since they are jointly distributed. Hence the response function is based on the current and wave parameters and the following model would be used:

$$W = a + bH_{Max}^2 + cH_{Max} + dV_c^2 + eV_c \quad (6)$$

For drag dominated structures, the hydrodynamic response model is quadratic, given that the wave height is raised to power 2[8]. The coefficients a , b , c , d , e , depend on the structural element location and these values could be different for each element.

Alternatively, as adopted in this paper, 50 – sets of random values of wave height, wave period and current speed were set as input, and the respective load output, W were recorded. The values of W were fitted to theoretical distributions. The *Kolmogorov-Smirnov* (K-S) test and the *Mean Square Method* were used to measure the *Goodness of Fit* of the distributions. Figure 2 to Figure 4 illustrate the fitted distributions to determine the effect of the environmental load on a joint's brace. The statistical properties are summarized in *Table II*.

TABLE II
ENVIRONMENTAL LOAD (W) PARAMETER DISTRIBUTIONS

Joints Type	Load Type	Distrib.	Mean	St. Dev
T/Y	Axial	LogNorm	0.913	0.175
	IPB	Weibull	0.716	0.357
	OPB	LogNorm	0.889	0.184
K	Axial	Frechet*	0.836	0.248
	IPB	Weibull	0.755	0.351
	OPB	LogNorm	0.931	0.093
X	Axial	Weibull	0.781	0.281
	IPB	LogNorm	0.966	0.045
	OPB	LogNorm	0.770	0.352

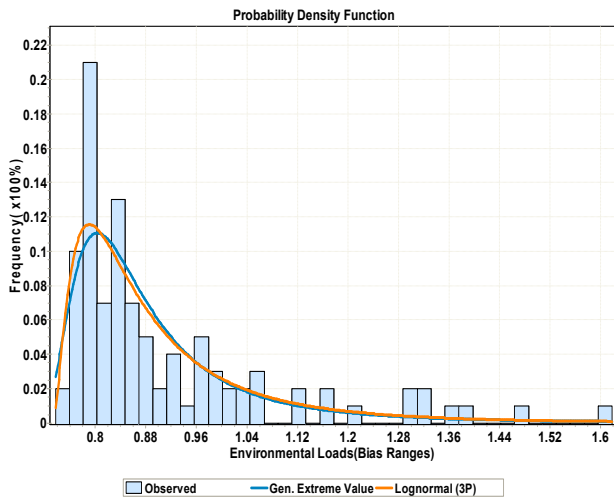

Fig. 2 T/Y-Joint – Axial Load on Brace

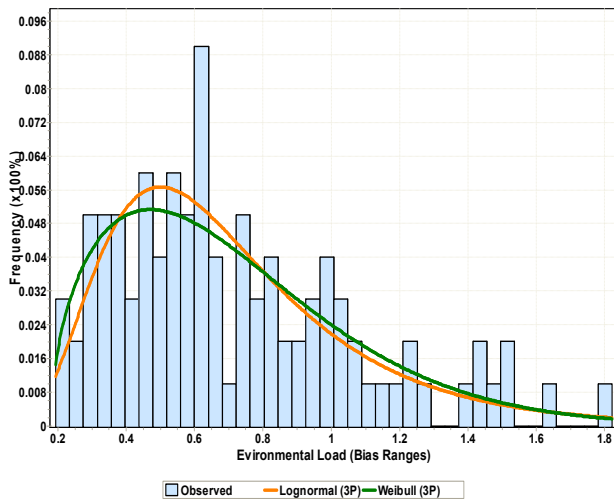

Fig. 3 T/Y-Joint – In-Plane Load on Brace

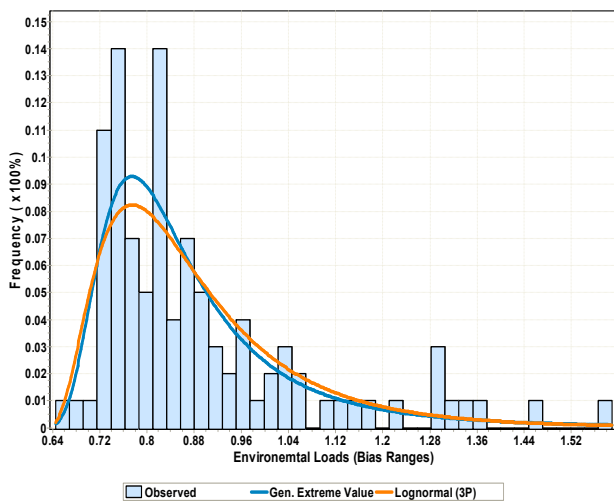

Fig. 4 T/Y-Joint – Out of Plane Load on Brace

IV. GRAVITY LOAD MODELING

The probabilistic description of gravity loads was based on North Sea data. For dead loads, D , a bias of 1.0 and a COV of 0.06 were used. The same bias but with a COV of 0.10 was adopted for live loads, L [5].

V. LOAD UNCERTAINTY MODEL

The total load acting on the structural element consists of all gravity loads and environmental loads. Typically in the reliability analysis, engineers would be looking for a load that causes the structural element to fail. One way is to apply the push-over analysis, in which the structural model is loaded until it achieves the ultimate capacity and it fails. This method is useful for obtaining the overall system reliability index. On the other hand, if the aim is to evaluate the component reliability index, the push-over analysis method is not applicable. Because, it is almost impossible to evaluate the exact value of the applied load, at which a particular the structural component fails. Therefore, the evaluation of loading term in the limit state function follows the Equation 7 [5]:

$$Q = (dD + lL + W/X_w)R_{des} \quad (7)$$

In which: R_{des} - is the design resistance (or maximum load to give a utilization of unity) for the nominal component to the appropriate code, and is a function of the load and resistance partial factors (or safety factors in WSD), the nominal geometric and material parameters.

d, l and w - are the proportions of unfactored dead, live and environmental loads. And are based on the actual loads acting on the structural element for the given design value. These are obtained from SACS analysis output report. Note that $d + l + w = 1.0$

D, L and W - are the random variables for the uncertainty in dead, live and environmental loading.

X_w - is the model uncertainty associated with W .

The above equation ensures that the loading term represent the factored load to a particular design code, in which its uncertainty is determined by $(dD + lL + wW/X_w)$. It also allows a direct comparison of the failure probabilities for different design codes.

VI. RESISTANCE UNCERTAINTY MODEL

The resistance uncertainty, of the components is evaluated using the ISO 19902 formulations without the safety factors, because these provide the best model, and based on the recent research studies. The exclusion of the safety factors, aims to capture the basic/ actual resistance strength of the components. The model is a function of the uncertainties of the basic variables (geometric and material parameters) and the model uncertainty (X_m) associated with the particular ISO formulation.

$$R = f(D, T, F_y, E, X_m, \dots etc) \quad (8)$$

The basic random variables for resistance were determined in author's previous publications [1] [5].

A. Mode of Failures

In estimating the reliability offshore jacket platform it is important to include the different types and failure modes of the tubular joints. The limit state function is defined uniquely for each condition. Tubular joints are mainly classified into 3 types, namely K-, T/Y- and X-Joints, and the typical modes of failure are:

- Yielding
- Punching
- Buckling
- Fatigue.

In this study, only the Static Yielding Strength of the joints is considered for the reliability analysis. Figure 5 shows the parameters of a typical tubular joint.

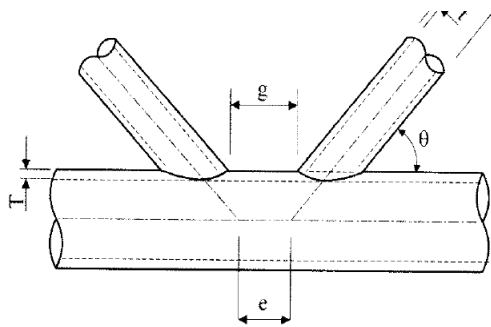

$$\beta = \frac{d}{D} \quad \gamma = \frac{D}{2T}$$

Fig. 5 Typical Tubular Joint

The strengths for simple tubular joints subjected to axial brace forces or moments only should be calculated for each brace, for each individual force component of tension, compression, in-plane bending and out-of plane bending, and for each load case consisting of a combination of forces. Representative strengths for simple tubular joints are given in [4]:

$$Pd = \frac{F_y \cdot T^2}{\sin \theta} \cdot Q_u \cdot Q_f \quad (9)$$

$$Md = \frac{F_y \cdot T^2 \cdot d}{\sin \theta} \cdot Q_u \cdot Q_f \quad (10)$$

The basic strength joint parameter (Q_u) is dependent on the type of load and joint classification, and is expressed in terms of factors β and γ . The chord load factor (Q_f), accounts for the effect of nominal loads on the chord, therefore is considered for parametric studies. Nevertheless, in this paper Q_f is assumed to be equal to 1.

VII. TARGET RELIABILITY ANALYSIS

A. Concept and Limit State Function

Reliability analysis is used to estimate the probability that the design criteria are not met (fail), by taking into account the parameters variability (e.g. geometric/material properties), and by defining suitable design criteria on critical performance quantities [16].

The probability of failure (P_f) is calculated based on the reliability index, β using $P_f = \Phi(-\beta)$. The relationship $\Phi(\cdot)$ is the standard normal distribution function (zero mean and unit variance). Basic reliability analysis evaluates the structural failure by determining whether the limit state function, also known as performance function, is exceeded. The performance function indicates the margin of safety between resistance and the load of structures and is defined as [17] [18]:

$$g(R, Q) = R - Q \quad (11)$$

1. Performance function for API RP2A- WSD 21st Edition:

$$g(R, Q) = Pd_i \cdot X_m - [(dD + lL + wW) \cdot Pd/FS] \quad (12)$$

2. Performance function for ISO 19902 1st Edition:

$$g(R, Q) = Pd_i \cdot X_m - [(dD + lL + wW) \cdot Pd/FoS] \quad (13)$$

$$FoS = (D + L + W) / [\gamma_R \cdot (\gamma_D \cdot D + \gamma_L \cdot L + \gamma_W \cdot W)] \quad (14)$$

For the above equation, structural safety is reached when $R = Q$, and failure will occur when $g(R, Q) < 0$. The reliability index, β , can be simply determined as ratio of performance function mean value to standard deviation:

$$\beta = \mu_g / \sigma_g \quad (15)$$

There are number of accurate approaches used for the finding out the reliability index of structural components, however the commonly used is the First Order Reliability Method (FORM). This method is a gradient-based search algorithm to locate the nearest point in the parameter space that yields a failure. In this point, also called design point, a linear approximation of the Limit State Function (LSF) is used as an approximate boundary between the safe and failure domain [19]. The iterative Hasofer-Lind, Rackwitz-Fiessler (HL-RF) algorithm is applied to find the design point [18]. The MATLAB Code, to evaluate the reliability index, and the respective design points.

B. Reliability Index Evaluation

The reliability index evaluation of typical joints was based on the input that has already been defined. For each type of joints a range of calibrations points were defined and applied to investigate the effect of different load effects and partial factors parameter. For instance, the results presented in this paper were evaluated to study the effect of environmental – to – gravity loads ratio (We/G). The reliability index was determined for both codes under the following parameters:

TABLE III
 PARAMETERS FOR TYPICAL JOINTS RELIABILITY ANALYSIS

Parameter	Value
Dead : Live load ratio,	1:1
Environmental Load factor, γ_w	1.35
Dead load factor, γ_D	1.10
Live Load factors, γ_L	1.10
Resistance factors, γ_R	1.05
Qf factor	1.00
Factor of Safety, FS	1.67(1.25)

1. Axial Tension

The results for a typical joint are shown in Figure 7 to Figure 9. It can be seen that, for all codes the reliability tends to decrease and then remains constants beyond the We/G load ratio of 10. The API RP2A - WSD and ISO values are about the same for the T/Y-joints and X-joints. However, the ISO values are lower than API RP2A - WSD for the K-joint.

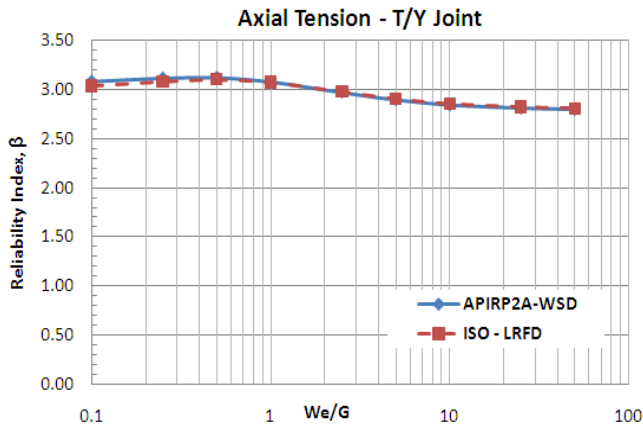

Fig. 7 T/Y-Joint Axial Tension – effect of variation in We/G on β

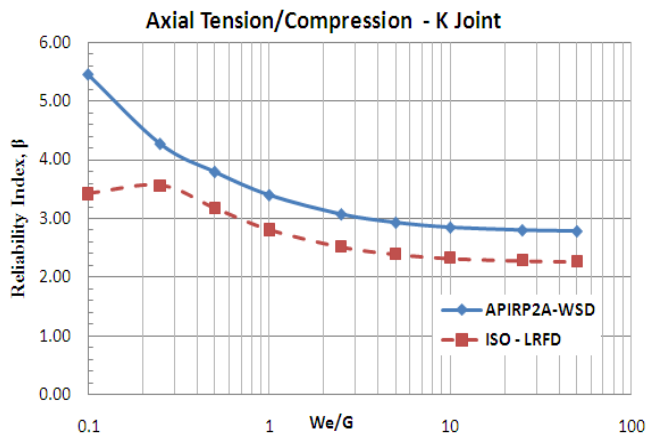

Fig. 8 K – Joint Axial Tension – effect of variation in We/G on β

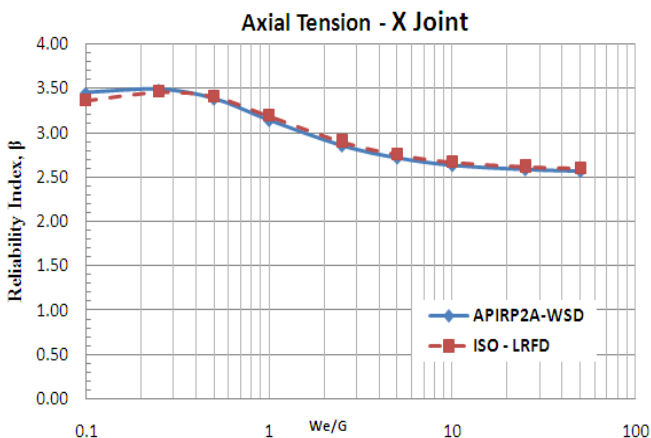

Fig. 9 X – Joint Axial Tension – effect of variation in We/G on β

2. Axial Compression

The results of reliability index for a typical joint under Axial Compression are shown in Figure 10 and Figure 11. The values of K-Joint under axial compression have not been plotted, as the formulation to obtain the compressive joint strength is the same as for tension (see Figure 8). It observed that the values of ISO are relatively higher T/Y- joint.

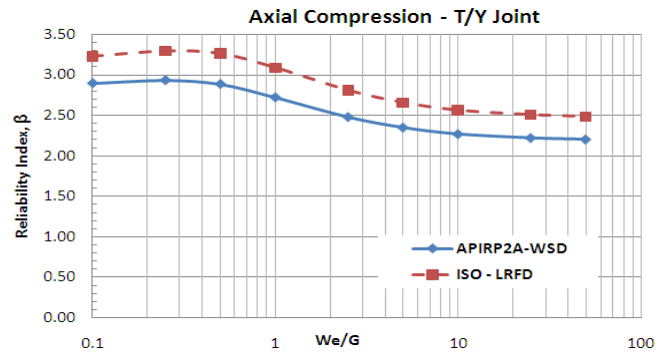

Fig. 10 T/Y – Joint Axial Compression – effect of variation in We/G on β

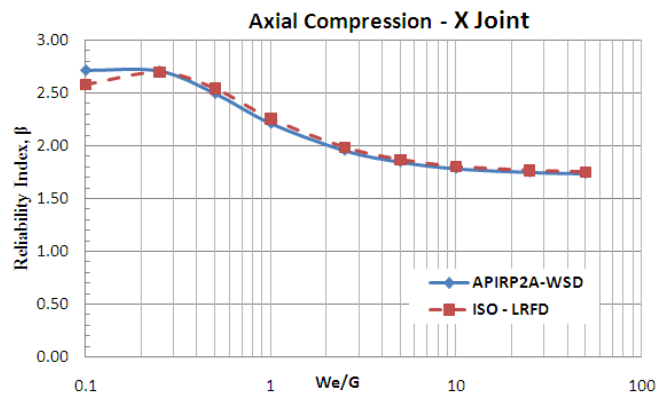

Fig. 11 X – Joint Axial Compression – effect of variation in We/G on β

3. In-Plane Bending

Figure 12 to Figure 14 show the results of the reliability of all joints under the In Plane Bending. It can be seen that in all cases the API RP2A - WSD has higher values that the ISO. Nevertheless the ISO values are relatively consistent.

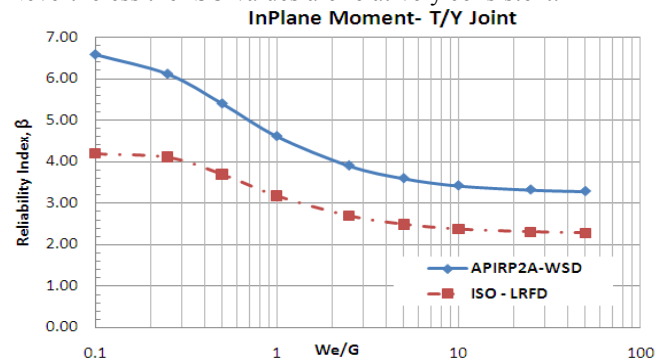

Fig. 12 T/Y – Joint In-Plane Bending – effect of variation in We/G on β

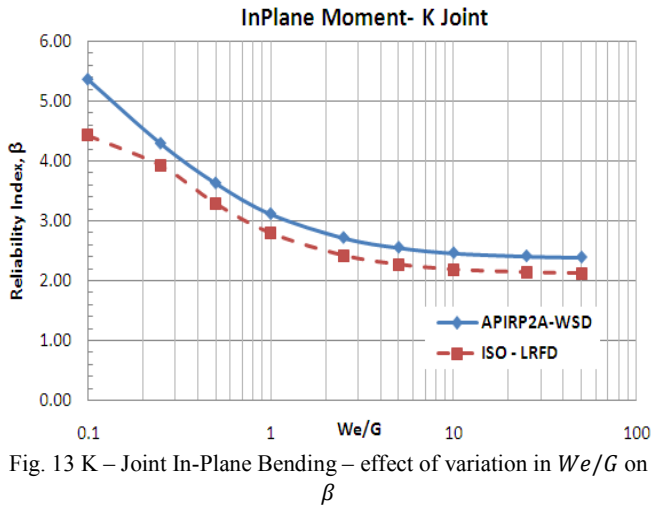

Fig. 13 K – Joint In-Plane Bending – effect of variation in We/G on β

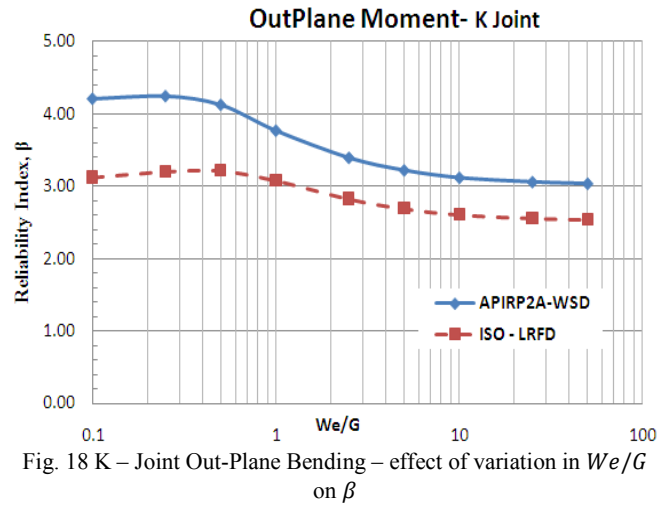

Fig. 18 K – Joint Out-Plane Bending – effect of variation in We/G on β

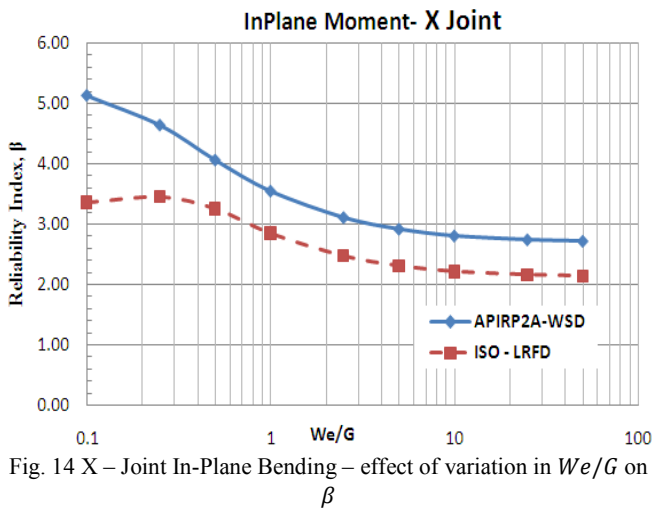

Fig. 14 X – Joint In-Plane Bending – effect of variation in We/G on β

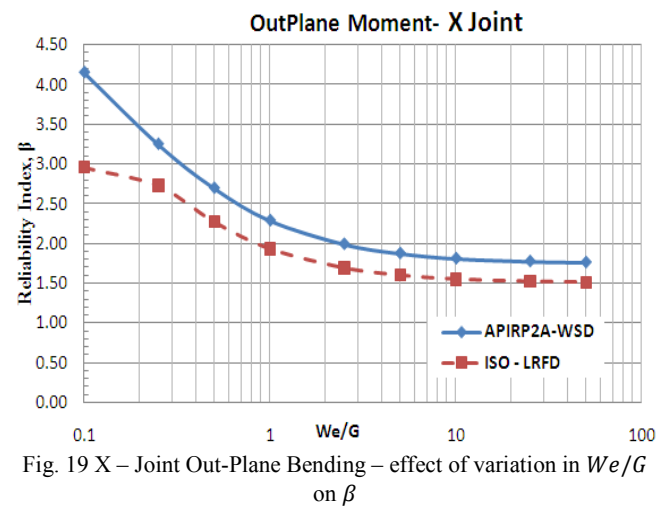

Fig. 19 X – Joint Out-Plane Bending – effect of variation in We/G on β

4. Out-Plane Bending

The results for a typical joint under the effect of Out of Plane Bending can be seen in Figure 15 to Figure 17. The reliability variation with the We/G is similar to that observed in the case of In-Plane Bending.

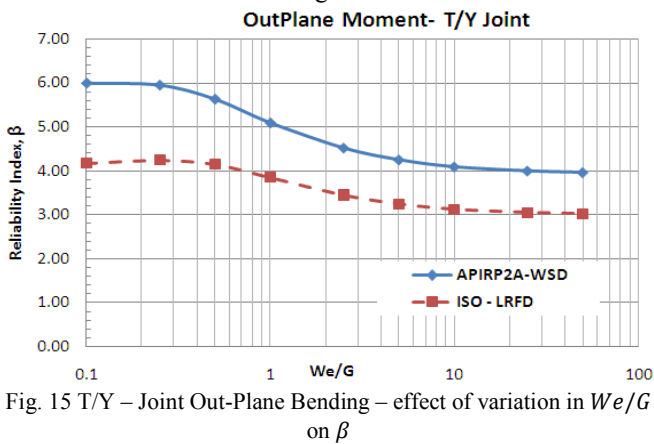

Fig. 15 T/Y – Joint Out-Plane Bending – effect of variation in We/G on β

VIII. CONCLUSION

The reliability analysis of tubular joints of offshore platform has been studied. In this paper only parametric study has been considered. The results show that API RP2A – WSD tends to have reliability index values higher than the ISO code. Overall the reliability index values for ISO is approximately 3.0 for We/G load ratio. Future work will consider other parameters that are linked to the geometry the tubular joint (β and γ , see Figure 5), the variation of the chord load factor Q_f , and the effect of environmental load factors γ_w . The authors also seek to calibrate the load and resistance factors.

ACKNOWLEDGMENT

The authors would like show appreciation to the Center of Graduate Studies of Universiti Teknologi PETRONAS for supporting this project.

REFERENCES

- [1] Idrus, A.B., Narayanan, S. P., Hamid, M. F. A. , Cossa, N. J. , Nizamani, Z., Resistance Parameters Statistics for Jacket Platforms in Offshore Malaysia, *Proceedings of the Twenty-first (2011) International Offshore and Polar Engineering Conference Maui, Hawaii, USA, June 19-24, 2011*, 226-232 , ISBN 978-1-880653-96-8 (Set); ISSN 1098-6189 (Set); www.isopec.org
- [2] Nowak, A. S. and Collins, K.R., *Reliability of Structures*, McGraw-Hill, 2000.
- [3] ISO 2394:1998, *General principles on Reliability for Structures*. International Standards Organization, International Organization Standardization, 1998.
- [4] ISO 19902:2007, *Petroleum and Natural Gas Industries - Fixed Steel Offshore Structures*, 1st Edition, International Organization Standardization, 2007.
- [5] Bomel Ltd “*Component-Based Calibration of North West European Annex Environmental Load Factor to ISO Fixed Steel Offshore Structures Code 19902*,” 2003, Maidenhead, UK.
- [6] Duan, Z.D., Zhou, D.C., Ou J.P., Calibration of LRFD format for steel jacket platforms in China Offshore Area(1) Statistical Parameters of loads and resistances, *China Ocean Engineering*, 2006, 20(1) 1-14
- [7] Duan, Z.D., Zhou, D.C., Ou J.P., Calibration of LRFD format for steel jacket platforms in China Offshore Area(2): Load, resistance and Load Combination Factors, *China Ocean Engineering*, 2006, 20(2) 199-212
- [8] *Tarp-Johansen NJ* , Partial Safety and Characteristic Values for Combined Extreme Wind and Wave Load Effects, Wind Energy Department , Riso National Laboratory 2004
- [9] Idrus, A.B., Narayanan, S. P., Hamid, M. F. A. , Nizamani, Z, Cossa, N. J. , Selection of Environmental Parameters for Offshore Jacket Platform Design in Malaysia. *Advances in Steel and Aluminum Structures(Proc. ICSAS 2011)* , 383-387, ISBN: 978-981-08-9247-0
- [10] Theophanatos, A. , Wickham, A. H. S., Modelling Of Environmental Loading For Adaptation Of API RP 2A - Load And Resistance Factor Design To UK Offshore Structural Design Practice, *Proc. Instn Civ. Engrs Wat. Marit. &Energy*, 1993, 101, Dec., 195-204
- [11] GUMBEL, E.J., 1958. *Statistics of Extremes*. Columbia University Press, New York.
- [12] Neelamani, S.; Al-Salem, K. and Rakha, K., 2007. Extreme waves in the Arabian Gulf. *Journal of Coastal Research*, SI 50 (Proceedings of the 9th International Coastal Symposium), 322 – 328. Gold Coast, Australia, ISSN 0749.0208
- [13] Tan, Chun Chai (2005) *A numerical analysis of fixed offshore structure subjected to environmental loading in Malaysian water*. Master’s thesis, Universiti Teknologi Malaysia, Faculty of Mechanical Engineering
- [14] API RP2A-WSD:2005, *Recommended Practice for planning, design and constructing fixed offshore platforms - Working Stress Design*, 21st Edition, American Petroleum Institute, 2005
- [15] Chakrabarti, S. K., *Hydrodynamics of Offshore Structure*, WIT Press, UK 1987.
- [16] Donders, S., Van de Peer, J. and Schueremans, L. “*Structural Reliability Analysis of a Car Front Cradle with Multiple Design Criteria*” Postdoctoral Research, KU Leuven, Belgium, 2004; <http://www.kuleuven.ac.be/bwk/materials/Research/index.htm>
- [17] Galambos, T. V., *Load and Resistance Factor Design*, National Engineering Conference by AISC, 1981
- [18] Choi, S.K., Grandhi, R., Canfield, R. A., *Reliability-based Structural Design* 1st Edition, Springer, 2007
- [19] Melchers RB. *Structural Reliability Analysis and Prediction*. 2nd Edition; Wiley, Chichester, UK, 1999.

Nelson Julio Cossa is MSc candidate at University Teknologi PETRONAS.

Narayanan Sambu Potty acquired his PhD in Civil Engineering from Indian Institute of Technology Madras, India in 1998 for the work titled “Improving Cyclone Resistant Characteristics of Roof Cladding of Industrial Sheds”. Currently he is working in the areas of steel and composite structures, and construction management. Dr Narayanan is a life member of the Institution of Engineers (India) and Indian Society for Technical Education.

Mohd. Shahir Liew is currently Head of Civil Department, Universiti Teknologi PETRONAS. He achieved PhD in 1988.

Arazi B. Idrus acquired his B.Eng in Civil and Structural Engineering from Sheffield University UK in 1984, M.Sc. on Weapons Effect on Structures from Cranfield University UK in 1994 and PhD from Imperial College University of London UK in 2001 for the work titled “Construction Project Management, Design Processes; Precast and Semi-Precast Construction”. Currently he is working in the areas of construction project management; precast and semi-precast construction; concrete repairs and strengthening. He has worked in JKR as Water Engineer (1984-1986), Assistant District Engineer (1986-1992), and Jurutera Rekabentuk (1994-1997). He has worked as Associate Professor in UNISEL (2002-2006) and currently in Universiti Teknologi Petronas (2006- till date) Perak, Malaysia. Dr Arazi is a corporate member of the Institution of Engineers (Malaysia) and PE of Board of Engineers Malaysia. He is Principal Examiner for Professional Interview and Member of the Expert Panel for IT in Construction for the CIDB.