

Signal Generator Circuit Carrying Information as Embedded Features from Multi-Transducer Signals

Sheroz Khan, Mustafa Zeki, Shihab Abdel Hameed, AHM Zahirul Alam, Aisha Hassan Abdalla, A. F. Salami, and W. A. Lawal

Abstract—A novel circuit for generating a signal embedded with features about data from three sensors is presented. This suggested circuit is making use of a resistance-to-time converter employing a bridge amplifier, an integrator and a comparator. The second resistive sensor (Rz) is transformed into duty cycle. Another bridge with varying resistor, (Ry) in the feedback of an OP AMP is added in series to change the amplitude of the resulting signal in a proportional relationship while keeping the same frequency and duty cycle representing proportional changes in resistors Rx and Rz already mentioned. The resultant output signal carries three types of information embedded as variations of its frequency, duty cycle and amplitude.

Keywords—Integrator, Comparator, Bridge Circuit, Resistance-to-Time Converter, Conditioning Circuit.

I. INTRODUCTION

THE increasing use of microprocessors and microcontrollers in measurement and data acquisition systems has necessitated the need for obtaining transducer response in a form suitable for easy and more accurate conversion to a digital format. Further, automation has reached a stage where wireless transmission of data signals over narrow gaps is required. The data acquired is from transducers measuring parameters of interest for monitoring or other reasons.

Resistance changes are converted into a digital signal with a frequency or time-period directly proportional to these resistance changes in the case of resistive sensors [1-2], and thus changes in resistive sensors as a result of parameters changes are obtained as an output signal in digital form. The work can be considered as a further extension to what is already discussed in [3] which is enhanced by adding another bridge circuit in series. The added element is used to show that resistor variations bring about linear changes in the amplitude of the resultant output signal.

This will be one of the useful techniques used in reading data signals from more than one transducers at the same time while using the same measurement circuit with a single output signal. The utility and application of this work will be in applications where congestion of wiring access is either impossible or to be avoided for more clarity and better automations.

The simulation of the suggested circuit is carried out using excel tools to show that the suggested circuit can be used to generate an output signal carrying information from three parameters.

Authors are with IIUM, Malaysia. e-mail: sheroz@iiu.edu.my

The amplitude of the o/p voltage is linearly proportional to changes in a resistor (Ry), while changes in another resistor (Rz), are proportional to duty cycle, along with changes in a third resistor (Rx) are shown to be proportional frequency of the same signal. Hence this work is about using the same principles but deriving a signal with information from three resistive transducers such as duty cycle, frequency and amplitude. The simulation results are shown to prove a good level of linearity.

The main idea of the paper can be represented as in the following block diagram:

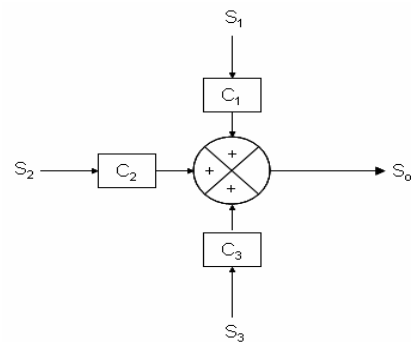

Where: C1, C2 and C3 are the conditioning circuitries which respectively altered the signal of the three sensors S1, S2 and S3. The simple approach to solve is to design and simulate all of the conditioning circuits.

II. DESCRIPTION OF CIRCUIT

A. The New Bridge

The new variable resistor lies on the feedback part of the OP AMP, the derivations below illustrate the linear relationship between the changes in resistor (Ry) as shown in Fig.1. That voltage is equal to in magnitude and opposite in polarity to incremental voltage changes across the varying resistive ΔR . since it is an op-amp, it can be used as a low impedance o/p point for the bridge circuit measurement [5].

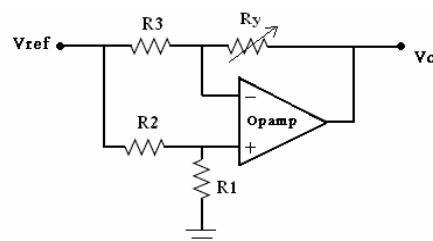

Fig. 1 Changes in resistor

$$\frac{Vi - Vn}{R3} = \frac{Vn - Vo}{Ry} \quad (1)$$

$$Vn = Vp = Vi \left(\frac{R1}{R2 + R1} \right) \quad (2)$$

From equations (1) and (2), we get:

$$Vo = Vi * \left(\frac{RyR1 + R3R1 - RyR2 - RyR1}{R3(R1 + R2)} \right)$$

If $R1=R2=R3=R$ and $Ry=R+\Delta R$ then:

$$\therefore Vo = \left(\frac{-\Delta R}{2R} \right) * Vi \quad (3)$$

Because the o/p is inverted and multiplied by $1/2R$, so we need an inverter with a gain equal to 2, so that the final output $Vout(t) = V0(t)(\Delta R)/R$.

Where $Vout(t)$ is the final o/p signal and $V0(t)$ is the zero crossing detector o/p voltage, so:

$$Vout(t) = V0(t) * \left(\frac{-\Delta R'}{2R} \right) * (-2)$$

$$Vout(t) = V0(t) * (\Delta R' / R)$$

The output voltage amplitude of the ZCD is as shown in Figure 2, which can be derived easily for a known value of resistor, R, hence calculating $\Delta R'$.

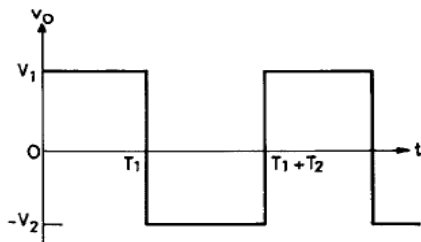

Fig. 2 The Output Signal of Zero-Crossing Detector

B. The Suggested Circuit

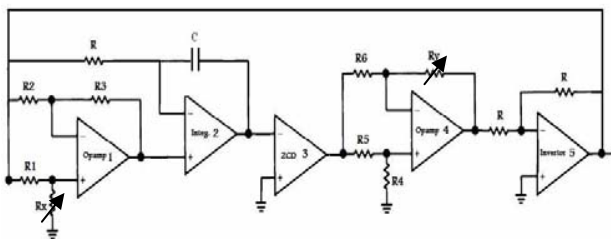

Fig. 3 Suggested Circuit with output signal carrying parameters from multiple transducers

First, we used the connection shown by Fig (3), the o/p of the zero crossing detector is fed to the 2nd bridge then an inverter is suggested to keep the final o/p in phase with the o/p of the zero crossing detector. The suggested connection should be modified, because the o/p of the 2nd bridge starts from zero if there is no change in Ry , i.e. $\Delta R=0$, this is very clear once we notice from equation (3) that the resultant voltage from the 2nd bridge circuit is the i/p multiplied by ΔR due.

Fig. 4 explains how a simple change results in an acceptable behavior from the circuit.

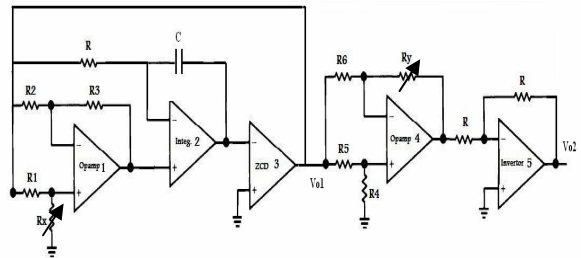

Fig. 4 Modified Suggested Circuit

The circuit diagram in Fig. 4 keeps the oscillator circuit

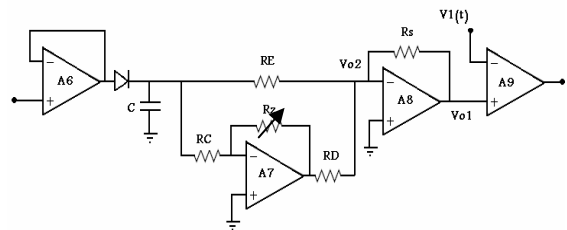

Fig. 5 Simple circuit diagram with two inputs produces a resistor to duty cycle converter.

suggested in [3], and adds the new sensor circuit in series. What ever is the value of the second resistor, the feed back voltage will not be affected. The 2nd advantage is the ability to get a voltage (which is $Vo1$ in the shown Fig.) that carries only the reading of the first sensor, or to get the final o/p, $Vo2$, which carries readings from two different sensors.

C. Resistor to duty cycle circuit and its derivation

The operational amplifier (A6) is connected to the o/p of the comparator (A3), where (A9) compare between the voltage level produced by the change in Ry and the o/p of the integrator (A2). The circuit works as the following: the +ve part of the square wave produced by the comparator (A3) applied to the unity buffer (A6) is reflected on the o/p and C2 is charged to Vs , during the -ve half cycle the diode is off, C2 will discharge towards (A7). Hence the o/p of (A6) is approximately DC with a value equals to Vs . In [4], the proposed circuit looks similar to our work except the capacitor and diode location. We choose the diode and the capacitor to maintain the i/p to (A7) near to DC level voltage. The value of the 3rd sensor, (Rz), determines the level of the voltage, hence the duty cycle.

$$Vo2 = -\left[\frac{Rs}{RE} * Vi + \frac{Rs}{RD} * Vo1\right]$$

$$Vo1 = -\frac{Rz}{Rc} * Vi \Rightarrow Vo2 = Vi * \left[\frac{RzRs}{RD Rc} - \frac{Rs}{RE}\right],$$

Where (Rz) is the varying resistor. The suggested circuit diagram for the three –sensor scheme is shown in Fig.6

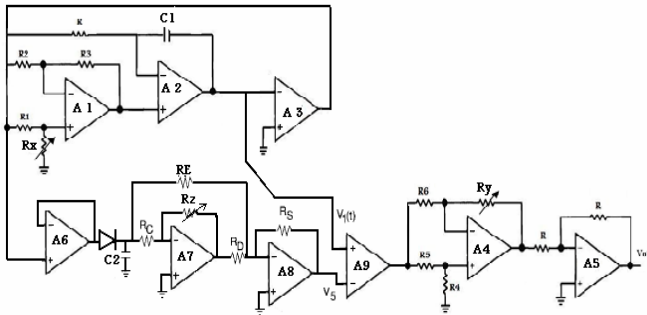

Fig. 6 The complete circuit diagram with three sensors and one o/p voltage carrying three types of information.

III. SIMULATION DETAILS AND ERROR ANALYSIS

We produced plots showing how each sensor, (resistor) produces a certain parameter to be changed in the o/p wave form. The graphs illustrated below are ordered in a way to exhibit how the step by step changes in the o/p and in each step due to a specific sensor.

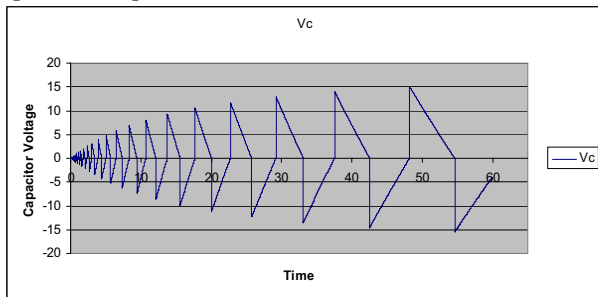

Fig. 7 Changes in time period due to change in Rx

- The first step is the o/p of the integrator circuit. It shows that how the change in resistor (Rx) produces time interval increment as shown in Fig 7.
- The second step is the ZCD produces a square wave with constant amplitude, (Fig.8), which will be the input of the third step where the change in Rz produces changes in the duty cycle.

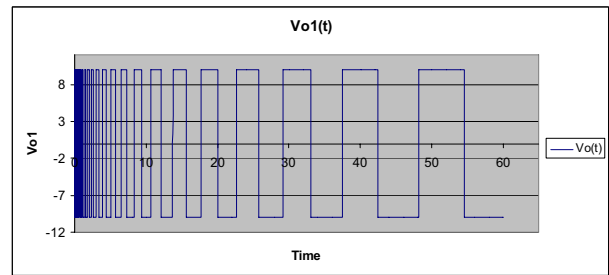

Fig. 8 The time period increases by increasing the value of the resistor Rx

If the above o/p voltage is applied to the circuit shown in Fig.4, it will produce an o/p voltage with the same time period and amplitude proportional to Ry.

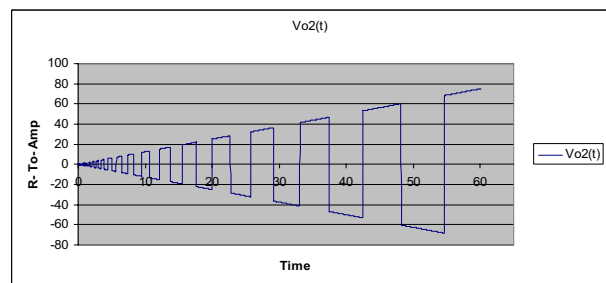

Fig. 9 The amplitude increases by increasing Ry

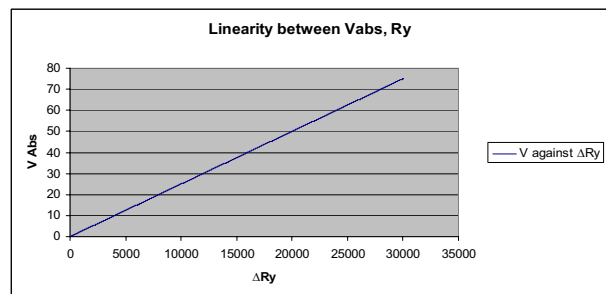

Fig. 10 Shows linear relationship between Amp and Ry

- The third step is changing the duty cycle of the voltage shown in Fig. 8 according to the change in Rz. Fig. 11 shows all the possible values of Rx with a certain value of Rz, its possible to repeat the same simulation using other possible values of Rz.

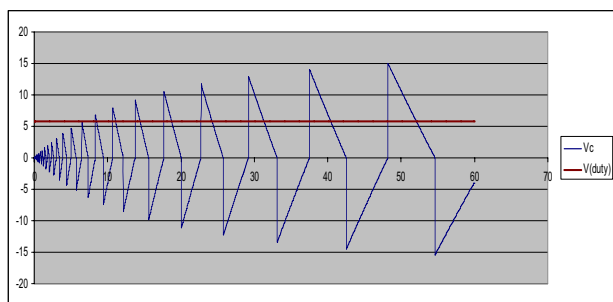

Fig.11 Voltage level for $R_z = 8 \text{ k}\Omega$

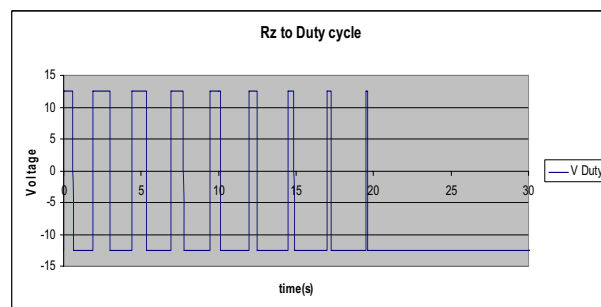

Fig. 14 Output Voltage by varying R_z with a fixed values of R_x and R_y

The simulation results shows the possible range of change for any sensor, Fig. 12 and 13 exhibit that by starting the value of R_x and R_y from 4000Ω with an increment of 5Ω each millisecond, after 8.33 seconds the voltage amplitude of the integrator exceeds the voltage level, i.e. R_z is transformed into duty cycle. The range from 4000Ω to 8160Ω (for R_x and R_y).

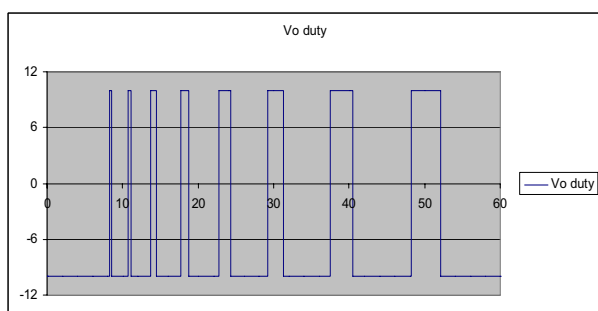

Fig. 12 The amplitude absolute value against ΔR_y

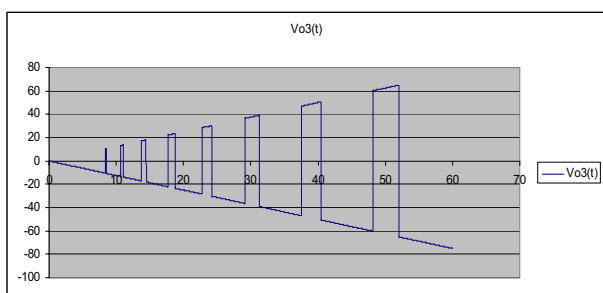

Fig. 13 The final o/p wave form with three types of information

The possible range of change in R_z , which is converted into duty cycle is limited compared to the wide range for the other two sensors, that's clear because the voltage of the o/p signal of the integrator is changing in a nonlinear manner and reaches some point ,(in our case its 15) then it becomes fixed. Also during this time period where the integrator voltage is increasing, the duty cycle is effected by two variables rather than one, and that lead to some error in the readings.

The output voltage of Fig. 14 explains the possible range of change for the third sensor (R_z) and converting that resistance into duty cycle, while the other two sensors, (R_x , R_y) are constant.

IV. CONCLUSIONS

A Suggested R- To- Time, R-To- Amplitude circuit is presented using a simple bridge circuit. From the studying of the possible types of errors, I found that there is a discrete range of time period that give the accurate reading of the resistor due to the injected frequency in the threshold, which is in this case a ground. That discrete range is k times noise frequency (where k is an integer). Also the amplitude range has limits due to the maximum peak to peak o/p voltage of the operational amplifier. The slew rate effect might be reduced by using a tunable active Gm-based current-mode capacitance multiplication circuit instead of the standard Miller compensation capacitor.

REFERENCES

- [1] C. D. Johnson and H. Al. Richeh, "Highly accurate resistance deviation to frequency converter with programmable sensitivity and resolution," IEEE Trans. Instrum. Meas., vol. IM-35, pp. 178-181, 1986.
- [2] K. Mochizuki and K.Watanabe, "A high-resolution, linear resistance-to frequency converter," IEEE Trans. Instrum. Meas., vol. 45, pp. 761-764, 1996.
- [3] S. Kaliyugavaradan "A Linear Resistance-To-Time Converter with High Resolution," IEEE Transaction on Instrumentation and Measurement, Vol. 49, NO. 1, February 2000.
- [4] Vittorio Ferrari, Carla Ghidini, Daniele Marioli, and Andrea Taroni. "Oscillator-Based Signal Conditioning with Improved Linearity for Resistive Sensors," IEEE Transactions on Instrumentation and measurement, Vol. 47, NO. 1, February 1998.
- [5] Walt Kester, Editor, Bridge circuit; 1993
- [6] Ferran Reverter, Manel Gasulla and Ramon Pall'as-Areny. "Analysis of interference effects on period-to-digital conversions" Instrumentation, Sensors and Interfaces Group, Castelldefels School of Technology (EPSC), Technical University of Catalonia (UPC), Avda del Canal Ol'impic s/n, C4, 08860 Castelldefels (Barcelona), Spain