

Simulation of Sloshing behavior using Moving Grid and Body Force Methods

Tadashi Watanabe

Abstract—The flow field and the motion of the free surface in an oscillating container are simulated numerically to assess the numerical approach for studying two-phase flows under oscillating conditions. Two numerical methods are compared: one is to model the oscillating container directly using the moving grid of the ALE method, and the other is to simulate the effect of container motion using the oscillating body force acting on the fluid in the stationary container. The two-phase flow field in the container is simulated using the level set method in both cases. It is found that the calculated results by the body force method coincides with those by the moving grid method and the sloshing behavior is predicted well by both the methods. Theoretical background and limitation of the body force method are discussed, and the effects of oscillation amplitude and frequency are shown.

Keywords—Two-phase flow, simulation, oscillation, moving grid, body force

I. INTRODUCTION

Thermal-hydraulic phenomena with two-phase flows are seen widely in nuclear engineering fields, and predictions of complicated interfacial phenomena are of practical importance. Characteristics of two-phase flows have been intensively studied both experimentally and numerically under wide variety of flow conditions concerning with nuclear reactor safety. Two-phase flow phenomena under seismic conditions are, however, not well known. Free surface behaviors of liquid sodium have been studied for fast breeder reactors (FBRs). Numerical simulations were performed in some studies to obtain the surface motion, where the motion of reactor tank was taken into account as the external acceleration term in fluid equations [1,2]. Stability analyses of boiling water reactors (BWRs) under seismic conditions have been performed by modifying the safety analysis code TRAC-BF1 to take into account the effect of seismic oscillation on thermal hydraulics [3]. The oscillating acceleration was added to the momentum equation of two-phase flows as an external body force term and the coupled effect of the thermal hydraulics and the reactor point kinetics was discussed. Three-dimensional effects have been studied later by coupling TRAC-BF1 with a three-dimensional kinetics code [4], and spatial distributions of void fraction and core power were shown to be affected. In these studies, seismic effects on thermal-hydraulics were modeled through the additional body force term in the fluid equations, instead of taking into account the oscillation of reactor components. Although the method using the external

body force could easily be applied for reactor safety analyses, validation of this methodology has not yet been discussed. In this study, the two-phase flow field and the motion of the free surface in an oscillating container are simulated numerically as a sample problem of the thermal-hydraulic behavior under seismic conditions, and the numerical approach using the body force is studied. The growth of the surface wave in a partially filled oscillating container is known as sloshing, and is important for structural integrity of the container. The effect of oscillating container on fluid motion was, in some cases, taken into account by including a body force induced by the container motion in the momentum equation of fluid [5], as was the case for FBRs and BWRs. The computational grid for fluid simulation was, in other cases, moved directory according to the container motion [6]. Although the method using the body force is easy from the view point of numerical simulation, the method using the moving grid seems apparently to be corresponding to the real phenomena. A simple sloshing experiment [7] is simulated in the following using the moving grid first. A stratified two-phase flow is contained in a rectangular container, and the container is set in an oscillatory motion. Incompressible Navier-Stokes equations are solved using the level set method [8]. In the level set method, the level set function, which is the distance function from the free surface, is calculated by solving the transport equation using the flow velocities. The motion of the container is modeled by the Arbitrary Lagrangian-Eulerian (ALE) method [9], where the computational grid points are moved with the velocity of the container. Both the liquid-phase and the gas-phase flow fields with the free surface motion induced by the oscillating container are thus obtained in this study. It is shown by comparing the simulation results with the experimental results that the sloshing behavior of the free surface is predicted well using the moving grid. The simulation results are compared next with the case using the body force, and the numerical approach using the body force is discussed. The effects of amplitude and frequency on the simulation results are also shown.

II. NUMERICAL SIMULATION

A. Governing Equations

Governing equations for the two-phase flow field are the equation of continuity and the incompressible Navier-Stokes equations:

$$\nabla \cdot u = 0 \quad (1)$$

T. Watanabe is with the Center for Computational Science and e-Systems, Japan Atomic Energy Agency, Tokai-mura, Naka-gun, Ibaraki-ken, 319-1195, Japan (phone: 81-29-282-5029; fax: 81-29-282-6728; e-mail: watanabe.tadashi66@jaea.go.jp).

and

$$\rho \frac{D\mathbf{u}}{Dt} = -\nabla p + \nabla \cdot (2\mu\mathbf{D}) - F_s + \rho\mathbf{g} \quad (2)$$

where ρ , \mathbf{u} , p and μ , respectively, are the density, the velocity, the pressure and the viscosity, \mathbf{D} is the viscous stress tensor, F_s is a body force due to the surface tension, and \mathbf{g} is the gravitational acceleration. The surface tension force is given by

$$F_s = \sigma\kappa\delta\nabla\phi \quad (3)$$

where σ , κ , δ and ϕ are the surface tension, the curvature of the interface, the Dirac delta function and the level set function, respectively. The level set function is a distance function defined as $\phi=0$ at the free surface, $\phi<0$ in the liquid region, and $\phi>0$ in the gas region. The curvature is expressed in terms of ϕ :

$$\kappa = \nabla \cdot \left(\frac{\nabla\phi}{|\nabla\phi|} \right) \quad (4)$$

The density and viscosity are given, respectively, by

$$\rho = \rho_l + (\rho_g - \rho_l)H \quad (5)$$

and

$$\mu = \mu_l + (\mu_g - \mu_l)H \quad (6)$$

where the subscripts g and l denote gas and liquid phases, respectively, and H is the smeared Heaviside function defined by

$$H = \begin{cases} 0 & (\phi < -\varepsilon) \\ \frac{1}{2} \left[1 + \frac{\phi}{\varepsilon} + \frac{1}{\pi} \sin\left(\frac{\pi\phi}{\varepsilon}\right) \right] & (-\varepsilon \leq \phi \leq \varepsilon) \\ 1 & (\varepsilon < \phi) \end{cases} \quad (7)$$

where ε is a small positive constant for which $\nabla\phi=1$ for $|\phi| \leq \varepsilon$. The time evolution of ϕ is given by

$$\frac{D\phi}{Dt} = 0 \quad (8)$$

In this study, the ALE method is applied, and the computational grid is moving with the same velocity as the velocity of the oscillating container. The substantial derivative terms in (2) and (8) are thus defined by

$$\frac{D}{Dt} = \frac{\partial}{\partial t} + (\mathbf{u} - \mathbf{U}) \cdot \nabla \quad (9)$$

where \mathbf{U} is the velocity of the computational grid.

In order to maintain the level set function as a distance function, an additional equation is solved:

$$\frac{\partial\phi}{\partial\tau} = (1 - |\nabla\phi|) \frac{\phi}{\sqrt{\phi^2 + \alpha^2}} \quad (10)$$

where τ and α are an artificial time and a small constant, respectively. The level set function becomes a distance function in the steady-state solution of the above equation. The following equation is also solved to preserve the total mass of liquid and gas phases in time [10]:

$$\frac{\partial\phi}{\partial\tau} = (M_o - M)(1 - \kappa) |\nabla\phi| \quad (11)$$

where M denotes the mass corresponding to the level set function and M_o denotes the mass for the initial condition.

The finite difference method is used to solve the governing equations. The staggered mesh is used for spatial discretization of velocities. The convection terms are discretized using the second order upwind scheme and other terms by the central difference scheme. Time integration is performed by the second order Adams-Bashforth method. The SMAC method is used to obtain pressure and velocities.

B. Simulation conditions

The simulation conditions are almost the same as the conditions of the sloshing experiment [7]. The size of the container is 1.0 m x 1.2 m x 0.1 m, and the initial water level is 0.5 m as shown in Fig. 1.

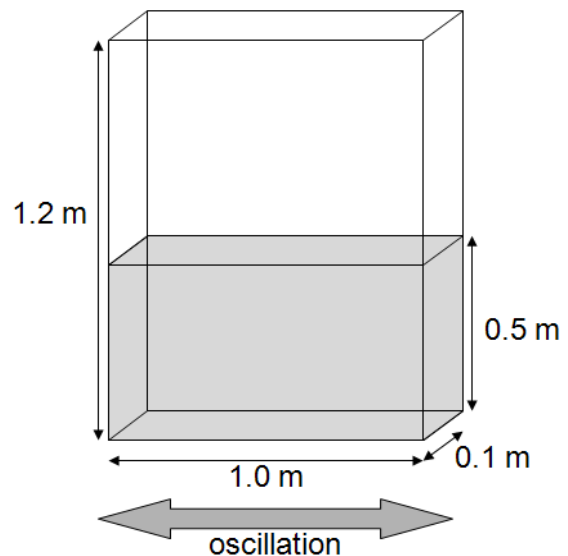

Fig. 1 Experimental condition

The container is set in an oscillatory motion in one horizontal direction. The oscillation of the container location in the horizontal direction is given by

$$x = A \sin(\omega t) \quad (12)$$

where $A = 0.0093$ m and $\omega = 5.311$ rad/s are, respectively, the amplitude and the angular frequency of the oscillation. The velocity of the computational grid is used in the present moving grid method and is given as the differential of the container location,

$$U = A\omega \cos(\omega t) \quad (13)$$

In this study, the case with the oscillating body force is compared with the moving grid method. The oscillating body force is given as the differential of the container velocity,

$$f = -A\omega^2 \sin(\omega t) \quad (14)$$

The above body force is applied as the external force term in the momentum equation given by (2), and the container is not moved and $U=0$ in (9) for the body force method. The slip boundary conditions are applied at all walls for both the moving grid and the body force methods.

III. RESULTS AND DISCUSSION

A. Comparison with experimental results

The time evolution of the liquid level at the left-side wall is shown in Fig. 2 along with the experimental results [7]. It is shown that the agreement between the simulation and the experiment is satisfactory even for large liquid level.

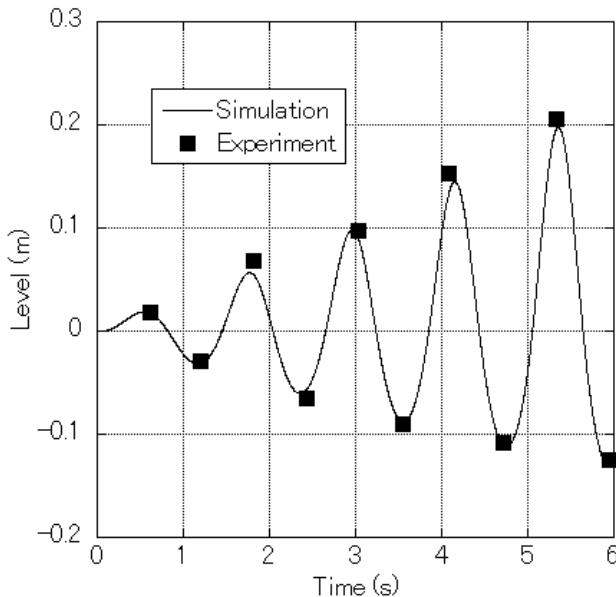

Fig. 2 Time evolution of liquid level

Two-dimensional calculations with 100×120 mesh cells are performed in Fig. 2. Three-dimensional calculations with $100 \times 120 \times 10$ mesh cells were also performed, but the calculated sloshing behavior was the same as the two-dimensional result. The effects of numerical parameters on the calculated results have also been checked, and it was confirmed that the grid dependency was not included in the numerical results shown in Fig. 2. The number of mesh cells is thus 100×120 , and the grid size is 0.01 m in the following. The sloshing experiment is thus found to be simulated well by the present numerical approach using the moving grid.

B. Comparison with body force method

The time evolution of the surface elevation obtained by the body force method is compared with that by the moving grid

method in Fig. 3.

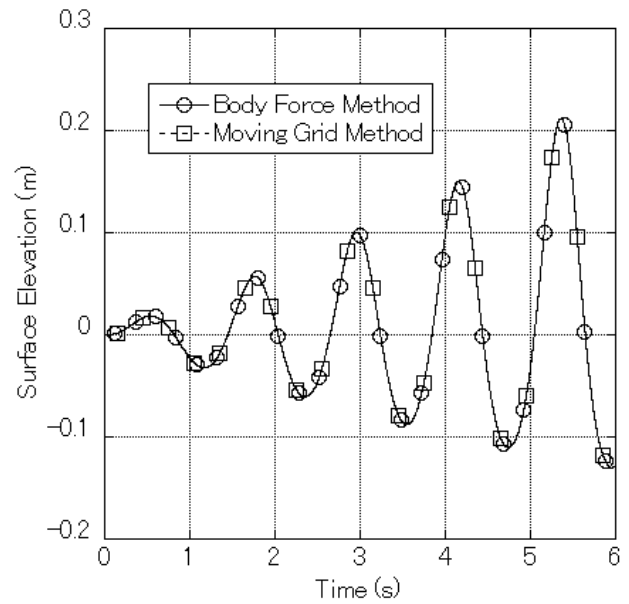

Fig. 3 Comparison of numerical approach

The growth of the surface wave is shown to be the same for the two methods. The difference of the two methods is discussed in the following. The momentum equation for the moving grid method is given by (2) and (9) as

$$\frac{\partial u}{\partial t} + [(u-U) \cdot \nabla]u = -\frac{1}{\rho} \nabla p + \frac{1}{\rho} \nabla \cdot (2\mu D) - \frac{1}{\rho} F_s + g \quad (15)$$

where U is the container or the grid velocity given by (13). The flow velocity is then assumed to be divided into two parts: the grid velocity U and the induced velocity u' ,

$$u = u' + U \quad (16)$$

The momentum equation then becomes

$$\frac{\partial u'}{\partial t} + u' \cdot \nabla u' = -\frac{1}{\rho} \nabla p + \frac{1}{\rho} \nabla \cdot (2\mu D') - \frac{1}{\rho} F_s + g - \frac{\partial U}{\partial t} \quad (17)$$

where D' is the viscous stress tensor for the induced velocity u' . It is assumed in (17) that the grid velocity is not varied spatially.

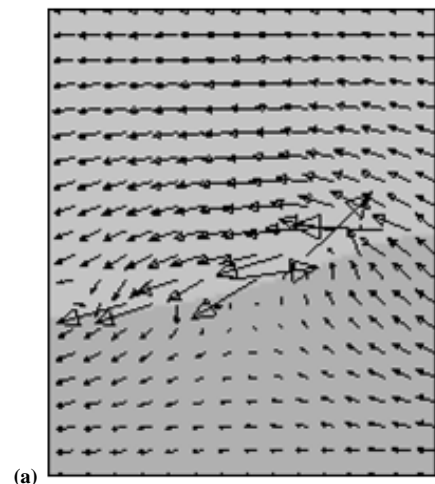

(a)

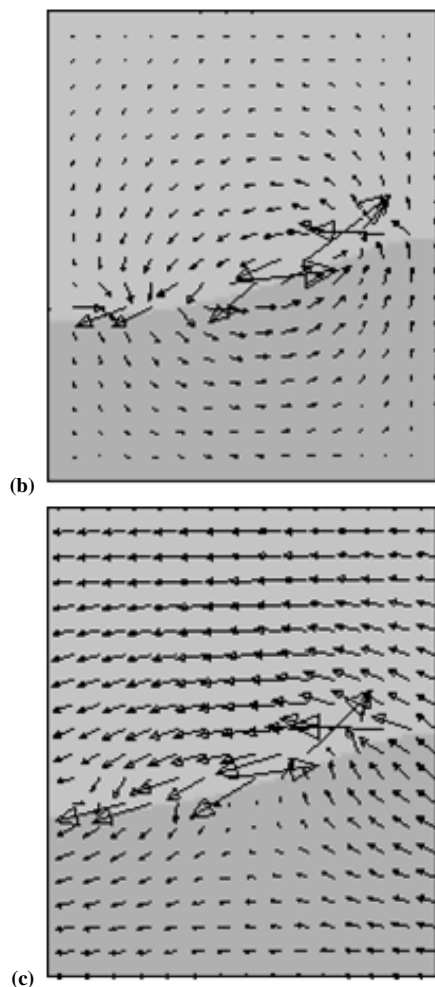

Fig. 4 Flow field: (a) by moving grid method, (b) by body force method, (c) by body force method + oscillation velocity

The last term in the right hand side of (17) is the oscillating body force given by (14), and (17) is the momentum equation for the body force method. It is thus obvious that (15) for the moving grid method is equivalent to (17) for the body force method. The calculated surface elevation by the moving grid method thus becomes the same as the result by the body force method as shown in Fig. 3. It should, however, be noted that the calculated velocity field by the moving grid method includes the grid velocity, while that by the body force method does not. In order to see this difference clearly, the flow fields are compared in Fig. 4, where the shapes of the free surface and the velocity fields at 3.54 s are shown. The velocity field obtained by the moving grid method is shown in Fig. 4(a), the induced velocity field obtained by the body force method is in (b), and the sum of the induced velocity field and the grid velocity is in (c). The induced flow field in (b) calculated by (17) is much different from the velocity field in (a) by (15). It is, however, shown in Fig. 4 that the velocity field by the moving grid method in (a) corresponds to the sum of the induced velocity field by the body force method and the grid velocity in (c). In other words, the velocity field by the moving grid method is

observed on the fixed coordinate, while that by the body force method is on the moving coordinate with the grid velocity. This difference of coordinate system should be reminded for estimation of the calculated results obtained by the body force method.

C. Effects of oscillation amplitude and frequency

In order to see the effects of oscillation amplitude and frequency on the surface elevation, the amplitude A and the frequency ω of container oscillation are, respectively increased in Figs. 5 and 6.

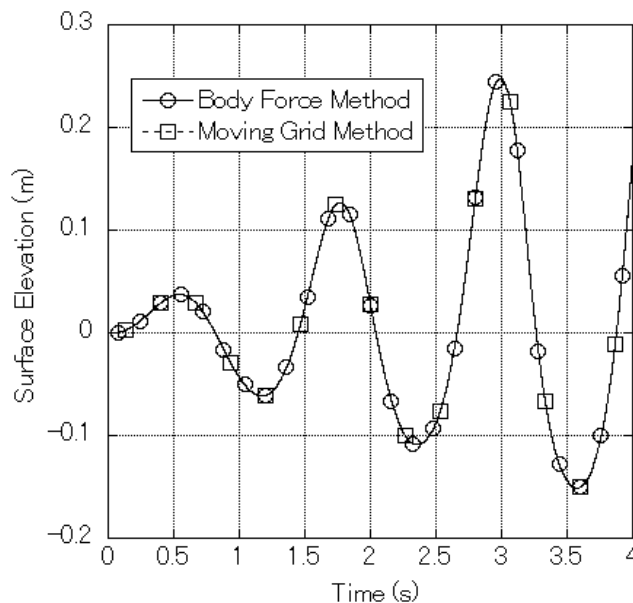

Fig. 5 Effect of oscillation amplitude

The results with two times larger amplitude are shown in Fig. 5. The grid velocity and the body force are simply increased in proportion to the oscillation amplitude of the container according to (13) and (14). It is shown in Fig. 5 that the surface elevation becomes larger with increase in the oscillation amplitude. The elevation is, however, not increased linearly with the amplitude. This nonlinear effect is found to be simulated by both the moving grid and the body force methods, and the calculated results are the same as shown in Fig. 5. The results with two times larger frequency are shown in Fig. 6. It is noted that not only the frequency but also the effective amplitude of the grid velocity become two times larger according to (13) as the oscillation frequency becomes two times larger. Furthermore, the effective amplitude of the body force becomes four times larger according to (14). In any case, the sloshing phenomena with the growth of surface wave are not seen in Fig. 6, since the increased frequency is different from the resonant frequency used in the experiment. Large oscillation does not appear, but complicated surface fluctuations occur. This effect of oscillation frequency is found to be simulated by both the moving grid and the body force methods, and the calculated results are again the same as shown in Fig. 6.

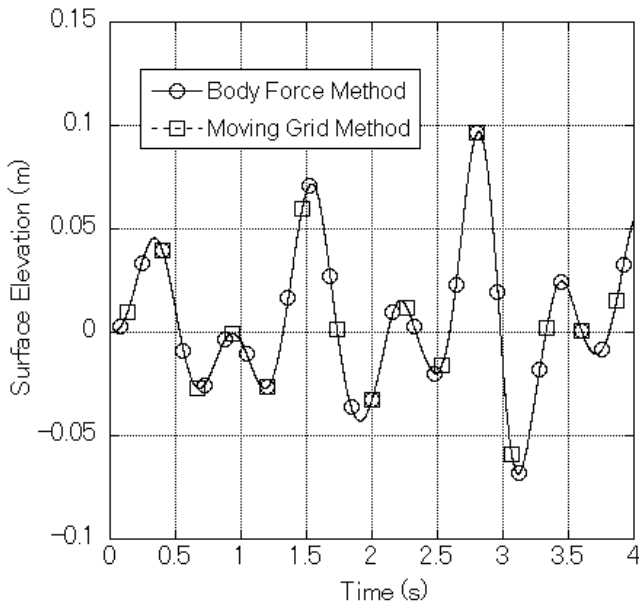

Fig. 6 Effect of oscillation frequency

IV. CONCLUSION

The two-phase flow field and the motion of the free surface in an oscillating container have been simulated numerically to assess the numerical approach for simulating two-phase flows under oscillating conditions. The moving grid method, where the oscillating container was modeled directly using the moving grid of the ALE method with the oscillating velocity, was compared with the body force method, where the effect of container motion was simulated using an oscillating body force acting on the fluid in a stationary container. The two-phase flow field in the container was simulated using the level set method in both cases. It was found from the comparison with the existing experimental results that the sloshing behavior of the free surface was predicted well by the moving grid method. It was shown that the calculated results by the body force method coincided with those by the moving grid method and the momentum equation of the body force method was equivalent to that of the moving grid method. The calculated velocity field by the body force method was, however, the induced velocity field, which did not include the oscillating velocity of the container. It was found that the sum of the induced velocity field and the oscillating velocity was corresponding to the velocity field calculated by the moving grid method. It should be noted that the oscillating velocity was assumed to be spatially constant for the body force method. If whole the simulation region does not move simultaneously, for instance in case of deformation of components under seismic conditions, the body force method is not equivalent to the moving grid method. The governing equations would be complicated for simulating cases with spatially different body forces. The effects of oscillation amplitude and frequency were also shown. The oscillation of surface elevation was increased with increase in the oscillation amplitude of the container. It was shown that the effect of oscillation amplitude of the container could be discussed simply by changing the amplitude of the grid velocity or of the body force. The large sloshing phenomena were not seen and the oscillation of surface elevation became

complicated as the oscillation frequency increased. It was shown that the increase in oscillation frequency of the container corresponded to the increase in effective amplitudes of the grid velocity and the body force. This point should be reminded for discussing the effect of frequency on the results simulated both by the moving grid and by the body force methods. In this study, the simple sloshing experiment was simulated numerically as a sample problem, and the governing equations had no empirical correlations. For simulating engineering two-phase flow problems such as reactor thermal hydraulics under oscillating conditions, two-fluid model codes such as the reactor safety analysis code TRAC would be used generally. Such safety analysis codes include large number of empirical correlations, which are obtained under the static conditions with constant gravitational acceleration. Fluid equations or calculation conditions including the empirical correlations should thus be treated carefully not only for the body force method but also for the moving grid method.

REFERENCES

- [1] K. Amano, R. Iwano and Y. Sibata, "Three-dimensional analysis method for sloshing behavior and its application to FBRs," Nucl. Eng. Des., Vol.140, pp. 297-308, 1993.
- [2] Y. W. Chang, D. C. Ma, J. Gvildys and W. K. Liu, "Seismic analysis of LMR reactor tanks," Nucl. Eng. Des., Vol. 106, 19-33, 1988.
- [3] M. Hirano and T. Tamakoshi, "An analytical study on excitation of nuclear-coupled thermal hydraulic instability due to seismically induced resonance in BWR", Nucl. Eng. Des., vol. 162, pp. 307-315, 1996.
- [4] Satou, A., 2010, Neutron-coupled thermal hydraulic calculation of BWR under seismic acceleration, Proc. Joint Int. Conf. on Supercomputing in Nucl. Applications and Monte Carlo 2010.
- [5] Liu, D., Lin, P., 2008, A numerical study of three-dimensional liquid sloshing in tanks, J. Comp. Phys. 227, 3921-3939.
- [6] Curadelli, O., Ambrosini, D., Mirasso, A., and Amani, M., 2010, Resonant frequencies in an elevated spherical container partially filled with water: FEM and measurement, J. Fluids and Struct. 26, 148-159.
- [7] Okamoto, T., Kawahara, M., 1992, Two-dimensional sloshing analysis by the arbitrary Lagrangian-Eulerian finite element methods. Strut. Eng./Earthquake Eng. 8, 207s-216s.
- [8] Sussman, M., Smereka, P., 1997, Axisymmetric free boundary problems. J. Fluid. Mech. 341, 269-294.
- [9] Hirt, C.W., Amsden, A.A., Cook, J.L., 1974, An Arbitrary Lagrangian-Eulerian Computing Method for All Flow Speeds. J. Comp. Phys. 14, 227-253.
- [10] Chang, Y.C., Hou, T.Y., Merriman, B., Osher, S., 1996, A level set formulation of Eulerian interface capturing methods for incompressible fluid flows, J. Comp. Phys. 124, 449-464.