

An Iterative Algorithm for Inverse Kinematics of 5-DOF Manipulator with Offset Wrist

Juyi Park, Jung-Min Kim, Hee-Hwan Park, Jin-Wook Kim, Gye-Hyung Kang, and Soo-Ho Kim

Abstract—This paper presents an iterative algorithm to find a inverse kinematic solution of 5-DOF robot. The algorithm is to minimize the iteration number. Since the 5-DOF robot cannot give full orientation of tool. Only z-direction of tool is satisfied while rotation of tool is determined by kinematic constraint. This work therefore described how to specify the tool direction and let the tool rotation free. The simulation results show that this algorithm effectively worked. Using the proposed iteration algorithm, error due to inverse kinematics converged to zero rapidly in 5 iterations. This algorithm was applied in real welding robot and verified through various practical works.

Keywords—5-DOF manipulator, Inverse kinematics, Iterative algorithm, Wrist offset.

I. INTRODUCTION

GENERALLY robot developers prefer six degree of freedom(DOF) robot because it can be used for general purpose. Yet this work developed 5-DOF robot because its weight is the most essential point for portability [1]. The robot in this work it to use in arc welding task and its main feature is that is can be carried by human workers. Therefore the robot should be very light and have compact shape which is proper for hand-carry.

As is well known, since 5-DOF robot cannot locate the tool in arbitrary pose, solving inverse kinematics is different from 6-DOF robot. When a target location of tool with specific pose is given, 5-DOF cannot always reach that location and one component of location or orientation should be given up. Gan *et. al.* developed a analytical inverse kinematic solution for their robot[2-3], but their work is valid only for reachable position and orientation. ZXhizhong *et. al.* solved inverse kinematics by adding a virtual joint to 5-DOF robot[4]. They analytically expressed by one variable for all joints and applied one-dimensional iterative Newton-Raphson method to minimize the tip-position error.

Beside the lack of DOF, the robot in this work has wrist offset which makes the inverse kinematics more complicated. Therefore an iterative algorithm is imported to solve inverse kinematics as is done in 6-DOF robot having wrist offset [5-6].

In order to apply an iterative method, a variable is defined that can represent contribution of all joints to the tip error. The iterative algorithm is reinforced to increase the convergence speed. After verifying the effectiveness of the proposed algorithm, it is ported in real robot and applies it to welding task

J. Park *et. al.* are with the Daewoo Shipbuilding and Marine Engineering Co. Ltd., Seoul Korea (phone: 822-3667-3813, fax: 822-3667-3819; e-mail: juyipark@dsme.co.kr).

in shipbuilding yard.

This paper organized as follows: Section II presents a 5-DOF manipulator and its forward kinematics. Section III presents an iterative inverse kinematic solution and Section IV simulation results and real application. Conclusions follow in Section V.

II. 5-DOF MANIPULATOR

A. Kinematic Structure

The developed manipulator is to use in gas welding processes. The gas welding process requires precise tip position control and torch direction but the rotation of torch is not important factor. So the needed degree of freedom of gas welding robot is five. Of course 6-DOF is better in real application because it enable the torch not to rotate during welding motion and supports flexible applications.

The links has offset for special purpose to maximize the portability because it is designed to carry by human hand. It consists of 5 revolute joints and its tool is attached to the 5th link which has an offset as shown in Fig. 1.

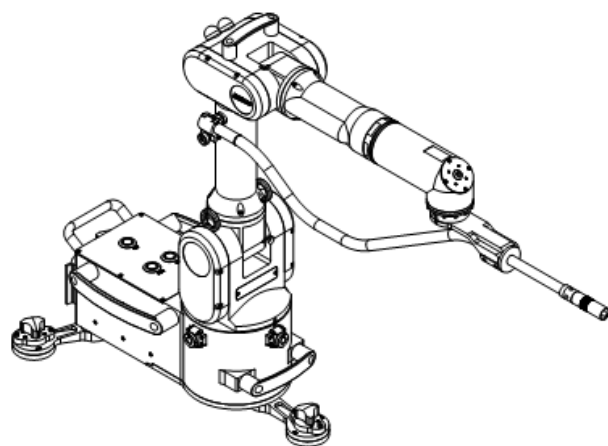

Fig. 1 5-DOF manipulator

Frames for each joint are defined as shown in Fig. 2. As is represented in the figure, a special constant, ψ , is defined to describe the joint original position in common sense. That is, as is shown in figure the second link consists of two links but the 2nd link in Denavit-Hantenberg(DH) notation is different from these links. Therefore the 2nd link and third link is not right angle and might make workers confusing. Table I shows link parameters according to DH notation.

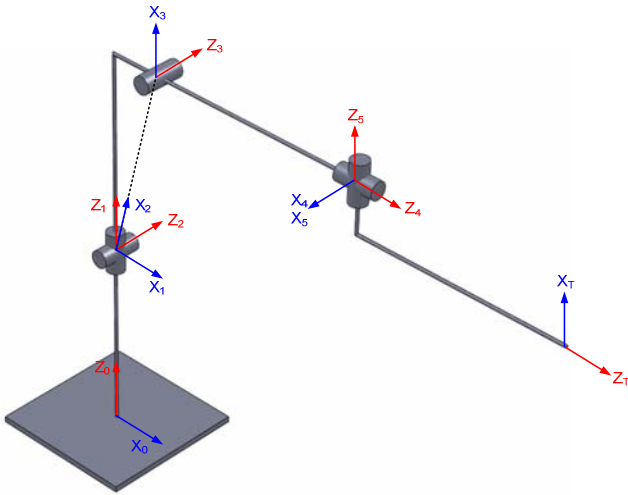

Fig. 2 Definition of frames

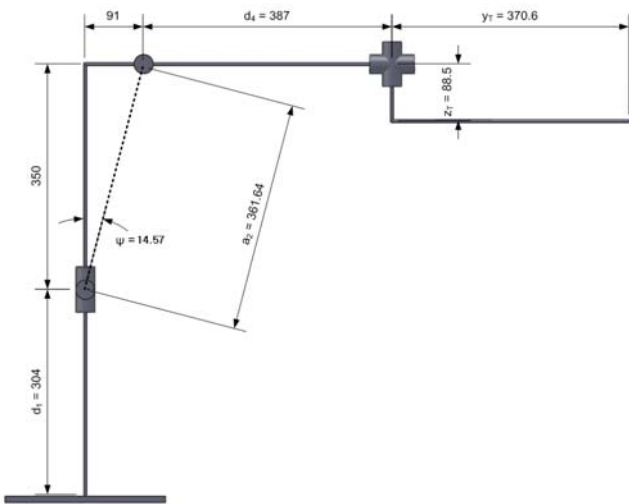

Fig. 3 Length of each link

TABLE I

LINK PARAMETERS ACCORDING TO DENAVIT-HARTENBERG NOTATION

i	α_{i-1}	a_{i-1}	d_i	θ_i
1	0	0	304	θ_1
2	0	-90°	0	$\theta_2 - \psi$
3	361.6	0	0	$\theta_3 - (90^\circ - \psi)$
4	0	-90°	387	θ_4
5	0	90°	0	θ_5

B. Forward Kinematics

Homogeneous transform matrix from base to wrist center is strictly derived from the D-H parameters as follows:

$${}^0T_5 = \begin{bmatrix} o_x & a_x & n_x & p_{5x} \\ o_y & a_y & n_y & p_{5y} \\ o_z & a_z & n_z & p_{5z} \\ 0 & 0 & 0 & 1 \end{bmatrix} \quad (1)$$

Where

$$o_x = c_1 \{-s_{23}s_4c_5 + c_{23}s_5\} + s_1c_4c_5$$

$$o_y = s_1 \{-s_{23}s_4c_5 + c_{23}s_5\} - c_1c_4c_5$$

$$o_z = -c_{23}s_4c_5 - s_{23}s_5$$

$$a_x = c_1 \{s_{23}s_4s_5 + c_{23}s_5\} - s_1c_4s_5$$

$$a_y = s_1 \{s_{23}s_4s_5 + c_{23}s_5\} + c_1c_4s_5$$

$$a_z = c_{23}s_4s_5 - s_{23}s_5$$

$$n_x = c_1s_{23}c_4 + s_1s_4$$

$$n_y = s_1s_{23}c_4 - c_1s_4$$

$$n_z = c_{23}c_4$$

$$p_{5x} = c_1 \{d_4c_{23} + a_2c_{2-\psi}\} = c_1 \{d_4c_{23} + l_2s_2 + l_3c_2\}$$

$$p_{5y} = s_1 \{d_4c_{23} + a_2c_{2-\psi}\} = s_1 \{d_4c_{23} + l_2s_2 + l_3c_2\}$$

$$p_{5z} = d_1 - d_4s_{23} - a_2s_{2-\psi} = d_1 - d_4s_{23} + l_2c_2 - l_3s_2$$

As is mentioned above, welding torch is attached to the link 5 and it has offset from the wrist center (Fig. 4). When its offset from wrist center is ${}^5T P = [0 \ D_y \ D_z]^T$, the tip position and rotation is represented in (2).

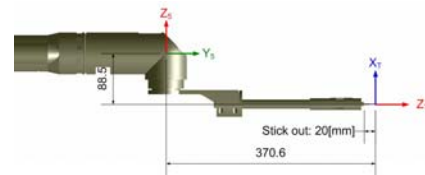

Fig. 4 Tool frame

$${}^0T_T = \begin{bmatrix} {}^0R & {}^0P \\ 0 & 1 \end{bmatrix} = \begin{bmatrix} \mathbf{n} & \mathbf{o} & \mathbf{a} & \mathbf{p} \\ 0 & 0 & 0 & 1 \end{bmatrix}^T, \quad (2)$$

where

$$\mathbf{n} = [n_x \ n_y \ n_z]^T$$

$$\mathbf{o} = [o_x \ o_y \ o_z]^T$$

$$\mathbf{a} = [a_x \ a_y \ a_z]^T$$

$$\mathbf{p} = \begin{bmatrix} p_x \\ p_y \\ p_z \end{bmatrix} = \begin{bmatrix} p_{5x} + a_x D_y + n_x D_z \\ p_{5y} + a_y D_y + n_y D_z \\ p_{5z} + a_z D_y + n_z D_z \end{bmatrix}$$

III. INVERSE KINEMATICS

A. Selection of Components for Inverse Kinematics

Since the 5-DOF robot cannot reach to the every position and orientation specified for the tool, only selected 5 dimensions can be satisfied. That is, one position element or pose should be given up. Otherwise optimal solution can be chosen instead of exact solution.

In this work, the neglected component in orientation is tool's rotation about its direction, z_T , which is defined in Fig. 5. It is reasonable concept because the tool rotation does not induce serious problem in gas welding task while the position and working angle should be controlled precisely.

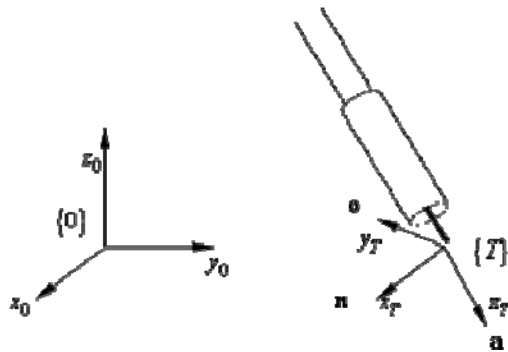

Fig. 5 Vectors related to tool orientation

Since the vectors \mathbf{n} , \mathbf{o} and \mathbf{a} in (2) represent the direction of x_T, y_T and z_T , respectively, the inverse kinematics is solved to realize the given tool position \mathbf{p} and the tool direction vector \mathbf{a} . Other components of orientation, \mathbf{n} and \mathbf{o} , are automatically determined depending on kinematic constraint of the manipulator. In other words, the \mathbf{p} and \mathbf{a} are specified as constraints and let other vectors free.

In this point of view, we defined a variable ϕ to describe the tool rotation about the z-axis of tool frame. Fig. 6 shows the definition of ϕ which is the relative rotational angle of tool to a reference pose. In this work, the pose in initial trial is selected as the reference pose. So the physical meaning of ϕ is the tool's rotation angle from the initial guess. Once the vector \mathbf{a} and ϕ is specified, the rotation matrix can be obtained from the following relation.

$$R = R_0 \begin{bmatrix} c_\phi & -s_\phi & 0 \\ s_\phi & c_\phi & 0 \\ 0 & 0 & 1 \end{bmatrix} \quad (3)$$

On the contrary, ϕ can be calculated as follows when the R and R_0 are given..

$$\phi = \text{atan2}(s_\phi, c_\phi), \quad (4)$$

where

$$s_\phi = R_0(1,2)R(1,1) + R_0(2,2)R(2,1) + R_0(3,2)R(3,1)$$

$$c_\phi = R_0(1,1)R(1,1) + R_0(2,1)R(2,1) + R_0(3,1)R(3,1)$$

$R(j,k)$: j 'th element of the k 'th column of matrix R .

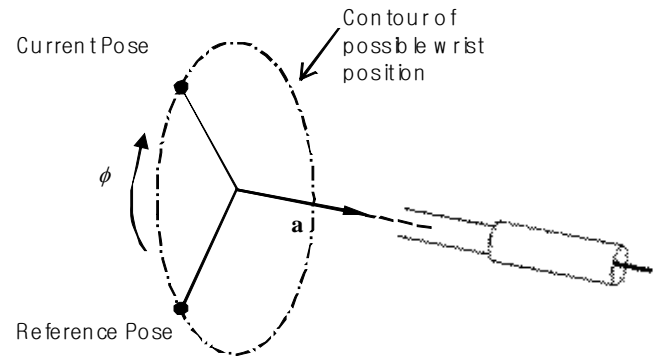

Fig. 6 Possible wrist position and definition of ϕ

B. An Iterative Algorithm

Iterative algorithm for 6-DOF robot with offset joint can be summarized as follows [5-6]:

- Choose initial guess for tool rotation with given tip position and tool direction and then composite rotation matrix, ${}^0_T R$, with this guess.
- Get joints' angle $\Theta = [\theta_1 \dots \theta_5]^T$ by using inverse kinematics with given rotation matrix, which is described in the next sub-section.
- Get tip position and orientation from the forward kinematics with the Θ above.
- Calculated the error between this tip position and desired tip position.
- If the error is smaller than desired level, take Θ as a solution and stop this loop.
- Otherwise, update ${}^0_T R$ based on this error according to an updating rule and repeat it from the step b.

Two important things in this algorithm are how to make initial guess and how to update the desired rotation matrix ${}^0_T R$. For an initial guess, the rotation matrix of current position is used as is done generally in other works. If the displacement of the destination is short from current position this initial guess is very close to the real solution. Generally updating rule in-6DOF is simple; orientation obtained at the step c is used as the next guess. Such updating rule however induces some problems in 5-DOF robot because the robot cannot always reach to the orientation with 5 joints.

In this work, the variable ϕ is updated in the step f instead of replacing the orientation matrix. The rotation angle, ϕ , at the k 'th iteration is defined as ϕ_k and the error vector between desired and calculated tip position is defined as \mathbf{E}_k as shown in Fig. 7.

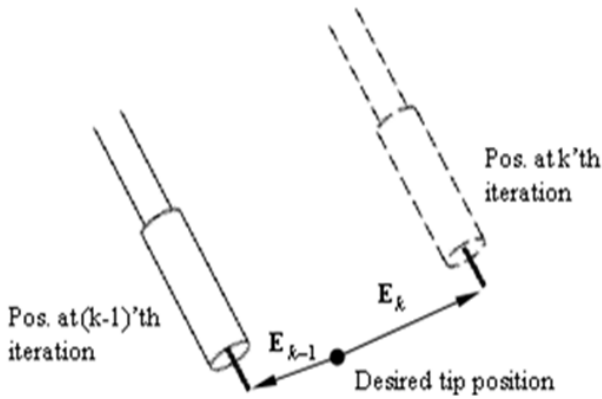

Fig. 7 Definition of error vector

At the k 'th iteration, ϕ_{k+1} is calculated using the following update rule.

$$\phi_{k+1} = \frac{e_{k-1}}{e_{k-1} - \text{sign}(\mathbf{E}_k \cdot \mathbf{E}_{k-1})e_k} (\phi_k - \phi_{k-1}) + \phi_{k-1} \quad (5)$$

where

$$e = |\mathbf{E}|, \\ \text{sign}(x) = \begin{cases} 1 & x \geq 0 \\ -1 & \text{otherwise} \end{cases}$$

Since ϕ_1 cannot be calculated from (5) at the first iteration, it is calculated from ${}^0R_0^*$ which represent the rotation matrix obtained at step c with the initial guess 0R_0 . From the equation (4) ϕ_1 can be calculated as follows when R_k is given.

$$\phi_1 = \text{atan2}(s_{\phi_1}, c_{\phi_1}), \quad (6)$$

where

$$s_{\phi_1} = R_0(1,2)R_1^*(1,1) + R_0(2,2)R_1^*(2,1) + R_0(3,2)R_1^*(3,1) \\ c_{\phi_1} = R_0(1,1)R_1^*(1,1) + R_0(2,1)R_1^*(2,1) + R_0(3,1)R_1^*(3,1)$$

Therefore, iterative algorithm of inverse kinematics for an 5-DOF robot having wrist offset can be summarized as follows:

- Choose initial guess for tool rotation with given tip position and tool direction and composite rotation matrix, 0R , with this guess.
- Get joints' angle $\Theta = [\theta_1 \dots \theta_5]^T$ from inverse kinematics with given rotation matrix.
- Get tip position and orientation from the forward kinematics with the Θ above.
- Calculated the error between this tip position and desired tip position.
- If the error is smaller than desired level take the Θ as a solution and stop this loop.
- Otherwise, update ϕ based on this error according to the updating rule as described below.
- Calculate R with this ϕ and repeat from step b.

C. Inverse Kinematics for Given Position and Orientation

When the tip position 0P and rotation 0R are given, the position of wrist is obtained from the following relation.

$${}^0P_w = {}^0P_s = {}^0\tilde{P}_T - {}^0R_T {}^5\tilde{P} \quad (7)$$

And other processes are same to the well known inverse kinematic solution[2].

$$\theta_1 = \text{atan2}(\tilde{p}_{5y}, \tilde{p}_{5x}) \quad (8)$$

$$\theta_3 = \text{atan2}(s_{3\psi}, c_{3\psi}) - \psi, \quad (9)$$

where

$$c_{3\psi} = \frac{u^2 + v^2 - (d_4^2 + a_2^2)}{2d_4a_2}$$

$$s_{3\psi} = \pm \sqrt{1 - c_{3\psi}^2}$$

$$u = c_1\tilde{p}_{5x} + s_1\tilde{p}_{5y}$$

$$v = \tilde{p}_{5z} - d_1$$

$$\theta_2 = \text{atan2}(s_{23}, c_{23}) - \text{atan2}(s_3, c_3) \quad (10)$$

where

$$c_{23} = \frac{pr \pm q\sqrt{p^2 - r^2 + q^2}}{p^2 + q^2}$$

$$s_{23} = \frac{rq \mp p\sqrt{p^2 - r^2 + q^2}}{p^2 + q^2}$$

$$p = -2ud_4$$

$$q = 2vd_4$$

$$r = a_2^2 - u^2 - v^2 - d_4^2$$

$$\theta_5 = \pm \text{acos}(c_1c_{23}\tilde{a}_x + s_1c_{23}\tilde{a}_y - s_{23}\tilde{a}_z) \quad (11)$$

$$\theta_4 = a \tan 2 \left(\frac{c_1s_{23}\tilde{a}_x + s_1s_{23}\tilde{a}_y + c_{23}\tilde{a}_z}{s_5}, \frac{-s_1\tilde{a}_x + c_1\tilde{a}_y}{s_5} \right) \quad (12)$$

IV. SIMULATIONS AND REAL APPLICATION

A. Simulation Results

Simulations were performed for various target positions with various orientations and the results verified that the proposed algorithm worked effectively. Fig. 8 shows a simulation result for the following current and target position and orientation:

- Current position

$$\Theta = [-45^\circ \quad 30^\circ \quad 30^\circ \quad 90^\circ \quad -90^\circ]^T$$

$${}^T_0P = [151.93 \quad -26.77 \quad 41.16]^T$$

$${}^T_0R = \begin{bmatrix} -0.707 & -0.354 & -0.612 \\ -0.707 & 0.354 & 0.612 \\ 0 & 0.866 & -0.500 \end{bmatrix}^T$$

- Target position: Move to y direction by 450mm keeping tool direction same.

$${}^T_0P = [151.93 \quad 423.23 \quad 41.16]^T$$

$${}^T_0R = \begin{bmatrix} -0.707 & -0.354 & -0.612 \\ -0.707 & 0.354 & 0.612 \\ 0 & 0.866 & -0.500 \end{bmatrix}^T$$

Fig. 10 shows the simulation results. The error of tip position is decreased very fast as iteration goes and became 0.00058 at the 5th iteration. In all cases in simulations, the error decreased less than 0.01mm after 5th iteration.

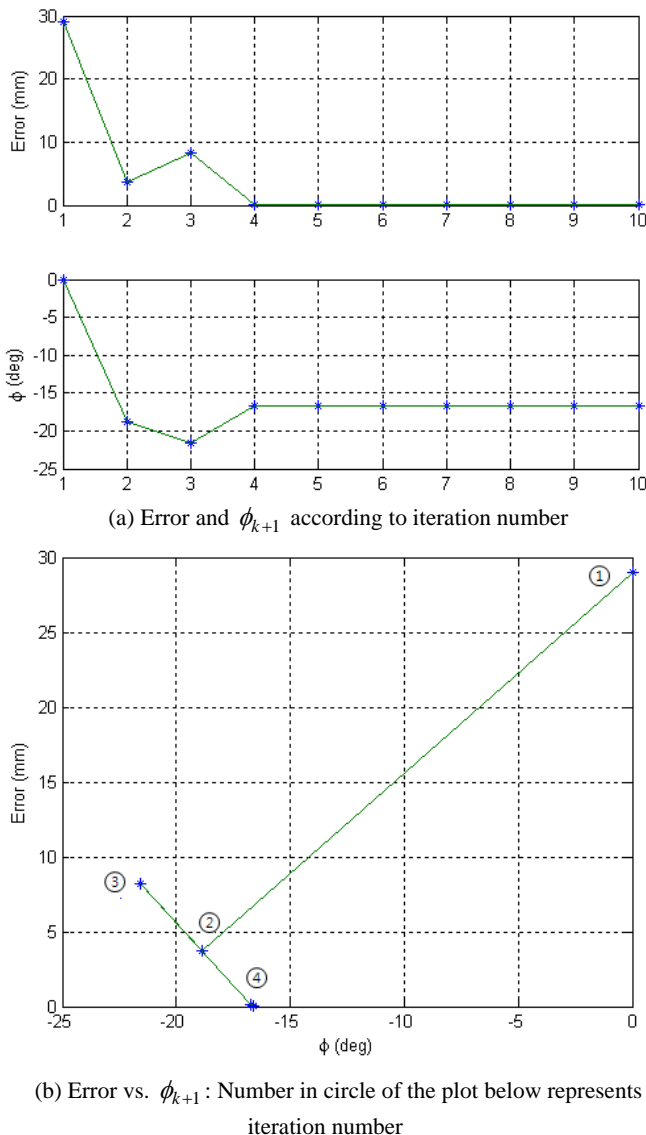

Fig. 8 Simulation results without a reinforced error correction algorithm: Error decreases rapidly as iteration goes

B. Application to a Real Robot

This algorithm applied to real robots for welding task and its effectiveness was verified through various motions. As is designed, the robot could move the tool linearly along the welding line keeping its z direction same while the tool rotated about its z-axis. Since the bead quality in welding task is only depends on the linear motion, the final bead quality by robot welding was very satisfactory.

In real application, there were various type of motion beside linear motion such as Point-to-Point(PTP), circular tip movement keeping the tool direction same, changing orientation keeping the tip position same and so on. From real welding task, the robot did various kind of motion and it was proven that the implemented inverse kinematics worked fine.

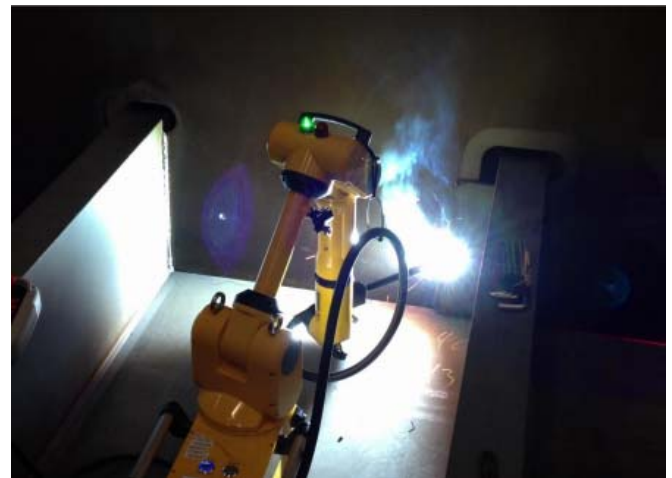

Fig. 9 Application to welding job using iterative algorithm for inverse kinematics

V. CONCLUSION

This work developed an iterative algorithm for inverse kinematics for an 5-DOF manipulator having wrist offset. The algorithm is to minimize the iteration number. Since the 5-DOF robot cannot give full orientation of tool. Only z-direction of tool is satisfied while rotation of tool is determined by kinematic constraint. This work therefore described how to specify the tool direction and let the tool rotation free.

The simulation results show that this algorithm effectively worked. Using the proposed iteration algorithm, error due to inverse kinematics converged to zero rapidly in 5 iterations. This algorithm was applied in real welding robot and verified through various practical works.

REFERENCES

- [1] J. Park *et al.*, "Development of A Portable Welding Robot With EtherCAT Interface," *International Conf. on Manufacturing Engineering and Technology*, 2011.
- [2] J. Q. Gan, E. Qyama, E.M. Rosales, H.Hu, "A complete analytical solution to the inverse kinematics of the Pioneer2 robotic arm," *Journal of Robotica*, 2005, vol. 23, no. 1, pp. 123-129.
- [3] L. ZKhizhong, L. Hongyi and L. Zhong, "Inverse Kinematics Analysis of 5-DOF Robot Manipulators Based on Virtual Joint Method", *Applied mechanics and Materials*, 2012, Vol 143-144, pp. 265-268.

- [4] D. Su, C. A. A. Calderon, J.Q. Gan, H. Hu, "An Analysis of the Inverse Kinematics for a 5-DOF Manipulator", *International Journal of Automation and Computing*, 2005, pp. 114-124.
- [5] R. L. Williams II, "Inverse Kinematics and Singularities of Manipulators with offset wrist," *IASTED International Journal of Robotics and Automation*, 1999, Vol. 12, No. 1, pp. 1-8.
- [6] M. Z. Al-Faiz and M. S. Saleh, "Inverse Kinematics Analysis for Manipulator Robot with Wrist Offset Based on the Closed-Form Algorithm," *International Journal of Robotics and Automation*, 2011, Vol. 2, No. 4, pp. 256-264.
- [7] J. J. Craig, *Introduction to Robotics 2nd Ed.*, Addison Wesley, 1989.