

Deoiling Hydrocyclones Flow Field -A Comparison between k-Epsilon and LES

Maysam Saidi, Reza Maddahian, Bijan Farhanieh

Abstract—In this research a comparison between k-epsilon and LES model for a deoiling hydrocyclone is conducted. Flow field of hydrocyclone is obtained by three-dimensional simulations with OpenFOAM code. Potential of prediction for both methods of this complex swirl flow is discussed. Large eddy simulation method results have more similarity to experiment and its results are presented in figures from different hydrocyclone cross sections.

Keywords—Deoiling hydrocyclones, k-epsilon model, Large eddy simulation, OpenFOAM

I. INTRODUCTION

HYDROCYCLONES are devices which used for centrifugal separation. Compactness, efficiency, reliability and low maintenance costs are their noteworthy characteristics. Although hydrocyclones have been used for industrial purposes more than hundred years but in the recent years, application of liquid-liquid separators becomes vast. Dewatering hydrocyclones can be used to refine crude oil [1] and deoiling hydrocyclones can be used in offshore platforms to refine oily waste water [2]-[3].

The first idea of using common hydrocyclones for oil-water separation was suggested by Simkin and Olney [4] and Sheng, Welker and Sliepcevic [5] but fundamental studies on deoiling hydrocyclones was started from 1980 by Colman and Thew. Several experimental researches on deoiling hydrocyclones were conducted by Colman [6], Colman, Thew and Corney [7] and Colman and Thew [8]-[9].

Hydrocyclone flow is a complex swirling flow and regarding influence of flow field on separation process, exact pressure and velocity field is essential for numerical simulation. Selection of appropriate turbulence model and boundary conditions is the key of a successful simulation. It should be noted that numerical errors can decay results completely.

Many researchers simulate hydrocyclones by using different turbulence models but there is not any work which has been

done for small diameters deoiling hydrocyclones by using large eddy simulation. In this paper LES results of a deoiling hydrocyclone are presented. Also a comparison between k-epsilon and LES results is reported. The second phase effect on first phase flow field can be waived and it is not a far assumption in applications [10]. Simulations have been carried out by OpenFOAM code on two machines with Intel Core-i7 processor and 6 GB of Ram has been paralleled.

II. TURBULENCE MODELING

Three well-known types of turbulence models are Direct Numerical Simulation (DNS), Large Eddy Simulation (LES) and Reynolds Averaged Navier Stokes (RANS). k- ϵ is the simplest one and uses whole averaging. Although it can be accurate for different problems but it is not suitable for unsteady problems, because the averaging process wipes out most of the important characteristics of a time dependent solution. On the other hand, DNS solves all time and spatial scales. This method is too expensive and is not possible to use for many applications.

The following expression is used to calculate turbulent viscosity in the k- ϵ model:

$$\nu_T = C_\mu \frac{k^2}{\epsilon} \quad (1)$$

The turbulent kinetic energy (k) and the energy dissipation rate (ϵ) are calculated from their conservation equations. Further details of k-epsilon model can be found in [11].

Large eddy simulation is a turbulence flow model which is attracted many attentions in recent years. At 1967 Joseph Smagorinsky proposed it for weather studies [12]. Many of the issues unique to LES were first explored by Deardorff [13]. LES operates on the Navier-Stokes equations and decreases computational costs by reducing the range of solution length scale. Smagorinsky [12] used following expression to calculate the turbulent kinematic viscosity:

$$\nu_T = (C_S \Delta)^2 |S| \quad (2)$$

Where C_S is a model constant and S is the characteristic filtered rate of strain tensor and Δ is filter width. Smagorinsky constant is found to vary in the range from 0.065 [14] to 0.25 [15] depends on flow and geometry. Setting this constant is a disadvantageous of this model. Germano et al. [16] proposed a

Maysam Saidi is Ph.D. student at Mechanical Engineering Department of Amirkabir University of Technology. He was M.Sc. student at Mechanical Engineering Department of Sharif University of Technology, Azadi Ave., Tehran, Iran (phone: +98-21-66165524; fax: +98-21-66000021; email: maysam.saidi@gmail.com).

Reza Maddahian is Ph.D. student at Mechanical Engineering Department of Sharif University of Technology, Azadi Ave., Tehran, Iran (email: r_maddahian@mech.sharif.edu).

Bijan Farhanieh is Professor at Mechanical Engineering Department of Sharif University of Technology, Azadi Ave., Tehran, Iran (e-mail: bifa@sharif.edu).

dynamic SGS model in which C_S is calculated and is not an arbitrary chosen value. The main idea behind dynamic smagorinsky model consists in introducing a test filter ($\hat{\Delta}$) with larger width than the original one. This filter is applied to the filtered Navier-Stokes equation. C_S would be:

$$C_S = -\frac{1}{2} \frac{L_{ij} M_{ij}}{M_{ij} M_{ij}} \quad (3)$$

$$\text{Where } L_{ij} = \overline{\overline{u_i u_j}} - \widehat{u_i} \widehat{u_j} \text{ and } M_{ij} = [\widehat{\Delta}^2 |\widehat{S}| \widehat{S}_{ij} - \Delta^2 |\widehat{S}| \widehat{S}_{ij}]$$

Further details of this turbulence model can be found in [16]-[17]. LES model which be used in this work is dynamic smagorinsky model.

III. GEOMETRY AND FLOW CONDITIONS

Simulations are acted on a hydrocyclone with 35 mm of diameter and two symmetrical inlets (5mm*10 mm) which enter tangentially from top of its cylindrical section. It has two outlets, one at its top named overflow and the other at its bottom named underflow. Overflow is continued to internal of the hydrocyclone with the length of L_o which its name is vortex finder. Figure 1 shows detailed dimension. This hydrocyclone is designed for oily waste water refinement. Inlet oil concentration is less than 0.3 vol. %. [10]

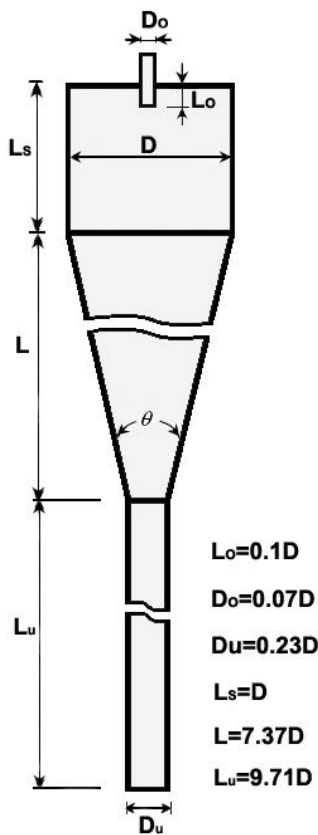

Fig. 1 Hydrocyclone geometry dimensions

Flow split is defined as the ratio of the volume flow of the overflow to that of the inlet and it is in the range of 0.02~0.10 in present work.

Inlet velocity is uniform value of 4.167 m/s (1.5 m³/h of flow rate).

IV. GRID RESOLUTION AND BOUNDARY CONDITION

Figure 2 shows images of grid used in simulation. Except center cylinder with diameter of overflow and vortex finder which is meshed Quad/Pave, whole of hydrocyclone is meshed with Quad/Map. The grid parameters are reported in Table I. LES simulation was conducted with Fine mesh.

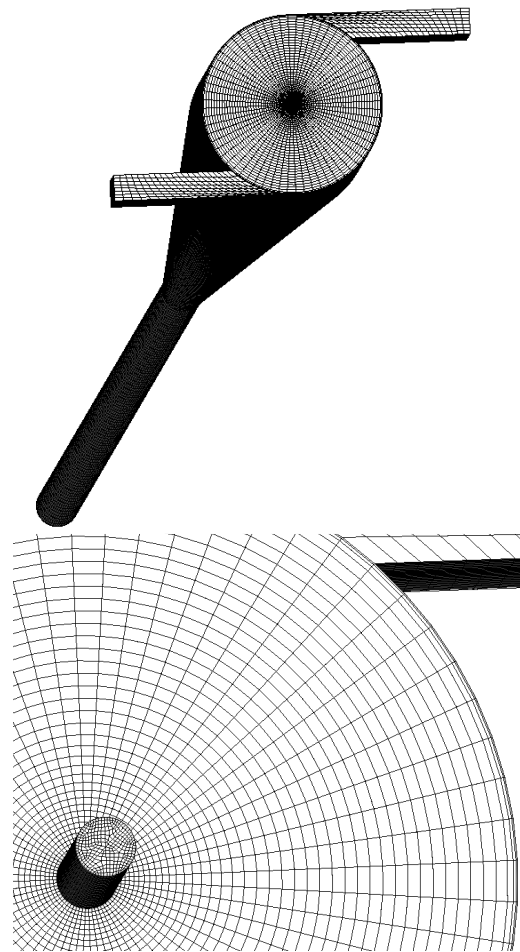

Fig. 2 Generated mesh for hydrocyclone simulations

TABLE I
 NUMBER OF GRIDS IN EACH DIRECTION AND TOTAL OF VOLUME ELEMENTS

	Coarse mesh	Fine mesh
Radial (r)	35	50
Tangential (θ)	48	64
Axial (z)	292	372
Total	434,128	1,025,912

Overflow and underflow are set as constant pressure boundaries. No-slip condition is enforced for velocity and wall function is used in both LES and k-ε for walls. Inlet velocity is uniform value of 4.167 m/s equal to 1.5 m³/h of flow rate. 5% of turbulent intensity is assumed for inlets. Inlet k and epsilon are calculated by below correlations:

$$k = \frac{3}{2}(U \times I)^2 = 0.065 \quad (4)$$

$$\varepsilon = C_{\mu}^{0.75} \frac{k^{1.5}}{l} = 0.58 \quad (5)$$

Where I is inlet turbulent intensity which was 5%, l is length scale (=0.07*d_h) and C_μ = 0.09.

V. NUMERICAL METHOD

An open source CFD code OpenFOAM is used to solve the Navier-Stokes equation. This code is a finite volume solver with collocated grid. Semi-implicit method for pressure-linked equation (SIMPLE) algorithm for k-ε and pressure-implicit split operator (PISO) algorithm for LES is used. Both algorithms are based on evaluating some initial solution and then correcting them. SIMPLE only makes 1 corrector but PISO makes more and it is set by 2 in this simulation.

Preconditioned conjugate gradient solver for pressure and preconditioned bi-conjugate gradient solver for other parameters are used.

Unbounded second order linear central differencing for U and bounded first order upwind for k and epsilon is used for divergence scheme of k-ε model. Also its laplacian scheme is Gauss linear and gradient scheme is linear too. Bounded first order Euler scheme is used for time and linear central differencing is used for diffusion terms of LES model.

VI. RESULTS AND DISCUSSION

Fig. 3 is tangential velocity profile in two different heights of hydrocyclone. It is observed that standard k-ε results are far from experiment. What can be concluded from experiment is that tangential velocity has a shape of Rankine vortex (forced vortex near the center and free vortex in outer region) but k-ε model is forced vortex in most of domain and it could be prospected because of diffusive nature of this model. LES results have better rhythm and its similarity with experiment is acceptable. Prediction power of LES is important despite it is an expensive computational model.

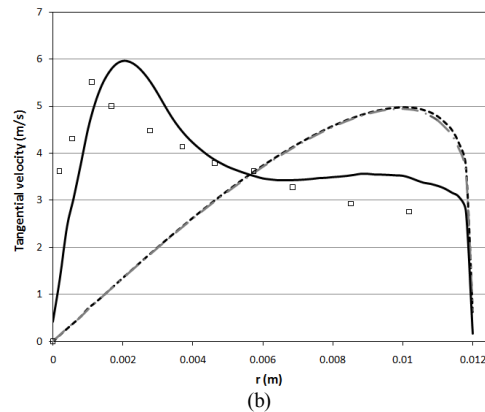
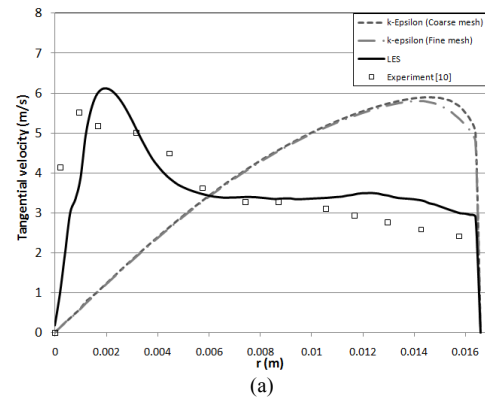
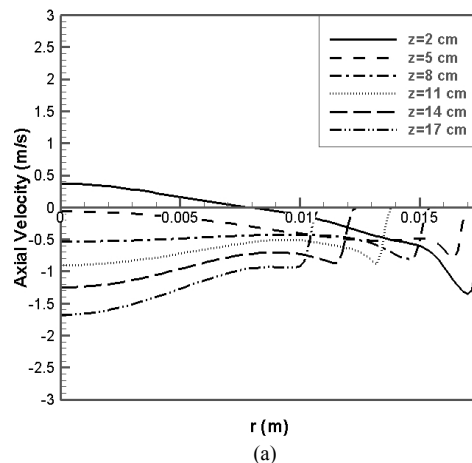

Fig. 3 Tangential velocity profile versus radial position (a: Z=5 cm, b: Z=14cm)

Axial velocity versus radial position is presented in Fig. 4. Effect of forced and free vortex flow can be observed at this figure. Because of higher tangential velocity of LES model in near hydrocyclone center, sharper axial velocity is seen in this model so it is predicted that LES results lead to better separation efficiency. Different heights have different profiles which axial velocity decreases with the height increase from top of hydrocyclone.



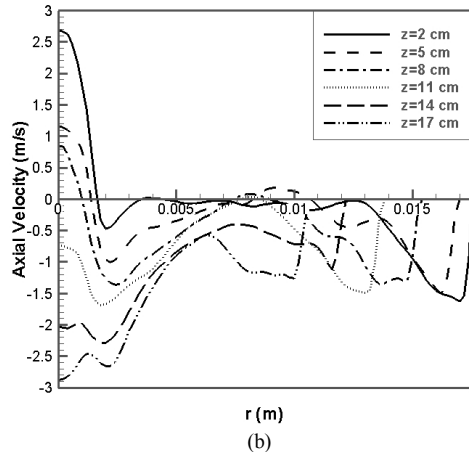

Fig. 4 Axial velocity profile versus radial position (a: k-epsilon, b: LES)

Fig. 5 demonstrates kinematic pressure difference in radial position for two models. As was expected this figure shows another difference between k-epsilon and LES. LES pressure difference toward radial position is three times larger than k-epsilon. It is obvious that pressure gradient versus radial position is cause of hydrocyclone flow circulation and its mistake decays the simulation.

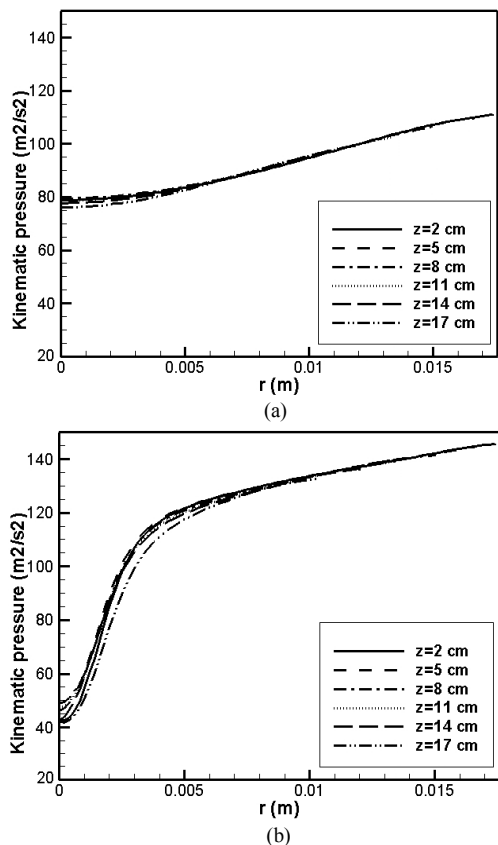

Fig. 5 Pressure gradient versus radial position (a: k-epsilon, b: LES)

VII. CONCLUSION

Velocity and pressure distribution inside deoiling hydrocyclones are obtained by using OpenFOAM code. Turbulence model of k- ϵ is not a proper selection for hydrocyclone geometry and its result has high numerical diffusivity. On the contrary, LES results prediction is better and flow prediction by this model has similarity with experiment. Better axial velocity and horizontal pressure gradient in LES lead to better separation prediction. Although it is assumed water is primary phase and oil effect on its flow field is inconsiderable (In real applications it is not a far assumption) but it is suggested to use multiphase methods for separation efficiency prediction. It can be used particle tracking with these data which is a one way coupling multiphase model.

REFERENCES

- [1] A. Belaidi, M. T. Thew, S. J. Munaweera, "Hydrocyclone performance with complex oil-water emulsions in the feed" in *Can. J. Chem. Eng.*, Vol. 81, 2003, pp. 1159-1170.
- [2] C. Gomez, J. Caldenty, S. Wang, "Oil/water separation in liquid/liquid hydrocyclones: part I experimental investigation", in *SPE J.*, Vol. 7, 2002, pp. 353-372.
- [3] R. G. Devorak, "Separation of light dispersions in long hydrocyclones", Master of Science Thesis No. 1338609, Michigan State University, 1989.
- [4] D. J. Simkin, R. B. Olney, "Phase Separation and Mass Transfer in a Liquid-Liquid Cyclone", in *AIChE*, Vol. 2, 1956, pp. 545-551.
- [5] Sheng H. P., Welker J. R., Sliepcevich C. M., "Liquid-Liquid Separation in a Conventional Hydrocyclone", in *The Canadian J. of Chem. Eng.*, Vol. 52, 1974, pp.487-491.
- [6] D. A. Colman, "The Hydrocyclone for Separating Light Dispersions", Ph.D. Thesis, Southampton University, UK, 1981.
- [7] D. Colman, M. Thew, D. Corney, "hydrocyclones for Oil/Water Separation". in *Int. Conf. on Hydrocyclones*, BHRA, Cambridge, United Kingdom, paper 11, 1980, pp. 143-165.
- [8] D. Colman, M. Thew, "Hydrocyclone to Give a Highly Concentrated Sample of a Lighter Dispersed Phase". In *Int. Conf. on Hydrocyclones*, BHRA, Cambridge, United Kingdom, p 15, 1980, pp. 209-223.
- [9] D. Colman, M. Thew, "Correlation of Separation Results From Light Dispersion Hydrocyclones", in *Chem. Eng. Res. Des.*, Vol. 61, 1983, pp. 233-240.
- [10] Z. Bai, H. Wang, S. Tu, "Experimental study of flow patterns in deoiling hydrocyclon", in *Mineral Engineering*, Vol. 22, 2009, pp. 319-323.
- [11] W. P. Jones, B. E. Launder, "The Prediction of Laminarization with a Two-Equation Model of Turbulence", in *International Journal of Heat and Mass Transfer*, Vol. 15, 1972, pp. 301-314.
- [12] J. Smagorinsky, "General circulation experiments with the primitive equations", in *Month. Weather*, Rev. 91, 1963, pp. 99-165.
- [13] J. Deardorff, "A numerical study of three-dimensional turbulent channel flow at large Reynolds numbers", in *Journal of Fluid Mechanics*, Vol. 41 (2), 1970, pp. 453-480.
- [14] P. Moin, J. Kim, "Numerical investigation of turbulent channel flow", in *J. Fluid Mech.* Vol. 118, 1982, pp. 341-377.
- [15] W. Jones, M. Wille, "Large eddy simulation of a jet in a cross flow", in: *10th Symposium On Turbulent Shear Flows*, The Pennsylvania State University, 1995, pp. 41-46.
- [16] M. Germano, U. Piomelli, P. Moin, W.H. Cabot, "A dynamic subgrid-scale eddy viscosity model", in *Phys. Fluids*, 1991, pp. 31760-31765.
- [17] D.K. Lilly, "A proposed modification of the Germano subgrid scale closure method", in *Phys. Fluids A*, Vol. 4, 1992, pp. 633-635.