

Improvement Approach on Rotor Time Constant Adaptation with Optimum Flux in IFOC for Induction Machines Drives

S. Grouni, R. Ibtouen, M. Kidouche, and O. Touhami

Abstract—Induction machine models used for steady-state and transient analysis require machine parameters that are usually considered design parameters or data. The knowledge of induction machine parameters is very important for Indirect Field Oriented Control (IFOC). A mismatched set of parameters will degrade the response of speed and torque control. This paper presents an improvement approach on rotor time constant adaptation in IFOC for Induction Machines (IM). Our approach tends to improve the estimation accuracy of the fundamental model for flux estimation. Based on the reduced order of the IM model, the rotor fluxes and rotor time constant are estimated using only the stator currents and voltages. This reduced order model offers many advantages for real time identification parameters of the IM.

Keywords—Indirect Field Oriented Control (IFOC), Induction Machine (IM), Rotor Time Constant, Parameters Approach Adaptation. Optimum rotor flux.

I. INTRODUCTION

IN recent years significant advances have been made on the control of IM rotor speed, flux and stator current measurements. Digital shaft position encoders are usually used to detect the rotor speed of motors. The speed and flux sensors cause many problems, such as degradation in mechanical robustness, increased cost and volume, lower the system reliability and require special attention to noise. In addition, for some special applications such as very high-speed motor drives and hostile environment, difficulties arise in mounting these sensors [1]-[5].

In the last decade, many researches have been carried on the design sensorless control schemes of the IM.

Most methods are basically based on the Model Reference Adaptive System schemes (MRAS). In [5] the authors used a reactive-power based reference model in both motoring and generation modes, but one of the disadvantages of this

algorithm is its sensitivity to detuning the stator and rotor inductances.

Now, the IM is widely used in many industrial applications due to its reliability, ruggedness and relatively low cost. These parameters are also attractive for use in new generation of electrical transportation systems. They are also widely used in ventilation and heating systems and in many other electrical domestic apparatus. By using the advances of power electronics and DSP technology, the control schemes of the IM are developed from simple scalar control methods or auto-tuning control strategies to FOC and DTC. The Indirect Field Oriented Control (IFOC) is widely applied in real time control when dealing with high performance induction motors drives [4], [5], [6].

In high performance the rotor time constant is a critical parameter for IFOC induction motor drives. Only the recent works have aimed at filling in this gap by providing IFOC with a firm theoretical foundation. The influence of the rotor time constant mismatch on the stability of induction motors under indirect field oriented control. It has been shown that the speed control of induction motors through IFOC is globally asymptotically stable for any constant load torque if the rotor time constant is perfectly known or the error in its estimation is sufficiently small [8]-[13].

The main task of this paper is to present the design of a high performance IM vector control which is robust against rotor time constant variations. These variations are predicted and corrected by using the estimation and adaptation algorithm. This adaptation method is developed to simultaneously estimate the rotor fluxes and the rotor time constant. Simulation results are presented to highlight the effectiveness and robustness control of the proposed control scheme against measurement rotor time constant and load torque variations. In addition, we consider the problem of analytically seeking a reference optimal flux that minimizes total energy.

II. INDUCTION MACHINE MODEL AND CONTROL PROBLEM FORMULATION

A. Dynamic Model of Induction Machines

The IM mathematical model, in space vector notation, established in d-q axis coordinates rotating system is based on the Park's transformation shown in Fig. 1.

Manuscript received December 10, 2007. This paper was completed in Physics Department Faculty sciences at University of Boumerdes. This work was supported by the Minister of Higher Education and Scientific Research.

S. Grouni is with the Department of Physics, Faculty Sciences, and University of Boumerdes, Algeria; e-mail: sgrouni@yahoo.fr

R. Ibtouen is with the department of Electrical engineering, ENP, Algeria (e-mail: ribtiouen@yahoo.fr).

M. Kidouche is with the department of Automation, Boumerdes, Algeria (e-mail: kidouche_m@hotmail.com).

O. Touhami is with the department of Electrical Engineering, ENP, Algeria.

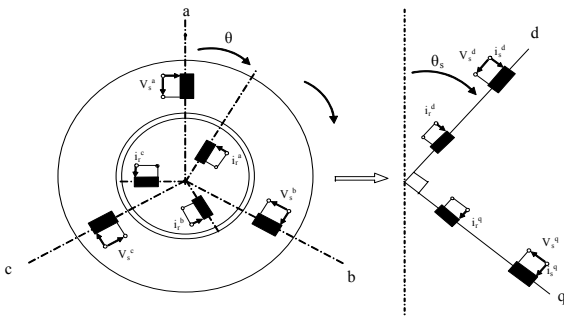

Fig. 1 Scheme of Park transformation for induction machines

The dynamic model of IM expressing the rotor flux and the stator currents in a reference frame rotating at synchronous speed ω_s is given by the following equations form [14].

$$\begin{cases} V_{ds} = R_s i_{ds} + \frac{d\phi_{ds}}{dt} - \omega_s \phi_{qs} \\ V_{qs} = R_s i_{qs} + \frac{d\phi_{qs}}{dt} + \omega_s \phi_{ds} \\ V_{dr} = R_r i_{dr} + \frac{d\phi_{dr}}{dt} - (\omega_s - \omega) \phi_{qr} = 0 \\ V_{qr} = R_r i_{qr} + \frac{d\phi_{qr}}{dt} + (\omega_s - \omega) \phi_{dr} = 0 \end{cases} \quad (1)$$

Electromagnetic torque and mechanical equations are given as follows:

$$C_{em} = p \frac{M_{sr}}{L_r} (\phi_{dr} i_{qs} - \phi_{qr} i_{ds}) \quad (2)$$

$$J \frac{d\Omega_r}{dt} + f_r \Omega_r = C_{em} - C_r \quad (3)$$

where (i_{ds}, i_{qs}) are the direct and quadrant axis components of stator currents, respectively the rotor flux (ϕ_{dr}, ϕ_{qr}) and rotor speed Ω_r are considered as state variables and the stator voltage (V_{ds}, V_{qs}) as command variables.

B. Indirect Field Oriented Control (IFOC)

IFOC method consists of using both the rotor flux amplitude and its angle which are calculated from the model of speed measurement and other accessible variables as the stator voltages or currents. In this method the torque C_{em}^* and flux ϕ_r^* are used as control references and the two stator currents (i_{ds}, i_{qs}) as command variables [12],[13].

$$\begin{cases} i_{qs}^* = \frac{L_r C_{em}^*}{p L_m \phi_r^*} \\ i_{ds}^* = \frac{1}{L_m} (T_r \frac{d\phi_r^*}{dt} + \phi_r^*) \\ \omega_{gl}^* = \frac{L_m i_{qs}^*}{T_r \phi_r^*} \text{ avec } \omega_s^* = \omega + \omega_{gl}^* \\ V_{ds}^* = R_s i_{ds}^* - \omega_s^* L_s i_{qs}^* \\ V_{qs}^* = R_s i_{qs}^* + \omega_s^* L_s i_{ds}^* \end{cases} \quad (4)$$

The mathematical model of oriented rotor flux represented by system (4) can be applied with Pulse Width Modulation (PWM) voltage or current control inverter. From system (4), we deduct two block diagrams of the oriented flux with voltage (Fig. 2) or currents (Fig. 3) inverter. The schematic block diagram of real control system is composed of a rectifier bridge followed by a low passive filter and PWM voltage or current inverter. The generation input logical signals PWM for the switching frequency inverter depends on the modulation strategies [1], [4], [10].

The following models controls are used on a closed loop IFOC system and which depend on the loading conditions.

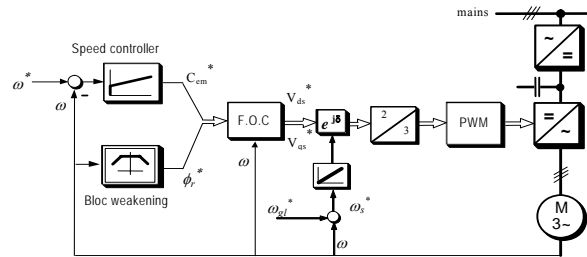

Fig. 2 Block scheme of IFOC on voltage control inverter

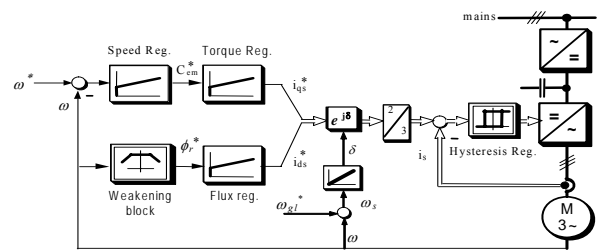

Fig. 3 Block scheme of IFOC on current control inverter

The current and voltage simulations controls of IFOC are given by Fig. 4 and Fig. 5.

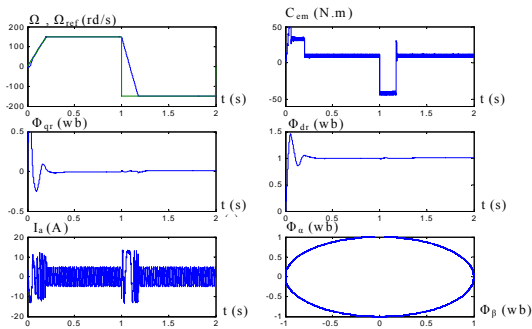

Fig. 4 Simulation of IFOC - IM drives with current control

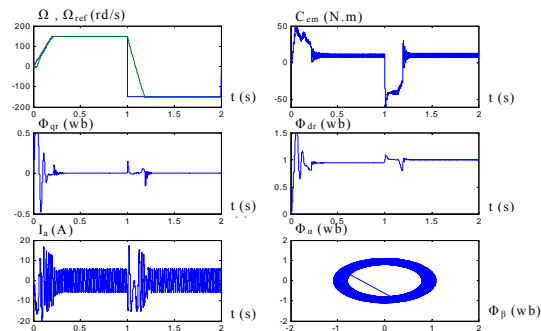

Fig. 5 Simulation of IFOC-IM drives with voltage control.

III. ROTOR TIME CONSTANT ADAPTATION

The influence on variation rotor time constant in IFOC is an important parameter for studying the dynamic response and robustness of the controller, particularly for the system stability. The adaptation parameters method is proposed in low load.

A. Variation Effect of Rotor Time Constant

Several research tasks [5],[7],[9],[10],[11] showed that the performances of the control with oriented flux depend strongly on the accuracy with which the parameters of the motor are known exactly. Thus, for rated values of the command currents. The simulation of mathematical equations given by (5) and (6) are plotted in Fig. 6.

$$\frac{C_{em}}{C_{em}^*} = \frac{T_r}{T_r^*} \frac{1 + \left(\frac{i_{qs}^*}{i_{ds}^*}\right)^2}{1 + \left[\left(\frac{T_r}{T_r^*}\right) \left(\frac{i_{qs}^*}{i_{ds}^*}\right)\right]^2} \quad (5)$$

$$\frac{\phi_r}{\phi_r^*} = \frac{\sqrt{1 + \left(\frac{i_{qs}^*}{i_{ds}^*}\right)^2}}{\sqrt{1 + \left[\left(\frac{T_r}{T_r^*}\right) \left(\frac{i_{qs}^*}{i_{ds}^*}\right)\right]^2}} \quad (6)$$

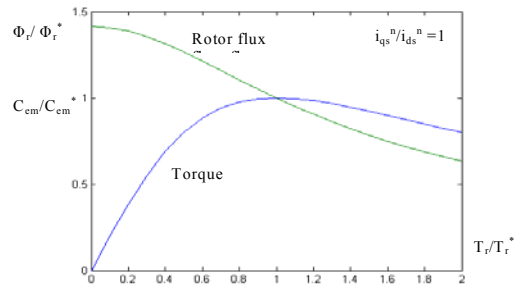

Fig. 6 Detuning of steady-state effect parameters for rate flux and torque currents command

These curves show that the actual value of the rotor time constant is smaller than the predicted value when $(T_r/T_r^* < 1)$. The identification method of rotor time constant is studied and simulated.

B. Rotor Time Constant Identification According to Garces Method

The simulation results given by Fig. 7 show the adaptation method according to Garces based on the comparison of two expressions of the machine reactive power. The simulation results applied for the light load [15], [16].

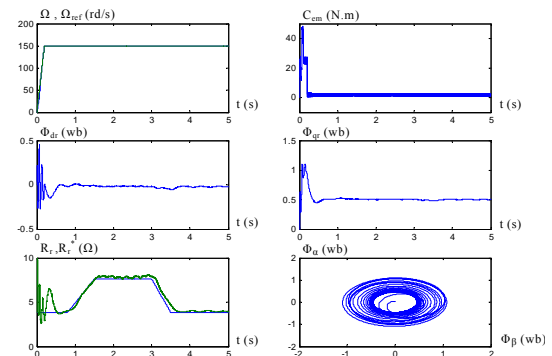

Fig. 7 Simulation of adaptation rotor time constant for $C_r=2$ N.m

C. Improved Approach Adaptation on Rotor Time-Constant

Our adaptation approach on rotor time constant is based on error signal of real and optimum rotors flux. This approach uses the optimization rotor flux of optimal control trajectory tracking. It's depends largely on the induction machine parameters. The flux optimizations function of copper loss minimization is given by:

$$\phi_r = f(C_{em}) \quad (7)$$

The optimal control is calculated by using the following equations:

$$u_1^o = \frac{L_r}{R_r M_{sr}} (\dot{\phi}_r^o + \frac{R_r}{L_r} \phi_r^o) \quad (8)$$

$$u_2^o = \frac{L_r}{p M_{sr}} \frac{C_{em}^*(t)}{\phi_r^o} \quad (9)$$

Developing this expression, and calculating the optimal flux according to the torque, the following expression is obtained:

$$\phi_r^{opt} = \beta \sqrt{C_{em}} \quad (10)$$

$$\beta = \left(\frac{\beta_2}{\beta_1} \right)^{1/4} \quad (11)$$

where β_1 and β_2 are functions which depends of IM parameters.

The direct axis component of rotor flux Φ_{dr} is used to identify the rotor resistance and the slip frequency is calculated from the error signal of rotor flux. In steady state the expression of direct component axis of rotor flux is defined:

$$\phi_{dr} = \frac{V_{qs} - R_s i_{qs}}{\omega_s} \quad (12)$$

$$\phi_{dr} = \phi_{ds} - X_{lsr} i_{ds} \quad (13)$$

$X_{lsr} = \sigma L_s$ is the linkage inductance

The estimated signal (S) is defined as follow:

$$S = \phi_{dr} = \frac{V_{qs} - R_s i_{qs}}{\omega_s} - X_{lsr} i_{ds} \quad (14)$$

The estimator of frequency leads to calculate the reference rotor time constant as output signal.

The reference signal is defined as follows:

$$S^* = \phi_{dr}^* = \phi_{dr}^{opt} \quad (15)$$

For estimated the stator resistance we used the follow equation:

$$R_s = \frac{V_{ds} + \omega_s \phi_{qs}}{i_{ds}} \quad (16)$$

The stator and rotor fluxes in quadrate axis are given by:

$$\phi_{qs} = \phi_{qr} + \sigma L_s i_{qs} \quad (17)$$

$$\phi_{qr} = L_m (i_{qr} + i_{qs}) \quad (18)$$

The q-axis stator flux is expressed by:

$$\phi_{qs} = X_{lsr} i_{qs} + L_m (i_{qr} + i_{qs}) \quad (19)$$

In IFOC control the current i_{qr} is written as:

$$i_{qr} = -\frac{L_m}{L_r} i_{qs} \quad (20)$$

Based on the calculated value of stator flux, we get the estimated stator resistance expression:

$$R_s = \frac{V_{ds} + \omega_s i_{qs} (\sigma L_s + L_m) + L_m i_{qr}}{i_{ds}} \quad (21)$$

To improve the rotor time constant with optimum flux we propose the ached block scheme diagram shown in Fig. 8:

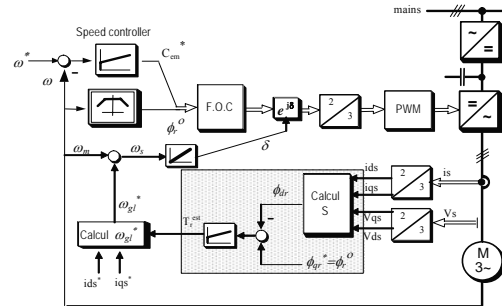

Fig. 8 Improvement approach adaptation diagram

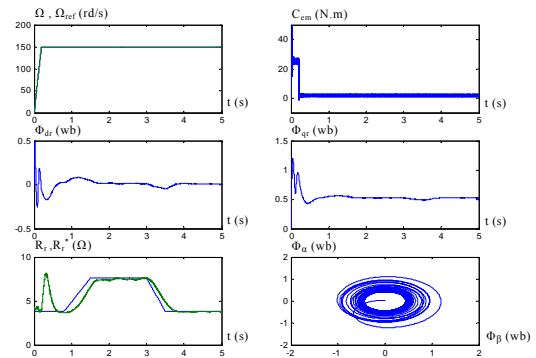

Fig. 9 Improvement simulation of adaptation approach for Cr=2 N.m

The simulation results in Fig. 9 display the desired behavior, with regard to the quality of the response obtained; this shows the utility and the validity of the proposed approach for the low loads.

IV. CONCLUSION

In this work, we have presented the harmful effect of rotor time constant variation in IM drives. This novel approach has successfully demonstrated the design of IFOC technique with rotor time constant variation for speed and torque controls IM. The Garces method is simulated and applied for low load. One of the advantages of our approach adaptation method on rotor time constant in IFOC is that, it can be applied for IM drives, and solves the thermal variation problem of rotor circuit. This method estimate and tune the rotor time constant from the initial to the actual value. Now, it is possible to conclude that, this approach can be applied to reduce losses in low load applications IM drives systems.

LIST OF SYMBOLS

In the paper following list of symbols have been used:

ω, ω_s : mechanical, electrical shaft speed
 Ω_r : mechanical rotor speed
 p : number of pole pairs in the motor
 R_s, R_r : stator, rotor resistances
 L_s, L_r : stator, rotor self-inductances
 M_{sr}, L_m : mutual self-inductance
 σ : total leakage coefficient
 f_r : viscous friction coefficient
 σL_s : leakage stator inductance ($=L_s - L_m^2 / L_r$)
 Φ_{ds}, Φ_{qs} : instantaneous stator flux in d-q frame
 Φ_{dr}, Φ_{qr} : instantaneous rotor flux in d-q frame
 J : rotor inertia of motor
 V_{ds}, V_{qs} : instantaneous stator voltages fixed d-q frame
 i_{ds}, i_{qs} : instantaneous stator currents fixed d-q frame
 V_{dr}, V_{qr} : instantaneous rotor voltages fixed d-q frame
 i_{dr}, i_{qr} : instantaneous rotor currents fixed d-q frame
 C_{em} : electromagnetic torque
 C_r : load torque
 C_{em}^* : reference electromagnetic torque
 ω_{gl} : slip frequency
 ω_{gl}^* : slip frequency reference command

APPENDIX

induction motor parameters: $P_n = 1.5$ kw,
 $U_n = 220$ v, $\Omega_n = 1420$ tr/mn, $I_n = 3.64$ A(Y) 6.31A(Δ),
 $R_s = 4.85\Omega$, $R_r = 3.805\Omega$, $L_s = 0.274$ H, $L_r = 0.274$ H, $p = 2$,
 $L_m = 0.258$ H, $J = 0.031$ kg.m², $f_r = 0.008$ Nm.s/rd.

REFERENCES

- [1] J. Holtz, "Sensorless control of Induction Machines- with or without Signal Injection?" Overview Paper, IEEE Trans. on Ind. Elect., Vol. 53, No.1, Feb. 2006, pp. 7-30.
- [2] K. Wang, J. Chiasson, M. Bodson, L. M. Tolbert, "An Online Rotor Time Constant Estimator for the Induction Machine," IEEE Trans. Contr. Syst. Technol., vol.15, No.2, pp. 339-347, March 2007.
- [3] R. Krishnan "Electric Motor Drives, Modeling, Analysis and control " 2001, Prentice Hall.
- [4] J. Holtz, J. Quan, "Sensorless control of induction motor drives" Proceedings of IEEE, Vol.(90), No.8, Aug. 2002,pp1359-1394.
- [5] S. H. Jeon, K.K. Oh, J.Y. Choi, "Flux observer with on line tuning of stator and rotor resistance for induction motors" IEEE Trans. Ind. Electron. Vol. 49, No.3, 2002, pp. 653-664.
- [6] A. El-Refaei, S. Mahmoud, R. Kennel, "Torque Ripple Minimization for Induction motor Drives with Direct Torque Control (DTC)" Electric Power Components & systems, vol. 33, No.8, Aug. 2005.
- [7] D. Novotny, R. Lorenz, "Introduction to field orientation and high performance AC" (2nd ed.), Ind. App. Society, IEEE, 1986, New York.
- [8] A.S. Bezanella, R. Reginetto, Robust tuning of the speed loop in Indirect field oriented control of induction motors, Journal Automatica Vol. (3), 2001, pp1811-1818.
- [9] A.S. Bezanella, R. Reginetto, "Robustness margins for Indirect field oriented control of induction motors" IEEE Trans. on Autom. Control Vol 45 (6), 2000, pp1226-1231.
- [10] J. Holtz, T. Thimm, "Identification of the machine parameters in a vector-controlled induction motor drive," IEEE Trans. on Industry Applications, 27 (6): 1991, pp1111-1118.
- [11] T. Matsuo, T. A. Lipo, "A rotor parameter identification scheme for vector-controlled induction motor drives," IEEE Trans. on Industry Applications, IA-21(4),1985, pp.624-632.
- [12] P. Vas, *Vector control of AC machines*.1990, Oxford Science Publications.

- [13] B.K. Bose, *Modern Power Electronics And AC Drives*. 2002, Prentice Hall.
- [14] P.Krause, "Analysis of electric Machinery, Series in Electrical Engineering" 1986, McGraw Hill, USA.
- [15] L. J. Garces, "Parameter adaptation for the speed-controlled static AC drive with a squirrel-cage induction motor," IEEE Trans. on Industry Applications, IA-16(2) 1980, pp.173-178.
- [16] T. Okuyama, H. Nagase, Y. Kubota, H. Horiuchi, K. Miyazaki, S. Ibori, " High performance AC speed control system using GTO converters" in Proc. IPEC'83 Tokyo, pp. 720-731.