

# Effect of Rotor to Casing Ratios with Different Rotor Vanes on Performance of Shaft Output of a Vane Type Novel Air Turbine

Bharat Raj Singh and Onkar Singh

**Abstract**—This paper deals with new concept of using compressed atmospheric air as a zero pollution power source for running motorbikes. The motorbike is equipped with an air turbine in place of an internal combustion engine, and transforms the energy of the compressed air into shaft work. The mathematical modeling and performance evaluation of a small capacity compressed air driven vane type novel air turbine is presented in this paper. The effect of isobaric admission and adiabatic expansion of high pressure air for different rotor to casing diameter ratios with respect to different vane angles (number of vanes) have been considered and analyzed. It is found that the shaft work output is optimum for some typical values of rotor / casing diameter ratios at a particular value of vane angle (no. of vanes). In this study, the maximum power is obtained as 4.5kW - 5.3kW (5.5-6.25 HP) when casing diameter is taken 100 mm, and rotor to casing diameter ratios are kept from 0.65 to 0.55. This value of output is sufficient to run motorbike.

**Keywords**—zero pollution, compressed air, air turbine, vane angle, rotor / casing diameter ratio

## I. INTRODUCTION

THE Marion King Hubbert [1] an US based geophysicist was the first man who applied effectively the principles of geology, physics and mathematics in 1956 and indicated that the conventional crude-oil production will attain Peak Oil in 1976 and thereafter it will start depleting which may cause serious threat to mankind within 40 years i.e. by 1995. The Worldwide faster consumptions of fossil fuel in transport vehicles have resulted fast depletion to energy resources and releasing huge quantities of pollutant in the atmosphere. Aleklett K. and Campbell C.J., [2] indicated in 2003 that with current rate of consumptions, the resources of oil and gas production will set to peak and begin to decline by around 2010. This apprehension necessitates the search for environment friendly alternative to fossil fuel oil, or some method of conserving natural resources using non-conventional options; such as bio-diesel, wind power, photo voltaic cells etc. and or energy conversion systems like battery

Bharat Raj Singh is Professor and Head of Department-Mechanical Engineering, with SMS Institute of Technology, Kashimpur Beruha, Lucknow-227125, UP, INDIA (phone: +91-522-2238116; fax: +91-522-2237273; e-mail: brsinghko@yahoo.com).

Onkar Singh is Professor and Head of Department-Mechanical Engineering, with Harcourt Butler Technological Institute, Nawabganj, Kanpur-208002, UP, India. (e-mail: onkpar@rediffmail.com).

storage, hydrogen cell, compressed air etc to obtain shaft work for the engines of vehicles [3-9].

The important work in the area of compressed air engine has been done by French technologist Guy Negre [10] and also by an inventor of quasi turbine G. Saint Hilaire [11]. The highly compressed air can be stored in the energy storage systems up to 20 bar pressure within 15–20 minutes, and reused for running compressed air engines. In view of the attractive features like nearly zero pollution and air compression using non-conventional resources, the compressed air engine appears to be comparable technology in place of the other in vehicle markets.

Here the parametric analysis of a small capacity air turbine having vane type rotor has been carried out and presented for investigating the effect of rotor to casing diameter ratios with different vanes in rotor. Results obtained using the mathematical modeling are presented and analyzed here.

## II. VANE TYPE NOVEL AIR TURBINE

In this study a vane type air turbine having casing diameter 100 mm and rotor diameter 75 mm is proposed as shown in Fig. 1. The proposed air turbine is considered to work on the reverse working principle of vane type compressor. In this arrangement total shaft work is cumulative effect of isobaric admission of compressed air jet on vanes and the adiabatic expansion of high pressure air. In earlier study conducted by authors a prototype of air turbine was developed and its functionality was ensured [12]. A cylinder for the storage of compressed air with a capacity of storing air for the requirement of 30 minutes running at initial stage and maximum pressure of 20 bar is used as a source of compressed air. The compressed air storage cylinder is designed to produce constant pressure for the minimum variation of torque at low volumes of compressed air and attached with filter, regulator and lubricator. The clean air then admits into air turbine through inlet nozzle. Vanes of novel air turbine are placed under spring loading to maintain their regular contact with the casing wall to minimize leakage which is proposed as improvement over the currently available vane turbine. A study on high efficiency energy conversion system for liquid nitrogen [13], design and verification of airfoil and its tests, influence of tip speed ratios for small wind turbine and parabolic heat transfer and structural analysis were also carried out for conceptualizing

the energy conversion system and design of the air turbine [14-17]. Studies have shown feasibility of vane type novel air turbine [18-23].

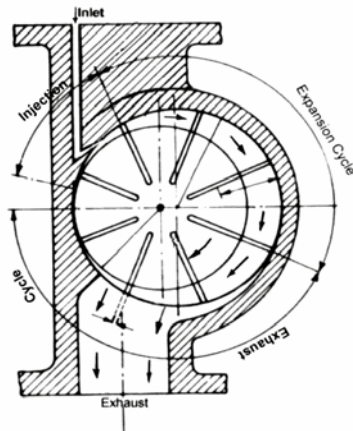

Fig. 1: Air Turbine- Model

The present objective is to investigate the performance of an air turbine with the variation of vanes in rotor, i.e. angle between first two consecutive vanes. The air turbine considered has capability to yield output of 5.25 to 6.50 HP at 4-6 bar air pressure for speed of 2000–2500 rpm, which is suitable for a motorbike.

### III. MATHEMATICAL MODELING

The mathematical model shown here is already presented in earlier publications [24-28] and is reproduced here for maintaining the continuity and benefits to the readers. The high pressure jet of air at ambient temperature drives the rotor in novel air turbine due to both isobaric admission and adiabatic expansion. Such high pressure air when enters through the inlet passage, pushes the vane for producing rotational movement through this vane and thereafter air so collected between two consecutive vanes of the rotor is gradually expanded up to exit passage. This isobaric admission and adiabatic expansion of high pressure air both contribute in producing the shaft work from air turbine. Compressed air leaving the air turbine after expansion is sent out from the exit passage. It is assumed that the scavenging of the rotor is perfect and the work involved in recompression of the residual air is absent as seen from Fig. 1.

From Fig. 2, it is seen that work output is due to isobaric admission (E to 1), and adiabatic expansion (1 to 4) and reference 2, 3 in the figure shows the intermediate position of vanes. Thus, total work output due to thermodynamic process may be written as:

Total work output = [Thermodynamic expansion work ( $w_1$ )]  
 + [Exit steady flow work ( $w_2$ )]

$$\text{or } w = [(w_1) + (w_2)] \quad (1)$$

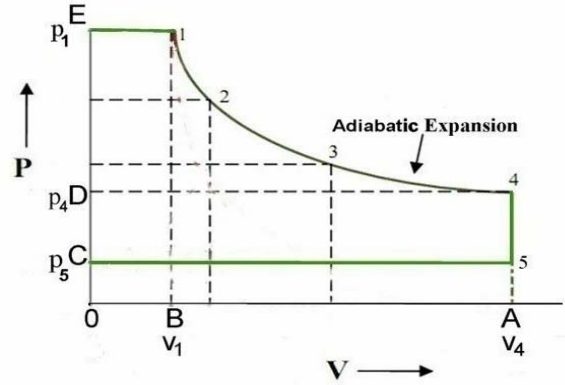

Fig. 2: Thermodynamic Processes (Isobaric, adiabatic and Isochoric Expansion)

Now thermodynamic expansion work ( $w_1$ ), considering adiabatic process between state 1 and 4, it can be written as:

$$w_1 = \left( \frac{\gamma}{\gamma - 1} \right) \cdot p_1 \cdot v_1 \cdot \left\{ 1 - \left( \frac{p_4}{p_1} \right)^{\frac{\gamma - 1}{\gamma}} \right\} \quad (2)$$

The process of exit flow (4-5) takes place after the expansion process (E- 4) as shown in Fig. 2 and air is released to the atmosphere. In this process; till no over expansion takes place pressure  $p_4$  can't fall below atmospheric pressure  $p_5$ . Thus at constant volume when pressure  $p_4$  drops to exit pressure  $p_5$ , no physical work is seen. Since turbine is functioning as positive displacement machine and hence under steady fluid flow at the exit of the turbine, the potential work is absorbed by the rotor and flow work ( $w_2$ ), can be written as:

$$w_2 = \int_4^5 v \cdot dp = v_4 (p_4 - p_5) \quad (3)$$

Applying equations (2), (3) into equation (1), considering air turbine has  $n$  number of vanes, then shaft output [29] can be written as:

$$w_n = n \cdot \left( \frac{\gamma}{\gamma - 1} \right) \cdot p_1 \cdot v_1 \cdot \left\{ 1 - \left( \frac{p_4}{p_1} \right)^{\frac{\gamma - 1}{\gamma}} \right\} + n \cdot (p_4 - p_5) \cdot v_4 \quad (4)$$

where  $w_n$  is work output (in Nm), for complete *one cycle*.

Therefore, the total power output or work done per unit time ( $W$ ), for speed of rotation  $N$  rpm, will be:

$$W_{total} = n \cdot (N/60) \cdot \left( \frac{\gamma}{\gamma - 1} \right) \cdot p_1 \cdot v_1 \cdot \left\{ 1 - \left( \frac{p_4}{p_1} \right)^{\frac{\gamma - 1}{\gamma}} \right\} + n \cdot (N/60) \cdot (p_4 - p_5) \cdot v_4 \quad (5)$$

Fig. 1 shows that if vanes are at angular spacing of  $\theta$  degree, then total number of vanes will be  $n = (360/\theta)$ . The variation in volume during expansion from inlet to exit (i.e.  $v_1$  to  $v_4$ ) can be derived by the variable extended length of vane as shown

in Fig. 3 at every point of movement between two consecutive vanes.

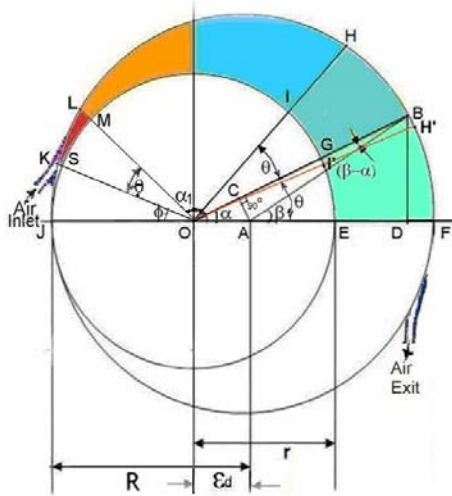

Fig. 3: Variable length BG and IH and injection angle  $\phi$

From Fig. 3, shows that when two consecutive vanes at OK and OL move to position OH and OB, the extended vane lengths varies from SK to IH and LM to BG, thus the variable length BG at variable  $\alpha_i$  is assumed as  $X_{at\ 'variable'\ \alpha}$  can be written from the geometry:

$$BG = X_{at\ 'variable'\ \alpha} = R \cos \left[ \sin^{-1} \left\{ \left( \frac{R-r}{R} \right) \sin \alpha \right\} \right] + (R-r) \cos \alpha - r \quad (6)$$

where  $2R=D$  is diameter of casing and  $2r=d$  is diameter of rotor,  $\alpha$  is angle  $\angle BOF$ ,  $\beta$  is angle  $\angle BAF$  and  $\theta$  is angle  $\angle HOB$  or  $\angle H'OF$  or  $\angle KOL$ , between two consecutive vanes and  $\phi$  is angle  $\angle KOJ$  at which injection pressure admits to the air turbine.

Variable volume of cuboids B-G-I-H-B can be written as:

$$v_{cuboids} = L \cdot \left\{ \frac{(X_{1i} + X_{2i})(2r + X_{1i})}{4} \right\} \cdot \sin \theta \quad (7)$$

where  $BG = X_{1i}$  and  $IH = X_{2i}$  variable length of vanes when rotate into turbine as shown in Fig. 3 and i stands for min or max length. Thus

a) The volume at inlet  $v_1$  or  $v_{min}$  will fall between angle  $\angle LOF = \alpha_{1min} = (180 - \theta - \phi)$  and angle  $\angle KOF = \alpha_{2min} = (\alpha_{1min} + \theta) = (180 - \phi)$  as seen in Fig. 3, when air is admits into turbine at angle  $\phi$ .

b) The Volume at exit  $v_4$  or  $v_{max}$  will fall between angle  $\angle BOF$   $\alpha_{1max} = \alpha = 0$  and angle  $\angle HOF$   $\alpha_{2max} = (\alpha_{1max} + \theta) = \theta$

Applying above conditions into equations (6), then  $LM = X_{1min}$ ,  $SK = X_{2min}$ ,  $FE = X_{1max} =$  Corresponding to BG at  $\alpha = 0$  degree and  $I'H' = X_{2max} =$  Corresponding IH at  $(\alpha + \theta) = \theta$  degree

Applying values of  $X_{1min}$  and  $X_{2min}$  to equation (7),

$$v_{min} = v_1 = L \cdot \left\{ \frac{(X_{1min} + X_{2min})(2r + X_{1min})}{4} \right\} \cdot \sin \theta \quad (8)$$

Applying values of  $X_{1max}$  and  $X_{2max}$  to equation (7),

$$v_{max} = v_4 = L \cdot \left\{ \frac{(X_{1max} + X_{2max})(2r + X_{1max})}{4} \right\} \cdot \sin \theta \quad (9)$$

Applying values of  $v_1$  and  $v_4$  from equations (8) and (9) to equation (5), the total power output available  $W_{total}$  can be written as:

$$W_{tot} = n(N/60) \left( \frac{\gamma}{\gamma-1} \right) \left\{ 1 - \left( \frac{p_4}{p_1} \right)^{\frac{\gamma-1}{\gamma}} \right\} p_1 \left[ L \left\{ \frac{(X_{1min} + X_{2min})(2r + X_{1min})}{4} \right\} \cdot \sin \theta \right] + n(N/60) (p_4 - p_5) \cdot \left[ L \left\{ \frac{(X_{1max} + X_{2max})(2r + X_{1max})}{4} \right\} \cdot \sin \theta \right] \quad (10)$$

#### IV. PARAMETRIC CONSIDERATIONS AND ANALYSIS

Detailed analysis of varying injection angles was carried out in earlier publication for expansion work, flow work, percentage contribution of expansion and flow work and total works at different injection pressure 2- 6 bar and different speed of rotation 500-2500 rpm. The contribution of expansion work becomes maximum when injection angle of air turbine is kept at  $60^\circ$ , at injection pressure 6 bar and speed of rotation 2500 rpm.

TABLE 1  
 INPUT PARAMETERS

Symbols	Parameters
(d/D) ratio	0.95, 0.9, 0.85, 0.80, 0.75, 0.70, 0.65, 0.60 and 0.55 when casing diameter is kept D=100 mm
$p_1$	6 bar ( $\approx 90$ psi) – inlet pressures
$p_5$	$(p_4 / 1.2) > 1.0132$ bar (atmospheric pressure)
$p_4$	$(v_1 / v_4)^\gamma \cdot p_1 > p_5$ assuming adiabatic expansion
$N$	2500 rpm (as total power is directly proportion to rpm)
$L$	45 mm length of rotor (assumed minimum)
$\gamma$	1.4 for air
$n$	Number of vanes in the rotor = $(\theta / 360)$
$\theta$	Vane angle = $30^\circ$ (12 vanes), $36^\circ$ (10 vanes), $45^\circ$ (8 vanes), $60^\circ$ (6 vanes), and $90^\circ$ (4 vanes)
$\phi$	$60^\circ$ angle at which compressed air enters through nozzle into rotor

In this study various input parameters are listed in Table 1 for investigation of performance of vane turbine at different rotor to casing diameter ratios ( $d/D$ ) with respect to different vane angle when  $D=100$  mm, injection pressure 6 bar (90 psi) and its optimization for larger shaft output.

### V. RESULTS AND DISCUSSION

Based on the various input parameters listed in Table-1 and mathematical model, the effects of different rotor to casing diameters ratios, at different vane angles, 2500 rpm of speed of rotation and 6 bar of injection pressure on the expansion work, exit flow work and total work output from air turbine are studied. Here the injection angle ( $\phi$ ) of the air turbine is considered to be constant at  $60^\circ$  for whole study.

The results obtained have been plotted in Figures 4 to 9, for the rotor to casing diameter ratio ( $d/D$ ), varied as 0.95, 0.90, 0.85, 0.80, 0.75, 0.70, 0.65, 0.60 and 0.55 at different vanes of rotor 12, 10, 8, 6, 4 (i.e. corresponding vanes angles of  $30^\circ$ ,  $36^\circ$ ,  $45^\circ$ ,  $60^\circ$ ,  $90^\circ$ ) and injection angle of  $60^\circ$  at injection pressures of 90 psi (6 bar) and at the speed of rotation 2500 rpm.

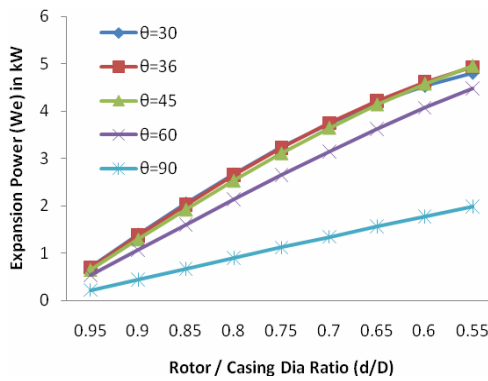

Fig. 4 Expansion power versus rotor / casing diameter ( $d/D$ ) ratio at different rotor vanes when  $D=100$  mm, injection pressure = 6 bar and speed of rotation =2500 rpm

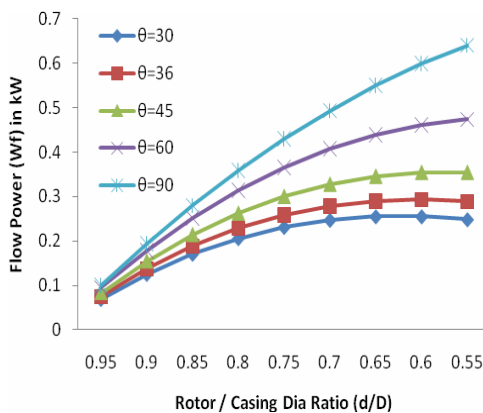

Fig. 5 Exit flow power versus rotor / casing diameter ( $d/D$ ) ratio at different vane number (vane angles) when  $D=100$  mm, injection pressure = 6 bar and speed of rotation =2500 rpm

Fig. 4 shows the variation of expansion power for the rotor vanes =12 nos. ( $\theta=30^\circ$ ), 10 nos. ( $\theta=36^\circ$ ), 8 nos. ( $\theta=45^\circ$ ), are increasing linearly at rotor / casing ratios =0.95, 0.90, 0.85, 0.80, 0.75 to 0.70 and it almost varies in similar values. Thereafter at rotor / casing ratios=0.65, 0.60 and 0.55 it increases parabolically and varies differently. Thus optimal performance of expansion power is seen at rotor / casing ratios =0.70 for vanes number 12 to 8. But variation of expansion power for the rotor vanes =6 nos. ( $\theta=60^\circ$ ), and 4 nos. ( $\theta=90^\circ$ ), are increasing linearly at rotor / casing ratios =0.95 to 0.55 and it is of smaller value.

Fig. 5 shows the variation of flow power for the rotor vanes =12 nos. ( $\theta=30^\circ$ ), 10 nos. ( $\theta=36^\circ$ ), and 8 nos. ( $\theta=45^\circ$ ), 6 nos. ( $\theta=60^\circ$ ), and 4 nos. ( $\theta=90^\circ$ ), are increasing parabolically at rotor / casing ratios =0.95 to 0.55 and it almost varies with different power values. It is also noticed that for the rotor vanes 6 nos. ( $\theta=60^\circ$ ), and 4 nos. ( $\theta=90^\circ$ ) the values of power are found large.

Fig. 6 shows the percentage contribution of expansion power for different rotor / casing ratios =0.95 to 0.55 at the rotor vanes =12 nos. ( $\theta=30^\circ$ ), 10 nos. ( $\theta=36^\circ$ ), and 8 nos. ( $\theta=45^\circ$ ), are increasing from 87% to 95% and at the rotor 6 nos. ( $\theta=60^\circ$ ), and 4 nos. ( $\theta=90^\circ$ ), it varies from 85% to 90% and from 70% to 78% respectively.

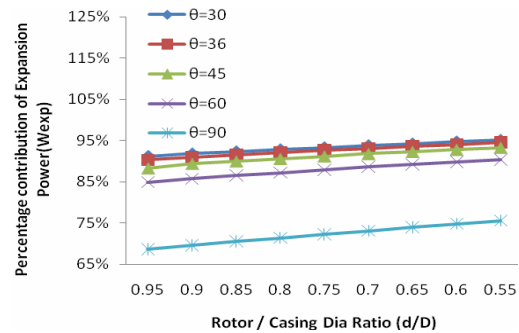

Fig. 6 Percentage contribution of expansion power versus rotor / casing diameter ( $d/D$ ) ratio at different vane number (vane angles) when  $D=100$  mm, injection pressure = 6 bar and speed of rotation =2500 rpm

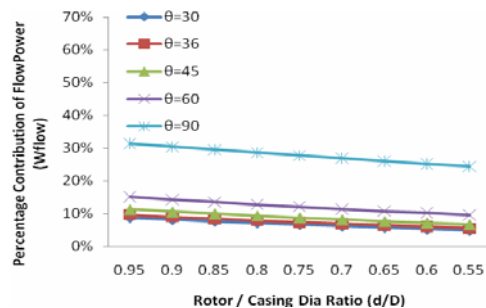

Fig. 7 Percentage contribution of exit flow power versus rotor / casing diameter ( $d/D$ ) ratio at different vane number (vane angles) when  $D=100$  mm, injection pressure = 6 bar and speed of rotation =2500 rpm

Fig. 7 shows the contribution of flow power for different rotor / casing ratios =0.95 to 0.55 at the rotor vanes =12 nos. ( $\theta=30^\circ$ ), 10 nos. ( $\theta=36^\circ$ ), and 8 nos. ( $\theta=45^\circ$ ) are decreasing from 13% to 5% and at the rotor 6 nos. ( $\theta=60^\circ$ ), and 4 nos. ( $\theta=90^\circ$ ), it varies from 15% to 10% and from 30% to 22% respectively.

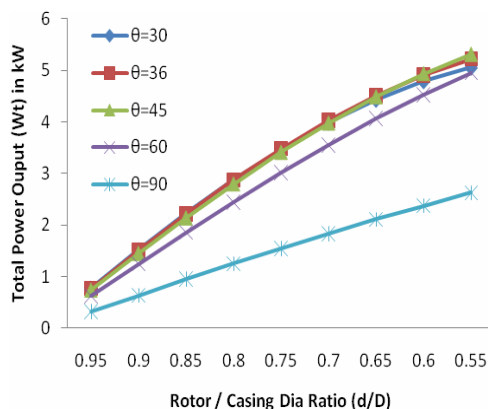

Fig. 8 Total Power Output vs. Vane Number (Vane angles) at different Injection angle when Injection pressure = 6 bar and speed of rotation =2500 rpm

Variation of total power output with respect to different vane angle = $30^\circ$  (12 vanes),  $36^\circ$  (10 vanes),  $45^\circ$  (8 vanes),  $60^\circ$  (6 vanes) and  $90^\circ$  (4 vanes) are increasing linearly at rotor / casing ratios =0.95, 0.90, 0.85, 0.80, 0.75 to 0.70 and it almost varies in similar values as seen in Fig.8. Thereafter at rotor / casing ratios=0.65, 0.60 and 0.55 it increases parabolically and varies differently. Thus optimal performance of total power is found between 4.51 kW to 5.3 kW at rotor / casing ratios =0.65 to 0.55 for the rotor vanes 12 to 8 whereas total power is found increasing linearly for the rotor vanes =6 nos. ( $\theta=60^\circ$ ), and 4 nos. ( $\theta=90^\circ$ ), at rotor / casing ratios =0.95 to 0.55 and it is of smaller value.

Although the total shaft power output is combined effect of the component of expansion power and exit flow power, but contribution of expansion power is found predominant. The contribution of exit flow power varies from 15.0% to 0.5% at injection pressure of 6 bar and speed of rotation at 2500 rpm. Thus it is obvious that the expansion power output as well as total power output is found optimum when vane angle ranges from  $30^\circ$ - $45^\circ$  (12-8 vane nos.), injection angle at  $60^\circ$  or above, rotor/casing diameter ratio lie between 0.65 to 0.60, speed of rotation at 2500 rpm and injection pressure at 6 bar.

## VI. CONCLUSION

Based on input parameters and the results of the above investigations, following conclusions are drawn:

- There exists an optimal value of rotor/casing diameter ratio (approx. 0.65 to 0.55) for the considered air turbine for vane nos. 8 (vane angle  $45^\circ$ ). This optimal value of rotor/casing diameter ratio offers the maximum expansion power from 4.3 kW to 4.71 kW at injection air pressures 6 bar.

- The exit flow power due to steady flow is seen to be maximum and increasing from 0.24 kW to 0.64 kW at rotor / casing ratio 0.55.
- Total power output of air turbine is seen to be maximum for the higher injection air pressure and there exists an optimum value of rotor/casing diameter ratio for injection pressure 6 bar, speed of rotation 2500 rpm and at particular vane angles as shown below:
  - when rotor to casing diameter ratios are 0.65 to 0.55, and vane nos. 8 (vane angle  $45^\circ$ ), the optimal total power ranges from 4.5 kW to 5.3 kW.
  - when rotor to casing diameter ratios are of 0.75-0.70 and vanes nos. 10(vane angle  $36^\circ$ ), the optimal total power ranges from 3.5 kW-4.0 kW and
  - when rotor to casing diameter ratios are of 0.95-0.80 and vanes nos. 12 (vane angle  $30^\circ$ ), the optimal total power ranges from 0.78 kW-2.87 kW.

Thus optimum shaft power output of a novel vanned type air turbine is obtained when the design parameters for rotor diameter to casing diameter (d/D) ratios are kept between 0.65 to 0.55 and vanes nos. 8 (vane angle is of  $45^\circ$ ).

## NOMENCLATURE

$d$	diameter of rotor (2r) in meter
$D$	diameter of outer (2R) cylinder in meter
$L$	length of rotor having vanes in meter
$n$	no. of vanes=(360/ $\theta$ )
$N$	no. of revolution per minute
$P$	pressure in bar
$p_1, v_1$	pressure and volume respectively at which air strike the Turbine,
$p_4, v_4$	pressure and volume respectively at which maximum expansion of air takes place,
$p_5$	pressure at which turbine releases the air to atmosphere.
$v$	volume in cu-m
$w$	theoretical work output in Nm
$W$	theoretical power output (Nm/s)
$X_{li}$	variable extended lengths of vane at point 1
$X_{2i}$	variable extended lengths of vane at point 2
bar	(1 / 1.0132) atmospheric pressure

## Subscripts

$1, 2, \dots, 4, 5$	subscripts – indicates the positions of vanes in casing
e, exp	expansion
f, flow	flow
t, total	total
min	minimum
max	maximum

Greek symbols

$\alpha$	angle BOF
$\alpha_1$	angle LOF(=180- $\phi$ )
$\alpha_2$	angle KOF(=180- $\theta$ - $\phi$ )
$\beta$	angle BAF
$\gamma$	1.4 for air
$\theta$	angle between 2-vanes (BOH)
$\phi$	angle at which compressed air enters into rotor through nozzle
$\xi_d$	eccentricity ( $R-r$ )

REFERENCES

- [1] Hubbert M.K., 1956, Nuclear energy and the fossil fuels; Amer. Petrol. Inst. Drilling and Production Practice, *Proc. Spring Meeting*, San Antonio, Texas. 7-25(187).
- [2] Aleklett K. and Campbell C.J., 2003, The Peak and Decline of World Oil and Gas Production- *Minerals and Energy, Raw Materials Report*, Volume 18, Number 1, 2003, pp. 5-20(16).
- [3] Singh B.R. and Singh Onkar, 2007, Use of Non-Conventional Energy for Sustainability to Fossil Fuel, *National Conference on Recent Trend on Mechanical Engineering, RAME-2007*, held on 28-29th March'2007 at Baba Sahab Dr. Bhim Rao Ambedkar College of Agricultural Engineering and Technology, Etawah-Proceedings pp 130-136.
- [4] Singh B.R. and Singh Onkar, 2007, Uses of Wind Power as a Non-Conventional / Renewable Energy for Sustainability, *National Conference on State of Art Technology in Mechanical Engineering, STEM-2007*, held on October 29-31, 2007 at College of Technology, G.B. Pant University, Pant Nagar, UP-Proceedings pp 503-515.
- [5] Honton E. J., 2004, Hydrogen Fuel Cell Car, presented at *15th Annual US Conference and Hydrogen Expo*, April'2004, USA.
- [6] Rose Robert and William J. Vincent, 2004, Fuel Cell Vehicle World Survey 2003, *Breakthrough Technologies Institute*, February' 2004, Washington, D.C.
- [7] Singh B.R. and Singh Onkar, 2006, Necessity and Potential for Bio-Diesel Use in India, *International Conference on Bio-Fuel Vision-2015*, October'13th -15th, 2006 at Bikaner, India- Proceedings pp 71-89.
- [8] Singh B.R. and Singh Onkar, 2006, Study of Compressed Air as an alternative to fossil fuel for Automobile Engines, *International Conference on Challenges and Strategies for Sustainable Energy and Environment*- held on 10-11th June'2006 at UPTU, Lucknow, UP-Proceedings pp 179-191.
- [9] Singh B.R. and Singh Onkar, 2008, A Study on Sustainable Energy Sources and its Conversion Systems towards Development of an Efficient Zero Pollution Novel Turbine to be used as Prime-mover to the Light Vehicle, *2008 ASME International Mechanical Engineering Congress and Exposition*, held on October 31-November 6, 2008 at Boston, Massachusetts, USA- Paper No. IMECE -2008 -66803.
- [10] Negre Guy and Negre Cyril, 2004, Compressed Air - The Most Sustainable Energy Carrier for Community Vehicles, Speech in front of assembly at Kultur gathered for *Fuel Cells World*, Tuesday 29th June '2004.
- [11] Saint Hilaire G., Saint Hilaire R. and Saint Hilaire, Y., 2005, Quasiturbine zero pollution car using gasoline. *Festival at Le Lundi, Montreal Gazette*, 26 September 2005.
- [12] Singh B.R. and Singh Onkar, 2008, Development of a vaned type novel Air Turbine, *International Journal of Mechanical Engineering Science* (The manuscript was received on 21<sup>st</sup> December 2007 and was accepted after revision for publication on 03<sup>rd</sup> June 2008), *International Journal of IMechE* Vol. 222 Part C, pp 1419-1426.
- [13] Knowlen C., Bruckner A. P., Mattick A.T. and Hertzberg A., 1998, High Efficiency Energy Conversion Systems for Liquid Nitrogen Automobiles, *Society of Automotive Engineers, Inc., AIAA* 98-1898.
- [14] Fuglsang P., Bak C. and Gunna M., 2004, Design and verification of the Ris0-B1 Airfoil-family for Wind Turbines, *Journal of Solar Energy Engg.*, ASME- Nov'2004, Vol.126 pp 1002-1008.
- [15] Gorla R. and Reddy, S., 2005, Probabilistic Heat Transfer and Structural Analysis of Turbine Blade, *IJTJE*, Vol. 22, pp 1- 11.
- [16] Selig Michel S. and Bryan D. McGranahan, 2004, Wind Tunnel Aerodynamics Tests of Six Airfoils for use on Small Wind Turbines, *Journal of Solar Energy Engg.*, ASME-Nov'2004, Vol.126, pp986-1000.
- [17] Schreck S. and Robinson M., 2004, Tip Speed Ratio Influences on Rationally Augmented Boundary Layer Topology and Aerodynamic Force Generation, *Journal of Solar Energy Engg.*, ASME-Nov' 2004- Vol.126 pp1025-1033.
- [18] Singh B.R. and Singh Onkar, 2008, A concept for Development of a Vaned Type Novel Air Turbine, *12<sup>th</sup> International Symposium on Transport Phenomena and Dynamics of Rotating Machinery* - held on February 17-22, 2008 at Pacific Center of Thermal-Fluids Engineering, Sheraton Mohana Surfriider Hotel Honolulu, Hawaii - Paper No. ISROMAC-12-20046.
- [19] Singh B.R. and Singh Onkar, 2008, Energy Storage System to meet Challenges of 21<sup>st</sup> Century- an Overview, *All India Seminar on Energy Management in Perceptive of Indian Scenario*-held on October 17-19, 2008 at Institution of Engineer (India), State Centre, Engineer's Bhawan, Lucknow-Proceedings Chapter15, pp 157-167.
- [20] Singh B.R. and Singh Onkar, 2008, A Study to Optimize the Output of Vaned Type Novel Air Turbine, *4<sup>th</sup> International Conference on Energy Research and Development*, held on 17-19 November, 2008 at State of Kuwait, Kuwait- Paper No. ICERD - 4 -1353.
- [21] Singh B.R. and Singh Onkar, 2008, Parametric Evaluation of Vane Angle on performance of Novel Air Turbine, *Journal of Science, Engineering and Management, SITM*, December, 2008, Vol. 2, pp 7-18.
- [22] Singh B.R. and Singh Onkar, 2009, Analytical Study on a Vaned Type Novel Air Turbine for Different Conditions of Casing and Rotor Diameters, *2009 ASME International Conference on Energy Sustainability* - held on July 17-23, 2009, at San Francisco, California, USA, Paper No. ES -2009 -90207.
- [23] Singh B.R. and Singh Onkar, 2009, Applications of Compressed Air as an Alternative Energy to Meet Challenges of 21st Century- Global Warming, *International Conference on Engineering Congress on Alternatives Energy Applications: Option or Necessity?*, held on 3-5 November, 2009 at State of Kuwait, Kuwait- Paper No. EC2009 Kuwait-1082.
- [24] Singh B.R. and Singh Onkar, 2009, Numerical Analysis of Pressure Admission Angle to Vane Angle Ratios on Performance of a Vaned Type Novel Air Turbine, *International Journal of Natural Science and Engineering, IJNSE*, France, Vol. 1, Number-1(4), pp 20-27.
- [25] Singh B.R. and Singh Onkar, 2009, Theoretical Investigations on Different Casing and Rotor Diameters Ratio to Optimize Shaft Output of a Vaned Type Air Turbine, *International Journal of Natural Science and Engineering, IJNSE*, France, Vol. 1, Number-1(5), pp 28-35.
- [26] Singh B.R. and Singh Onkar, 2009, Parametric Evaluations of Injection Angles and Vane Angles on Performance of a Vaned Type Novel Air Turbine, *International Journal of Mathematical, Physical and Engineering Sciences, IJMPEs*, France, Vol. 3, Number-4(38), pp 226-233.
- [27] Singh B.R. and Singh Onkar, 2009, Analytical Investigations on Different Air Injection Angles to Optimize Power Output of a Vaned Type Air Turbine, *International Journal of Power and Energy* (The manuscript was received on 11<sup>th</sup> June' 2009 and was accepted after revision for publication on 07<sup>th</sup> October' 2009), *Proceedings of IMechE Part A*, (In press).
- [28] Singh B.R. and Singh Onkar, 2009, Optimization of Power Output of a Vaned Type Novel Air Turbine With Respect to Different Injection Angles-Under Ideal Adiabatic Expansion, *International Journal of Mechanical Engineering, Serials Publications, New Delhi, India*, Vol. 2 Number 2, July-December'2009, pp 205-211.
- [29] Singh Onkar, 2009, Reciprocating and Rotary Compressor, Applied Thermodynamics, *New Age International (P) Ltd., Publishers, New Delhi, India*, ISBN: 978-81-224-2583-3, Feb2009, pp 797-798.