

# Design of an Augmented Automatic Choosing Control by Lyapunov Functions Using Gradient Optimization Automatic Choosing Functions

Toshinori Nawata

*Abstract*—In this paper we consider a nonlinear feedback control called augmented automatic choosing control (AACC) using the gradient optimization automatic choosing functions for nonlinear systems. Constant terms which arise from sectionwise linearization of a given nonlinear system are treated as coefficients of a stable zero dynamics. Parameters included in the control are suboptimally selected by expanding a stable region in the sense of Lyapunov with the aid of the genetic algorithm. This approach is applied to a field excitation control problem of power system to demonstrate the splendishness of the AACC. Simulation results show that the new controller can improve performance remarkably well.

*Keywords*—augmented automatic choosing control, nonlinear control, genetic algorithm, zero dynamics.

## I. INTRODUCTION

GENERALLY, it is easy to design the optimal control laws for linear systems, but it is not so for nonlinear systems, though they have been studied for many years[1]~[8]. One of most popular and practical nonlinear control laws is synthesized by applying a linearization method by Taylor expansion truncated at the first order and the linear optimal control method. This is only effective in a small region around steady state points or in almost linear systems[1]~[3].

Another nonlinear control called an automatic choosing control (ACC) has been studied [6]. This controller is effective in nonlinear systems with high nonlinearity and wider regions. But constant terms, which generally appear in equations when linearized by Taylor expansion, lead the controller to have bias at the origin, so the resulting ACC must be modified by bothersome unbiased nonlinear functions in view of stability.

To overcome these weakness, in this paper we consider an augmented automatic choosing control (AACC) for nonlinear systems[7][8] and its design procedure is as follows.

Assume that a system is given by a nonlinear differential equation. Choose a separative variable, which makes up nonlinearity of the given system. The domain of the variable is divided into some subdomains. On each subdomain, the system equation is linearized by Taylor expansion around a suitable point so that a constant term is included in it. This constant term is treated as a coefficient of a stable zero dynamics. The given nonlinear system approximately makes up a set of augmented linear systems, to which the optimal linear control theory is applied to get the linear quadratic (LQ)

T. Nawata is with the Department of Human-Oriented Information Systems Engineering, Kumamoto National College of Technology, Koshi, Kumamoto, 861-1102 JAPAN e-mail: nawata@kumamoto-nct.ac.jp .

controls[2]. These LQ controls are smoothly united by gradient optimization automatic choosing functions to synthesize a single nonlinear feedback controller.

This controller is of a structure-specified type which has some parameters, such as the number of division of the domain, regions of the subdomains, points of Taylor expansion, and gradients of the automatic choosing function. These parameters must be selected optimally so as to be just the controller's fit. Since they lead to a nonlinear optimization problem, we are able to solve it by using the genetic algorithm (GA)[9] suboptimally. In this paper the suboptimal values of these parameters are selected by maximizing a stable region in the sense of Lyapunov.

This approach is applied to a field excitation control problem of power system, which is Ozeki-Power-Plant of Kyushu Electric Power Company in Japan, to demonstrate the splendishness of the AACC. Simulation results show that the new controller using the GA is able to improve performance remarkably well.

## II. AUGMENTED AUTOMATIC CHOOSING CONTROL USING ZERO DYNAMICS

Assume that a nonlinear system is given by

$$\dot{x} = f(x) + g(x)u, \quad x \in \mathbf{D} \quad (1)$$

where  $\dot{\cdot} = d/dt$ ,  $x = [x[1], \dots, x[n]]^T$  is an  $n$ -dimensional state vector,  $u = [u[1], \dots, u[r]]^T$  is an  $r$ -dimensional control vector,  $f: \mathbf{D} \rightarrow R^n$  is a nonlinear vector-valued function with  $f(0) = 0$  and is continuously differentiable,  $g(x)$  is an  $n \times r$  driving matrix with  $g(0) \neq 0$ ,  $\mathbf{D} \subset R^n$  is a domain, and  $T$  denotes transpose.

Considering the nonlinearity of  $f$ , introduce a vector-valued function  $C: \mathbf{D} \rightarrow R^L$  which defines the separative variables  $\{C_j(x)\}$ , where  $C = [C_1 \dots C_j \dots C_L]^T$  is continuously differentiable. Let  $D$  be a domain of  $C^{-1}$ . For example, if  $x[2]$  is the element which has the highest nonlinearity in  $f$ , then

$$C(x) = x[2] \in D \subset R \quad (L = 1)$$

(see Section IV). The domain  $D$  is divided into some subdomains:  $D = \cup_{i=0}^M D_i$ , where  $D_M = D - \cup_{i=0}^{M-1} D_i$  and  $C^{-1}(D_0) \ni 0$ .  $D_i (0 \leq i \leq M)$  endowed with a lexicographic order is the Cartesian product  $D_i = \prod_{j=1}^L [a_{ij}, b_{ij}]$ , where  $a_{ij} < b_{ij}$ .

Introduce a stable zero dynamics :

$$\dot{x}[n+1] = -\sigma_i x[n+1] \quad (2)$$

$$(x[n+1](0) \simeq 1, \quad 0 < \sigma_i < 1).$$

Eq.(1) combines with (2) to form an augmented system

$$\dot{\mathbf{X}} = \bar{f}(\mathbf{X}) + \bar{g}(\mathbf{X})u \quad (3)$$

where

$$\mathbf{X} = \begin{bmatrix} x \\ x[n+1] \end{bmatrix} \in \mathbf{D} \times R$$

$$\bar{f}(\mathbf{X}) = \begin{bmatrix} f(x) \\ -\sigma_i x[n+1] \end{bmatrix}, \bar{g}(\mathbf{X}) = \begin{bmatrix} g(x) \\ 0 \end{bmatrix}.$$

We assume a cost function being

$$J = \frac{1}{2} \int_0^\infty (\mathbf{X}^T \mathbf{Q} \mathbf{X} + u^T R u) dt \quad (4)$$

where  $\mathbf{Q} = \mathbf{Q}^T > 0$ ,  $R = R^T > 0$ , and the values of these matrices are properly determined based on engineering experience.

On each  $D_i$ , the nonlinear system is linearized by the Taylor expansion truncated at the first order about a point  $\hat{X}_i \in C^{-1}(D_i)$  and  $\hat{X}_0 = 0$  (see Fig. 1):

$$f(x) + g(x)u \simeq A_i x + w_i + B_i u \quad \text{on } C^{-1}(D_i) \quad (5)$$

where

$$A_i = \left. \frac{\partial f(x)}{\partial x} \right|_{x=\hat{X}_i}, w_i = f(\hat{X}_i) - A_i \hat{X}_i, \\ B_i = g(\hat{X}_i).$$

Make an approximation of (3) by

$$\dot{\mathbf{X}} = \bar{A}_i \mathbf{X} + \bar{B}_i u \quad \text{on } C^{-1}(D_i) \times R \quad (6)$$

where

$$\bar{A}_i = \begin{bmatrix} A_i & w_i \\ 0 & -\sigma_i \end{bmatrix}, \bar{B}_i = \begin{bmatrix} B_i \\ 0 \end{bmatrix}.$$

An application of the linear optimal control theory[2] to (4) and (6) yields

$$u_i(\mathbf{X}) = -R^{-1} \bar{B}_i^T \mathbf{P}_i \mathbf{X} \quad (7)$$

where the  $(n+1) \times (n+1)$  matrix  $\mathbf{P}_i$  satisfies the Riccati equation :

$$\mathbf{P}_i \bar{A}_i + \bar{A}_i^T \mathbf{P}_i + \mathbf{Q} - \mathbf{P}_i \bar{B}_i R^{-1} \bar{B}_i^T \mathbf{P}_i = 0. \quad (8)$$

Introduce a gradient optimization automatic choosing function :

$$I_i(x) = \prod_{j=1}^L \left\{ 1 - \frac{1}{1 + \exp(2N_{1i}(C_j(x) - a_{ij}))} \right. \\ \left. - \frac{1}{1 + \exp(-2N_{1i}(C_j(x) - b_{ij}))} \right\} \quad (9)$$

where  $N_{1i}$ : positive real value,  $-\infty \leq a_{ij}$ ,  $b_{ij} \leq \infty$ .  $I_i(x)$  is analytic and almost unity on  $C^{-1}(D_i)$ , otherwise almost zero(see Fig. 2).

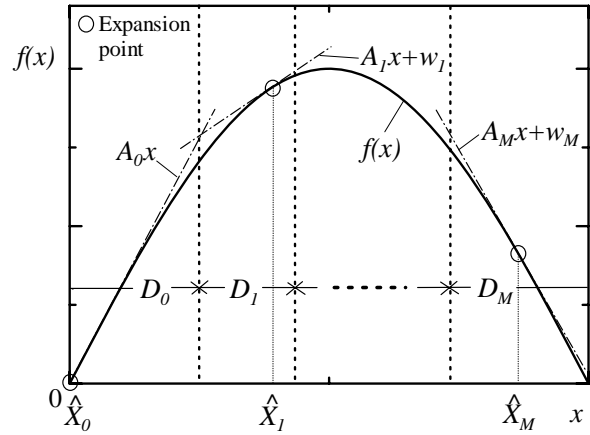

Fig. 1 Sectionwise linearization

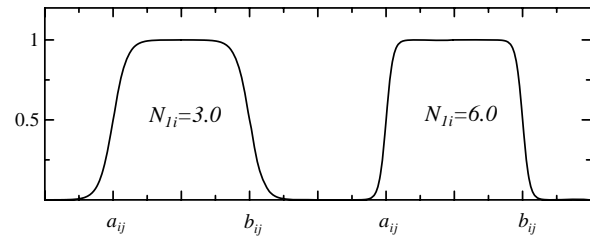

Fig. 2 Automatic Choosing Function( $N_{1i}=3.0, 6.0$ )

Uniting  $\{u_i(\mathbf{X})\}$  of (7) with  $\{I_i(x)\}$  of (9), we have an augmented automatic choosing control

$$u(\mathbf{X}) = \sum_{i=0}^M u_i(\mathbf{X}) I_i(x). \quad (10)$$

### III. PARAMETER SELECTION BY GA

Introduce a Lyapunov function candidate:

$$V(\mathbf{X}) = \mathbf{X}^T \Pi(\mathbf{X}) \mathbf{X} \quad (11)$$

where

$$\Pi(\mathbf{X}) = \sum_{i=0}^M \mathbf{P}_i \Pi_i(x), \\ \Pi_i(x) = \eta_i \prod_{j=1}^L \left\{ 1 - \frac{1}{1 + \exp(2N_2(C_j(x) - a_{ij}))} \right. \\ \left. - \frac{1}{1 + \exp(-2N_2(C_j(x) - b_{ij}))} \right\} \quad (12)$$

where  $\mathbf{P}_i$  satisfies the Riccati equation (8).  $N_2$  and  $\eta_i$  are positive real values. By the Lyapunov's direct method, the equilibrium point 0 is uniformly stable on a connected set:

$$\mathbf{D}_V = \{x \in \mathbf{D} : V(\mathbf{X}) < \gamma, \dot{V}(\mathbf{X}) < 0\}$$

where

$$\gamma = \inf \{V(\mathbf{X}) : \mathbf{X} \neq 0, \dot{V}(\mathbf{X}) = 0\}.$$

In order to make a stable region in the sense of Lyapunov as wide as possible, we define a performance

$$PI = -\gamma. \quad (13)$$

A set of parameters included in the control of Eq.(10) is

$$\tilde{\Omega} = \{M, N_{1i}, a_{ij}, b_{ij}, \hat{X}_i, \dots\} \quad (14)$$

which is suboptimally selected by minimizing  $PI$  with the aid of GA[9] as follows.

<ALGORITHM>

**step1:Apriori:** Set values  $\tilde{\Omega}_{apriori}$  appropriately.

**step2:Parameter:** Choose  $\Omega \subset \tilde{\Omega}$  to be improved and rewrite

$$\Omega = \{N_{1i}, a_i, b_i, \dots\} = \{\alpha_k : k = 1, \dots, K\}.$$

**step3:Coding:** Represent each  $\alpha_k$  with a binary bit string of  $\tilde{L}$  bits and then arrange them into one string of  $\tilde{L}K$  bits.

**step4:Initialization:** Randomly generate an initial population of  $\tilde{q}$  strings

$$\{\Omega_p : p = 1, \dots, \tilde{q}\}.$$

**step5:Decoding:** Decode each element  $\alpha_k$  of  $\Omega_p$  by

$$\alpha_k = (\alpha_{k,max} - \alpha_{k,min})A_k / (2^{\tilde{L}} - 1) + \alpha_{k,min}$$

where  $\alpha_{k,max}$ :maximum,  $\alpha_{k,min}$ :minimum, and  $A_k$ :decimal values of  $\alpha_k$ .

**step6:Lyapunov function:** Make  $\gamma = \gamma_p$  ( $p = 1, \dots, \tilde{q}$ ) for  $\Omega_p$  by using Eq.(11).

**step7:Fitness value calculation:** Calculate

$$PI_p = -\gamma_p$$

by Eq.(13), or fitness  $F_p = -PI_p$ .

**step8:Reproduction:** Reproduce each of individual strings with the probability of

$$F_p / \sum_{j=1}^{\tilde{q}} F_j.$$

**step9:Crossover:** Pick up two strings and exchange them at a crossing position by a crossover probability  $P_c$ .

**step10:Mutation:** Alter a bit of string (0 or 1) by a mutation probability  $P_m$ .

**step11:Repetition:** Repeat step5~step10 until prespecified  $G$ -th generation. If unsatisfied, go to step2.

As a result, we have a suboptimal control  $u(\mathbf{X})$  for the string with the best performance over all the past generations.

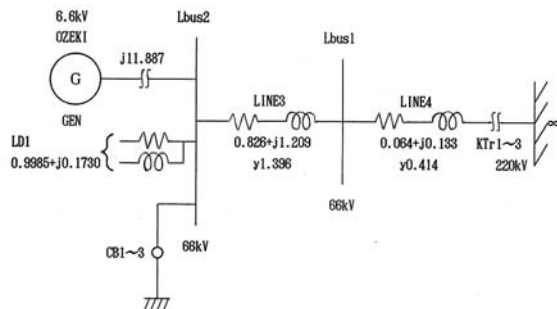

Fig. 3 Diagram of Ozeki-Power-Plant

IV. NUMERICAL EXAMPLE

Consider a field excitation control problem of power system. Fig. 3 is a diagram of Ozeki-Power-Plant of Kyushu Electric Power Company in Japan. This system is assumed to be described[7] by

$$\begin{aligned} \tilde{M} \frac{d^2\delta}{dt^2} + \tilde{D} \frac{d\delta}{dt} + P_e &= P_{in} \\ P_e &= E_I^2 Y_{11} \cos \theta_{11} + E_I \tilde{V} Y_{12} \cos(\theta_{12} - \delta) \\ E_I + T'_{d0} \frac{dE'_q}{dt} &= E_{fd} \\ E_I &= E'_q + (X_d - X'_d) I_d \\ I_d &= -E_I Y_{11} \sin \theta_{11} - \tilde{V} Y_{12} \sin(\theta_{12} - \delta) \\ \tilde{D} &= \tilde{V}^2 \left\{ \frac{T''_{d0}(X'_d - X''_d)}{(X'_d + X_e)^2} \sin^2 \delta \right. \\ &\quad \left. + \frac{T''_{q0}(X_q - X''_q)}{(X_q + X_e)^2} \cos^2 \delta \right\}, \end{aligned}$$

where  $\delta$ : phase angle,  $\dot{\delta}$ : rotor speed,  $\tilde{M}$ : inertia coefficient,  $\tilde{D}(\delta)$ : damping coefficient,  $P_{in}$ : mechanical input power,  $P_e(\delta)$ : generator output power,  $\tilde{V}$ : reference bus voltage,  $E_I$ : open circuit voltage,  $E_{fd}$ : field excitation voltage,  $X_d$ : direct axis synchronous reactance,  $X'_d$ : direct axis transient reactance,  $X_e$ : external impedance,  $Y_{11} \angle \theta_{11}$ : self-admittance of the network,  $Y_{12} \angle \theta_{12}$ : mutual admittance of the network, and  $I_d(\delta)$ : direct axis current of the machine. Put  $x = [x[1], x[2], x[3]]^T = [E_I - \hat{E}_I, \delta - \hat{\delta}_0, \delta]^T$  and  $u = E_{fd} - \hat{E}_{fd}$ , so that

$$\begin{bmatrix} \dot{x}[1] \\ \dot{x}[2] \\ \dot{x}[3] \end{bmatrix} = \begin{bmatrix} f_1(x) \\ f_2(x) \\ f_3(x) \end{bmatrix} + \begin{bmatrix} g_1(x) \\ 0 \\ 0 \end{bmatrix} u \quad (15)$$

where

$$\begin{aligned} f_1(x) &= -\frac{1}{kT'_{d0}}(x[1] + \hat{E}_I - \hat{E}_{fd}) \\ &\quad + \frac{(X_d - X'_d)\tilde{V}Y_{12}}{k} X_3 \cos(\theta_{12} - x[2] - \hat{\delta}_0) \\ f_2(x) &= x[3] \\ f_3(x) &= -\frac{\tilde{V}Y_{12}}{\tilde{M}}(x[1] + \hat{E}_I) \cos(\theta_{12} - x[2] - \hat{\delta}_0) \\ &\quad - \frac{Y_{11} \cos \theta_{11}}{\tilde{M}}(x[1] + \hat{E}_I)^2 - \frac{\tilde{D}}{\tilde{M}}x[3] + \frac{P_0}{\tilde{M}} \\ g_1(x) &= \frac{1}{kT'_{d0}}, \quad k = 1 + (X_d - X'_d)Y_{11} \sin \theta_{11}. \end{aligned}$$

Parameters are

$$\begin{aligned} \tilde{M} &= 0.016095[pu] & T'_{d0} &= 5.09907[sec] \\ \tilde{V} &= 1.0[pu] & P_0 &= 1.2[pu] \\ X_d &= 0.875[pu] & X'_d &= 0.422[pu] \\ Y_{11} &= 1.04276[pu] & Y_{12} &= 1.03084[pu] \\ \theta_{11} &= -1.56495[pu] & \theta_{12} &= 1.56189[pu] \\ X_e &= 1.15[pu] & X''_d &= 0.238[pu] \\ X_q &= 0.6[pu] & X''_q &= 0.3[pu] \\ T''_{d0} &= 0.0299[pu] & T''_{q0} &= 0.02616[pu] \\ \hat{E}_I &= 1.52243[pu] & \hat{\delta}_0 &= 48.57^\circ \\ \dot{\hat{\delta}}_0 &= 0.0[deg/sec] & \hat{E}_{fd} &= 1.52243[pu]. \end{aligned}$$

TABLE I  
 PERFORMANCES

Method	$x^T(0) : \text{initial point}$				
	[0, 0.4, 0]	[0, 0.5, 0]	[0, 1.0, -5]	[0, 1.2, 0]	[0, 1.3, 0]
LOC	0.95375	×	×	×	×
AACC(Hamil)	0.94224	1.23581	7.19167	1.90626	×
AACC(Lyap)	0.93033	1.23630	7.39742	1.85533	2.87179

× : very large value

Set  $\mathbf{X} = [x^T, x[4]]^T = [x[1], x[2], x[3], x[4]]^T$ ,  $n = 3$ ,  $\hat{X}_0 = \hat{\delta}_0 = 48.57^\circ$ ,  $C(x)=x[2]$ ,  $L = 1$ ,  $\mathbf{Q}=\text{diag}(1, 1, 1, 1)$ ,  $R=1$ ,  $\sigma_i = 0.33294(0 \leq i \leq M)$  and  $x[4](0)=1$ . Experiments are carried out for the new control(AACC), and the ordinary linear optimal control(LOC)[2].

1) AACC(Lyap):

$M=1$ ,  $\hat{X}_1 = 80^\circ$ ,  $D_0 = (-\infty, a - \hat{\delta}_0)$ ,  $D_1=[a - \hat{\delta}_0, \infty)$ . The parameters are suboptimally selected along the algorithm of section III.  $\Omega=\{\eta_i, N_{1i}, N_2, a\}$ ,  $G=100$ ,  $\tilde{q}=100$ ,  $\tilde{L}=8$ ,  $P_c=0.8$ ,  $P_m=0.03$ .

It results that  $\eta_i=1.840000$ ,  $N_{10}=3.864706$ ,  $N_{11}=0.896884$ ,  $N_2=9.752941$  and  $a=58.431373^\circ$ .

2) AACC(Hamil):

The parameters are suboptimally selected by minimizing the Hamiltonian[8].  $\Omega=\{N_{1i}, a\}$ . It results that  $N_{10}=2.517647$ ,  $N_{11}=1.035294$  and  $a=74.215686^\circ$ .

Table I shows performances by the AACC(Lyap), the AACC(Hamil) and the LOC. The cost function of Table I is

$$\tilde{J} = \frac{1}{2} \int_0^{25} (\mathbf{X}^T \mathbf{Q} \mathbf{X} + u^T \mathbf{R} u) dt.$$

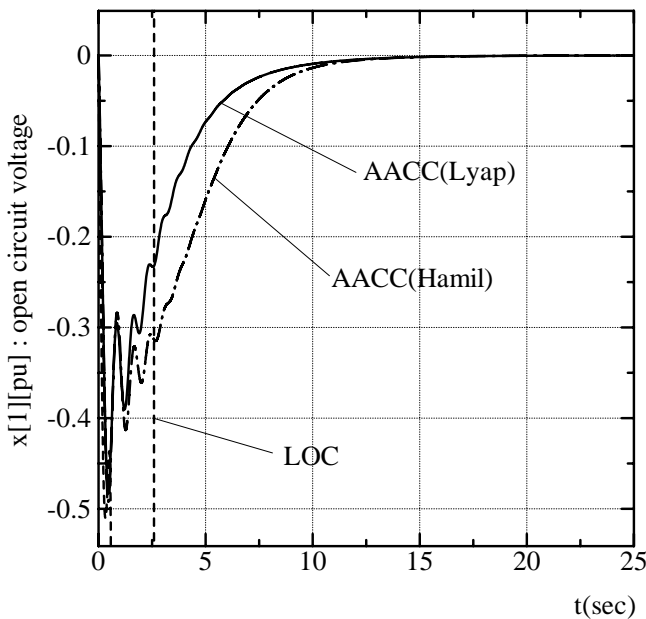

Fig. 4 Responses of LOC, AACC(Hamil), AACC(Lyap) ( $x^T(0) = [0, 1.2, 0]$ )

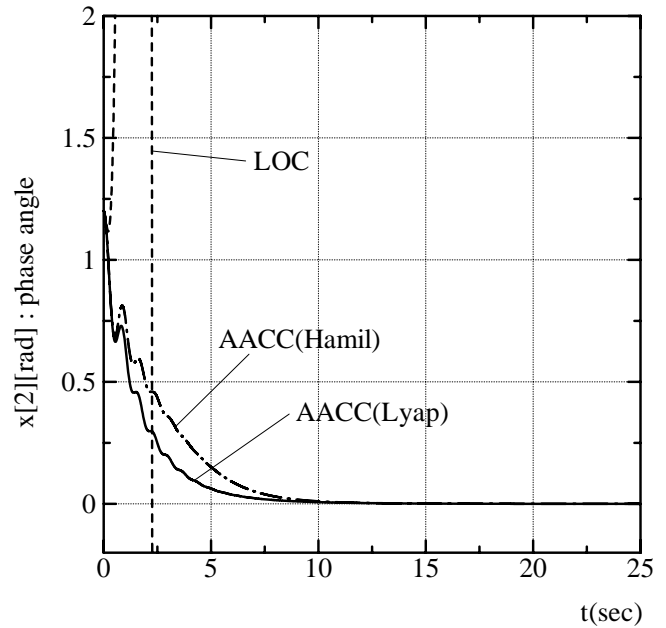

Fig. 5 Responses of LOC, AACC(Hamil), AACC(Lyap) ( $x^T(0) = [0, 1.2, 0]$ )

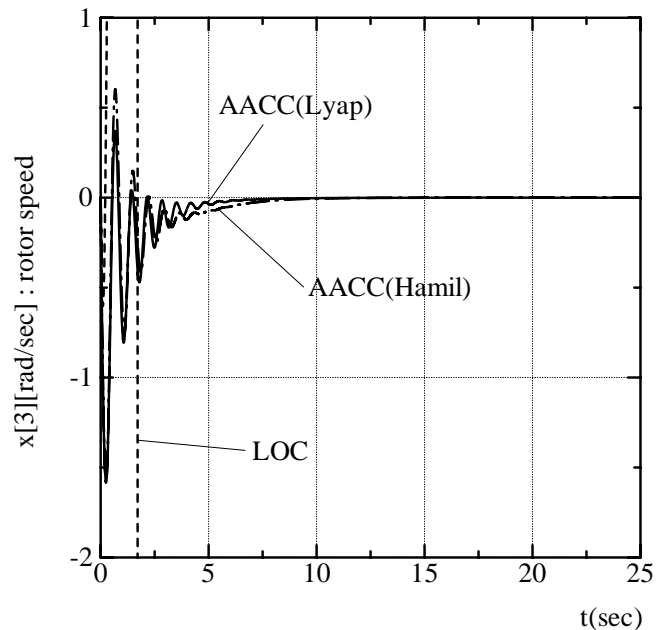

Fig. 6 Responses of LOC, AACC(Hamil), AACC(Lyap) ( $x^T(0) = [0, 1.2, 0]$ )

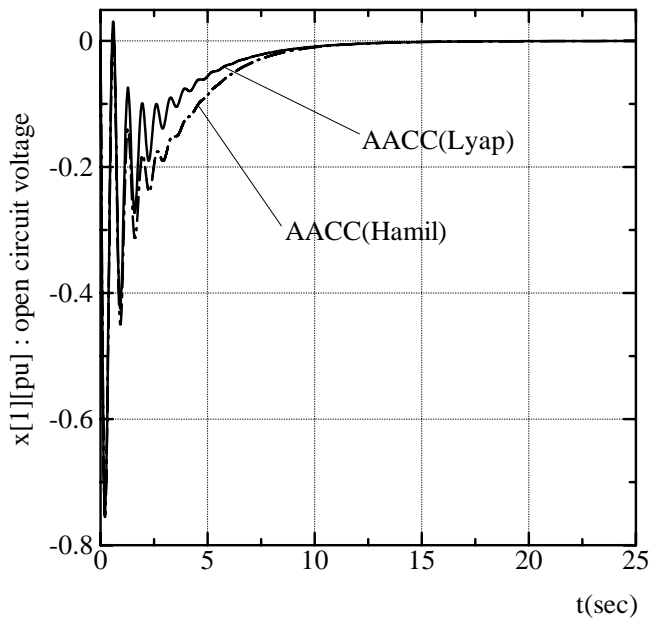

Fig. 7 Responses of AACC(Hamil), AACC(Lyap)  
 $(x^T(0) = [0, 1.0, -5])$

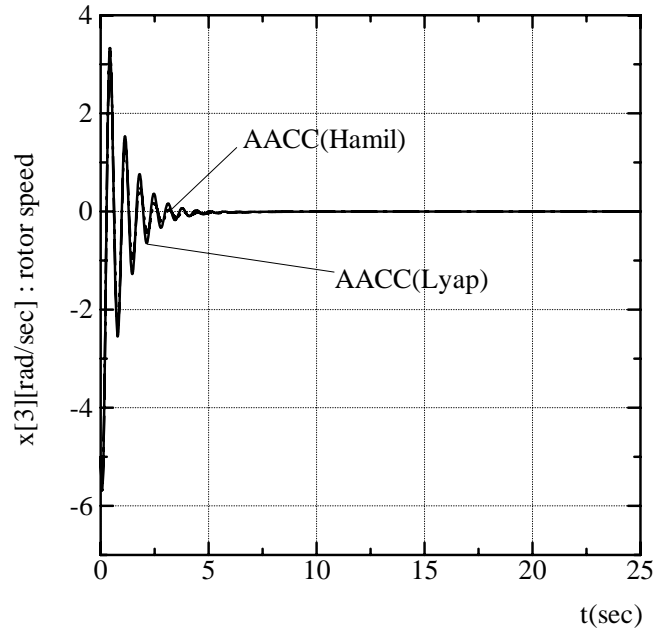

Fig. 9 Responses of AACC(Hamil), AACC(Lyap)  
 $(x^T(0) = [0, 1.0, -5])$

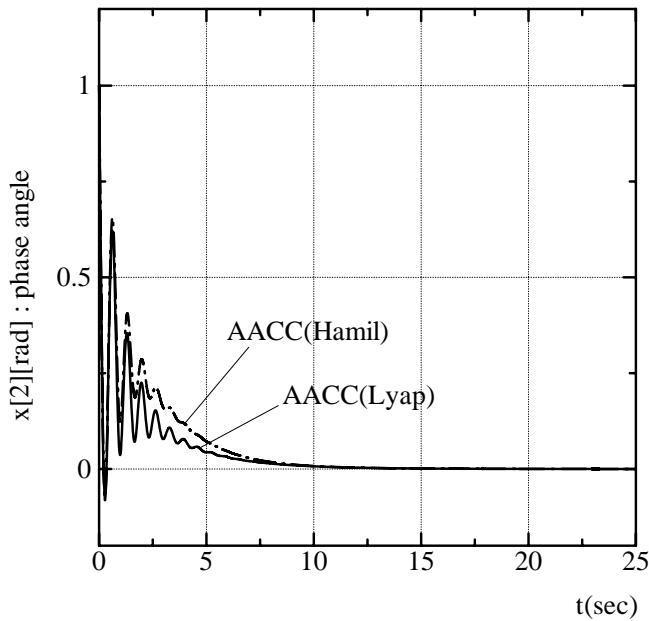

Fig. 8 Responses of AACC(Hamil), AACC(Lyap)  
 $(x^T(0) = [0, 1.0, -5])$

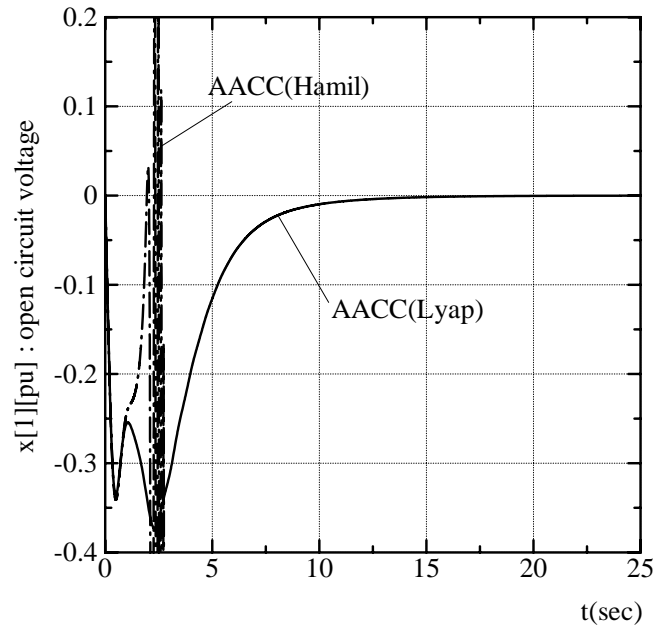

Fig.10 Responses of AACC(Hamil), AACC(Lyap)  
 $(x^T(0) = [0, 1.3, 0])$

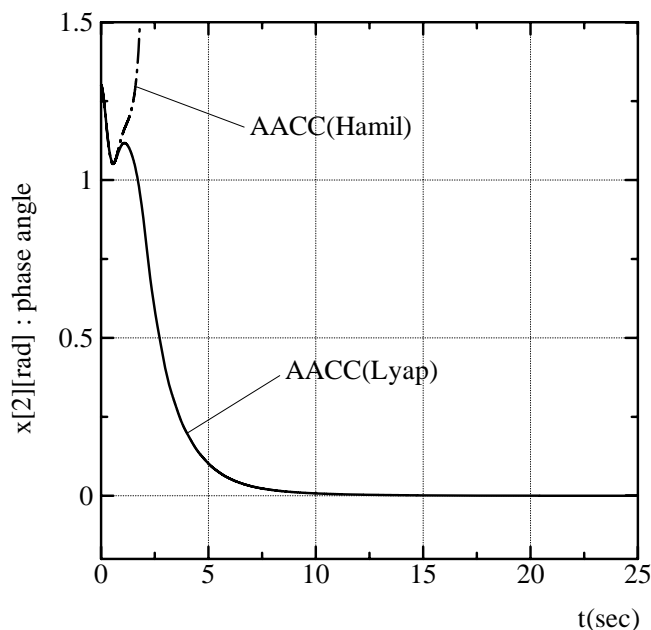

Fig.11 Responses of AACC(Hamil), AACC(Lyap)  
 $(x^T(0) = [0, 1.3, 0])$

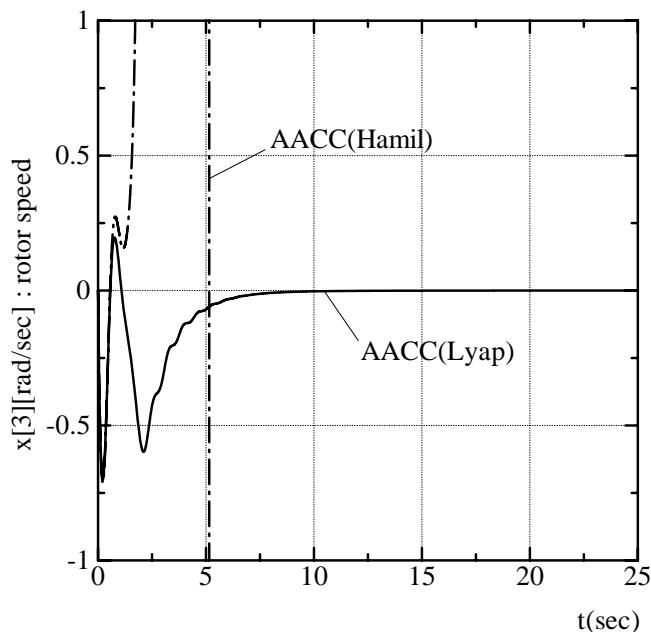

Fig.12 Responses of AACC(Hamil), AACC(Lyap)  
 $(x^T(0) = [0, 1.3, 0])$

Figs. 4, 5 and 6 show the responses in case of  $x^T(0) = [0, 1.2, 0]$ . Figs. 7, 8 and 9 show the responses in case of  $x^T(0) = [0, 1.0, -5]$ . Figs. 10, 11 and 12 show the responses in case of  $x^T(0) = [0, 1.3, 0]$ . These results indicate that the stable region of AACC(Lyap) is better than the AACC(Hamil) and LOC.

## V. CONCLUSIONS

We have studied an augmented automatic choosing control designed by Lyapunov functions using the gradient optimization automatic choosing functions for nonlinear systems. This approach was applied to a field excitation control problem of power system to demonstrate the splendiness of the AACC. Simulation results have shown that this controller could improve performance remarkably well.

## REFERENCES

- [1] Y. N. Yu, K. Vongsuriya and L. N. Wedman, "Application of an Optimal Control Theory to a Power System", *IEEE Trans. Power Apparatus and Systems*, 89-1, pp.55-62, 1970.
- [2] A. P. Sage and C. C. White III, "Optimum Systems Control (2nd edition)", *Prentice-Hall, Inc.*, 1977.
- [3] M. Vidyasagar, "Nonlinear Systems Analysis", *Prentice-Hall, Inc.*, 1978.
- [4] K.Glover and J.C.Doyle, "State-Space Formula for All Stabilizing Controllers that Satisfy and  $H_\infty$ -norm Bound and Relations to Risk Sensitivity", *System & Letters*, Vol.11-2, pp.167-172, 1988.
- [5] A.Isidori, "Nonlinear Control Systems : An Introduction (2nd edition)", *Springer-Verlag*, 1989.
- [6] H.Takata, "Automatic Choosing Control Design via GA for Nonlinear Systems", *Proc.38th IEEE CDC*, pp.5301-5306, 1999.
- [7] T.Nawata and H.Takata, "An Augmented Automatic Choosing Control Using Zero Dynamics for Nonlinear Systems and Its Application to a Power System", *Proc. 22nd IASTED MIC*, pp.191-196, 2003.
- [8] T.Nawata, "Computer Simulations of an Augmented Automatic Choosing Control Using Automatic Choosing Functions of Gradient Optimization Type", *Proc. WASET, Issue 71*, pp.578-583, 2010.
- [9] D. E. Goldberg, "Genetic Algorithms in Search, Optimization, and Machine Learnings", *Addison-Wesley Pub. Co. Inc.*, 1989.

**Toshinori Nawata** received his B.S.degree in Computer Science from Kyushu Institute of Technology in 1990 and his Dr. Eng. degree in System Information Engineering from Kagoshima University in 2003. He is currently an Associate Professor at the Department of Human-Oriented Information Systems Engineering, Kumamoto National College of Technology. His research interests include the nonlinear system control theory. Dr. Nawata is a member of IEEJ, IEICE and ISCIE.