

Speed -Sensorless Vector Control of Parallel Connected Induction Motor Drive Fed by a Single Inverter using Natural Observer

R. Gunabalan and V. Subbiah

Abstract—This paper describes the speed sensorless vector control method of the parallel connected induction motor drive fed by a single inverter. Speed and rotor fluxes of the induction motor are estimated by natural observer with load torque adaptation and adaptive rotor flux observer. The performance parameters speed and rotor fluxes are estimated from the measured terminal voltages and currents. Fourth order induction motor model is used and speed is considered as a parameter. The performance of the natural observer is similar to the conventional observer. The speed of an induction motor is estimated by MATLAB simulation under different speed and load conditions. Estimated values along with other measured states are used for closed loop control. The simulation results show that the natural observer is also effective for parallel connected induction motor drive.

Keywords—natural observer, adaptive observer, sensorless control

I. INTRODUCTION

SENSORLESS vector control of an induction motor drive essentially refers to vector control without any speed sensor. Speed sensor is not suitable for the environmental conditions, which suffers due to large shocks. Sensorless vector control is suitable from the point of reliability of the equipment, cost effectiveness and less maintenance. The speed is estimated from the measured terminal voltages and currents.

The field oriented control method of sensorless vector control has been generally applied to drive the induction motor accurately with one inverter driving one induction motor. However, in industrial applications such as electric traction and steel processing, one inverter may drive multiple induction motors connected in parallel on account of cost effectiveness, compactness and lightness, etc.

One important practical application is railway traction drives in which two to four induction motors must operate in parallel [1]. In most of the multiple induction motor drive systems 'single motor' vector control scheme is applied, which treats the parallel connected motors as one large induction motor. In

R. Gunabalan is with the Department of Electrical and Electronics Engineering (PG), Sri Ramakrishna Engineering College, Anna University, Coimbatore, TamilNadu, INDIA (e-mail: gunabalanr@yahoo.co.in).

V. Subbiah is with the Department of Electrical and Electronics Engineering, Sri Krishna College of Engineering and Technology, Anna University, Coimbatore, TamilNadu, INDIA (e-mail: subbiah42@yahoo.com).

some drive systems, speed sensor is attached to only one motor properly chosen from among many motors. However, in these methods unbalances of torque and current make the system unstable.

Various types of multiple-motor drive systems have been proposed to solve this problem [4]-[5]. Most multiple-motor drive systems employ either 'single motor' vector control, which treats motors connected as one large motor, or a drive system controlled by a single speed sensor attached to the most suitable of the motors. If for some reason an imbalance arises among the torques and currents, the drive system becomes unstable and it is eliminated by the average value of the parameters of the motors. To achieve sensorless control, adaptive rotor flux observer is used to estimate stator currents, rotor fluxes and speed [2]-[3]. In this paper the natural observer is used to estimate speed and rotor flux. Its dynamic behavior is therefore the same as the natural behavior of the actual system. The most important difference between natural observers and conventional observers is that natural observers do not use feedback directly, the feedback being used only in the adaptation algorithm.

Simulations are carried out for step change in speed, step change in torque and both step change in speed and torque. The results for the change in torque are compared with those obtained by the conventional method.

The paper is organized as follows: Section II reviews the natural observer concept and its advantages. Parallel connected induction motor drive system is discussed in section III and results are discussed in section IV under different running conditions.

II. NATURAL OBSERVER

An observer which is exactly the same form as the actual induction motor model without any feedback is called natural observer. It has the natural characteristics of the actual motor under the same conditions of load torque and input voltage. Its convergence will be as fast as that of the motor in reaching its steady state, which is fast enough for most applications.

To estimate the rotor speed of an induction machine using natural observer, the motor model proposed in [6] is fifth order model. In this work, fourth order model is used similar to Kubota's adaptive observer [2] – [3]. The state space representation of the system is as follows:

$$\frac{dX}{dt} = AX + BU \quad (1)$$

$$Y = CX \quad (2)$$

$$A = \begin{bmatrix} -1/T_s & 0 & L_m/L'_s L_r \tau_r & \omega_r L_m/L'_s L_r \\ 0 & -1/T_s & -\omega_r L_m/L'_s L_r & L_m/L'_s L_r \tau_r \\ L_m/\tau_r & 0 & -1/\tau_r & -\omega_r \\ 0 & L_m/\tau_r & \omega_r & -1/\tau_r \end{bmatrix}$$

$$B = \begin{bmatrix} 1/\sigma L_s & 0 \\ 0 & 1/\sigma L_s \\ 0 & 0 \\ 0 & 0 \end{bmatrix} \quad C = \begin{bmatrix} 1 & 0 & 0 & 0 \\ 0 & 1 & 0 & 0 \end{bmatrix}$$

where,

$$\frac{1}{T_s} = \frac{R_s + R_r (L_m / L_r)^2}{L'_s}$$

$$L'_s = \sigma L_s$$

$$X = \begin{bmatrix} i_{ds}^s & i_{qs}^s & \phi_{dr}^s & \phi_{qr}^s \end{bmatrix}^T$$

$$Y = \begin{bmatrix} i_{ds}^s & i_{qs}^s \end{bmatrix}^T = i_s$$

$$U = \begin{bmatrix} v_{ds}^s & v_{qs}^s \end{bmatrix}^T$$

R_s, R_r -stator and rotor resistance respectively (ohm)

L_s, L_r -stator and rotor self inductance respectively (H)

L_m -mutual inductance (H)

$$\sigma = 1 - \frac{L_m^2}{L_s L_r} \text{ -leakage coefficient}$$

$$\tau_r \text{ -rotor time constant} = \frac{L_r}{R_r}$$

ω_r -motor angular velocity (rad/s)

The natural observer, shown in Fig. 1 for the system described by (1) and (2) is in exactly the same form as the actual system model and has no external feedback.

The natural observer which estimates the stator current and the rotor flux is written by the following equations:

$$\frac{d\hat{X}}{dt} = \hat{A} \hat{X} + BU \quad (3)$$

$$Y = CX \quad (4)$$

The estimated quantities are denoted by “ $\hat{}$ ”.

Load torque is estimated using the active power error as the correction term and \hat{T}_L is kept within two particular limits to avoid unstable oscillations [6].

$$\hat{T}_L = K_D e_p + K_P e_p + K_I \int e_p dt \text{ limiting} \quad (5)$$

$$\hat{T}_L \in (T_{\min}, T_{\max})$$

where $e_p = \hat{P} - P = v_{ds} (\hat{i}_{ds} - i_{ds}) + v_{qs} (\hat{i}_{qs} - i_{qs})$

$$\dot{e}_p = v_{ds} \dot{\hat{i}}_{ds} + v_{qs} \dot{\hat{i}}_{qs} + \dots \dots \dots$$

$$\dot{e}_p = \frac{M}{\sigma L_s L_r} (v_{ds} \hat{\phi}_{qr} - v_{qs} \hat{\phi}_{dr}) \hat{\omega}_r + \dots \dots \dots$$

where “...” denotes all of the other terms not including $\hat{\omega}_r$. These terms are disregarded because \hat{T}_L appears only in the derivative of $\hat{\omega}_r$.

$$\dot{\hat{\omega}}_r = (3/2)(n_p/J)(M/L_r)[\hat{\phi}_{dr} \hat{i}_{qs} - \hat{\phi}_{qr} \hat{i}_{dr}] - \hat{T}_L/J \quad (6)$$

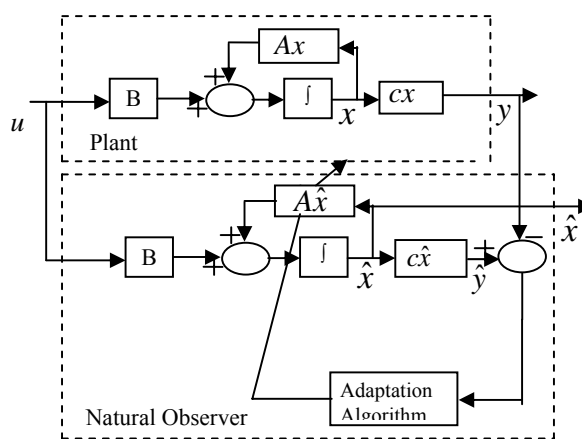

Fig. 1 Natural observer with adaptation

The block diagram representation of system is shown in Fig.2. The rotor speed is estimated from the estimated stator current, rotor flux and the estimated load torque. The speed estimation technique in [2] - [5] always needs some correction term in order to follow speed changes. This results in the estimations always lagging the actual values. In natural observer, the speed estimation follows the speed changes simultaneously.

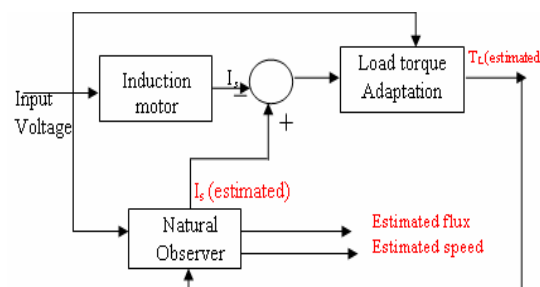

Fig. 2 Block diagram representation

III. VECTOR CONTROL OF PARALLEL CONNECTED INDUCTION MOTOR DRIVE

A. Current Model

Concerning two parallel connected induction motors fed by a single inverter, the current flowing in each motor are unbalanced if there is a difference between the motor speeds or the machine parameters. Fig. 3 shows the current flowing in the parallel connected induction motor. The currents i_{s1} and i_{s2} flowing in each stator winding can be represented by \bar{i}_s which flows equally in both stator windings. Since \bar{i}_s is half of the input current i_x , it can be represented as input current.

$$\bar{i}_s = \frac{i_{s1} + i_{s2}}{2} \quad (7)$$

This \bar{i}_s current is compared with the reference current i_s^* to produce the required control voltage for the inverter.

B. Reference Current of Parallel Connected Induction Motor Drive

The equations for the reference current of an induction motor in a rotating reference frame by direct vector control method are framed by the following equations:

$$\bar{i}_{ds}^{*e} = \frac{1}{U} \left(\bar{S}_r \bar{\phi}_{dr}^{*e} + \Delta \bar{S}_r \Delta \hat{\phi}_{dr}^{*e} - \Delta U \Delta \hat{i}_{ds}^{*e} + \Delta \hat{\omega}_r \Delta \hat{\phi}_{qr}^{*e} \right)$$

$$\hat{i}_{qs}^{*e} = \frac{\frac{\bar{T}^*}{pM} + \Delta \bar{i}_{ds}^{*e} \Delta \hat{\phi}_{qr}^{*e} - \Delta \bar{i}_{qs}^{*e} \Delta \hat{\phi}_{dr}^{*e}}{\Delta \hat{\phi}_{dr}^{*e}}$$

$$\bar{T}^* = \frac{\bar{T}_e - \left(\frac{\Delta \bar{M}'}{\bar{M}} \right) \Delta \bar{T}_e}{1 - \left(\frac{\Delta \bar{M}'}{\bar{M}} \right)^2}$$

$$\bar{M} = \frac{L_{m1} + L_{m2}}{2}$$

$$\bar{M}' = \frac{1}{2} \left(\frac{L_{m1}}{L_{r1}} + \frac{L_{m2}}{L_{r2}} \right)$$

$$\Delta \bar{M}' = \frac{1}{2} \left(\frac{L_{m2}}{L_{r2}} - \frac{L_{m1}}{L_{r1}} \right)$$

$$U = S_r M$$

$$\bar{U} = \frac{U_1 + U_2}{2}$$

$$\bar{i}_s^e = \frac{i_{s1}^e + i_{s2}^e}{2}$$

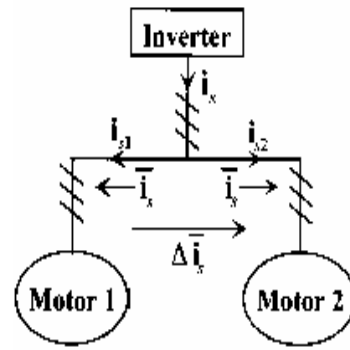

Fig. 3 Current flows for parallel connected induction motor

$$\hat{\omega}_r = \frac{\omega_{r1} + \omega_{r2}}{2}$$

$$\Delta \hat{\omega}_r = \frac{\hat{\omega}_{r2} - \hat{\omega}_{r1}}{2}$$

$$\bar{S}_r = \frac{S_{r1} + S_{r2}}{2}$$

$$\Delta S_r = \frac{S_{r2} - S_{r1}}{2}$$

$$S_r = \frac{1}{\tau_r}$$

$$\tau_r = \frac{L_r}{R_r}$$

$$\Delta \bar{U} = \frac{U_2 - U_1}{2}$$

$$\Delta i_s^e = \frac{i_{s2}^e - i_{s1}^e}{2}$$

C. Reference Torque of Parallel Connected Induction Motor Drive

The average torque of dual induction motors is represented by the following equation:

$$\bar{T}_e^* = \frac{T_{e1}^* + T_{e2}^*}{2} \quad (8)$$

T_{e1}^* and T_{e2}^* are derived from the controller.

T_{e1}^*, T_{e2}^* - reference Torque for motor 1 and motor 2.

In [2-5], speeds of the induction motors connected in parallel are estimated by Kubota's method (Luenberger observer). In this paper, speeds are estimated by natural observer with load torque adaptation.

Fig. 4 shows the configuration of the parallel connected induction motor drive system. The main components are two adaptive load torque estimation with natural observer for each induction motor (or Luenberger observer), calculation block of two reference current values and current regulated pulse width modulated voltage source inverter. Estimated speeds are calculated from the measured terminal voltages and currents in the adaptive rotor flux observers. The torque reference of each induction motor is calculated from the difference between speed reference and estimated speed by using PI controllers. The reference of the average torque is calculated from (8).

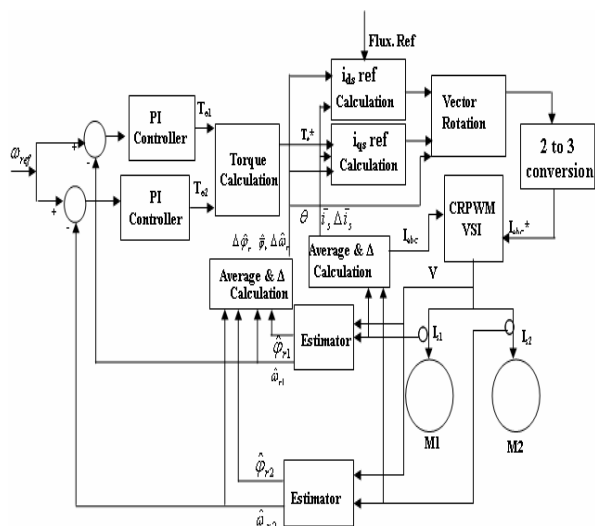

Fig 4 Configuration of parallel connected induction motor

IV. SIMULATION RESULTS

Table I shows the rating of the induction motor used for simulation. Direct oriented field sensorless control scheme is used. The torque adaptation gains are $K_p = 0.005$, $K_i = 0.2$ and $K_D = 0$. Load torque is limited between 85 Nm to -85 Nm for estimators.

A. Step Change in Speed and Load

Fig. 5 illustrates the simulation results for a step change in speed and load. The reference speed command is set at 1000 rpm. At $t = 1.5$ s, speed command is changed from 1000 rpm to 1200 rpm. The estimated and actual speed responses of both the motors are shown in Fig. 5(a) and 5(b). The estimated speed follows the speed command; and, as can be seen in Fig. 5(a) and 5(b), the estimated speed matches the actual speed of the motors. Initially neither motor has load; and at $t = 3$ s, a balanced load of 5 Nm is applied to both the motors. At balanced load condition, the estimated speeds match the speed command. This is because, $\Delta\omega_r$, Δi_s etc., are all zero when the conditions are the same, thus allowing the two motors to be treated as a single motor. The torque of both motors is estimated by load torque adaptation and the torque response is shown in Fig. 5(c). The estimated torque follows the actual load torque.

TABLE I
 RATING AND PARAMETERS OF INDUCTION MOTOR

Motor Rating	
Output	3.7 kW
Poles	4
Voltage	160 V
Current	20 A
Motor Speed	1500 rpm
R_s	0.3831 ohm
R_r	0.2367 ohm
L_s	33.34 mH
L_r	33.34 mH
L_m	32.11 mH

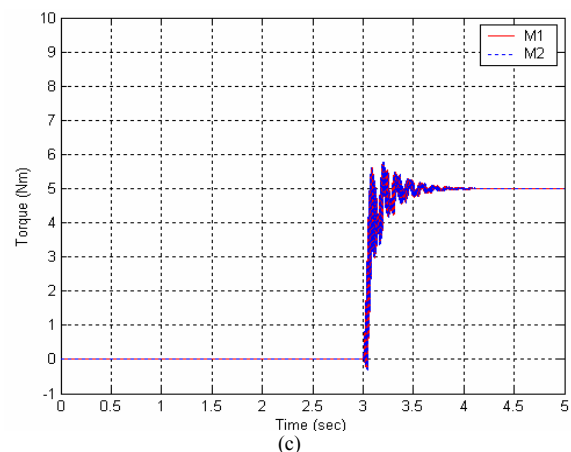
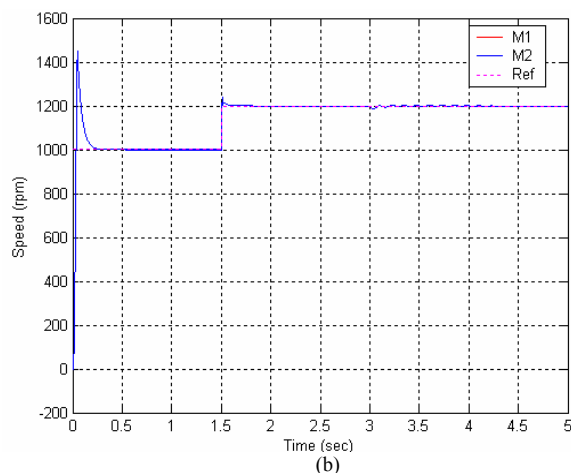
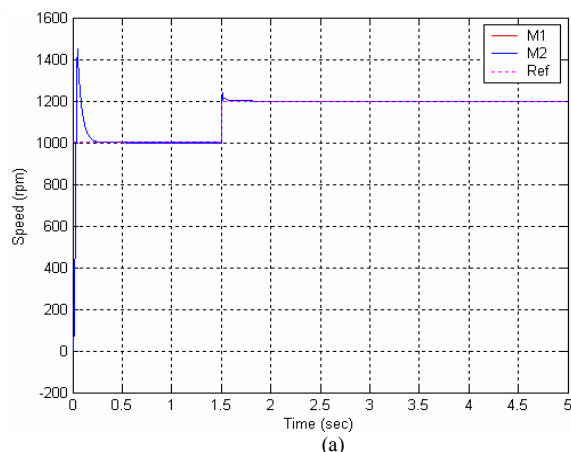

Fig. 5 Step change in speed and load test.

(a) Estimated speed response (b) Actual speed response
 (c) Estimated torque response

B. Unbalanced Load

Fig.6 shows some simulation results for unbalanced load condition. The reference speed of both the motors set at 1200 rpm. At $t = 1.5$ s, the load in motor 1 is increased from 0 Nm to 5 Nm. Motor 2 runs at no load condition. The estimated and actual speed responses of both the motors are shown in Fig.

6(a) and 6(b). After $t = 1.5$ s, as can be seen in Fig. 6(a) and 6(b), the estimated speed deviates from the reference speed of the motors. The speed of motor 1 decreases slightly by around 8 rpm with respect to the reference speed and the speed of motor 2 increases by the same rate because the speeds of both motors are fed back and compared with the speed command, thus enabling the difference between them to be reduced. As a result, the speed of each motor converges uniformly. At $t = 3$ s, motor 2 is loaded with 5 Nm and the estimated speed follows the speed command. Therefore, the estimated speeds for natural observer are stable, thus enabling the motors to run in parallel. It is observed that the estimated speed deviated from the command speed only when the conditions of the two motor are different. In addition to speed estimation, the torque of the both machines is estimated in natural observer and the ripple present in the torque is less under steady state condition and there is no external filter is required. The performance of the natural observer is compared with Kubota's method and the comparison is given in Table II. Fig. 7 shows the response of the Kubota's method.

The error under transient condition in natural observer is less than Kubota's method (fewer oscillations and fewer settling time) at sudden loading. The natural observer is not therefore affected by these transitory operating conditions. Torque is not estimated in Kubota's method. The estimated speed response and actual torque response are shown in Fig. 7(a) and 7(b). The performance of the natural observer is better than Kubota's method and Luenberger observer is replaced by a natural observer for the same steady state response with improved transient response.

TABLE II
 PERFORMANCE COMPARISON

Performance Parameters	Kubota's Method	Natural Observer
Peak overshoot	High	Low
Oscillation	High	Low
Settling time	0.7s	0.4s
Torque	Not estimated	Estimated

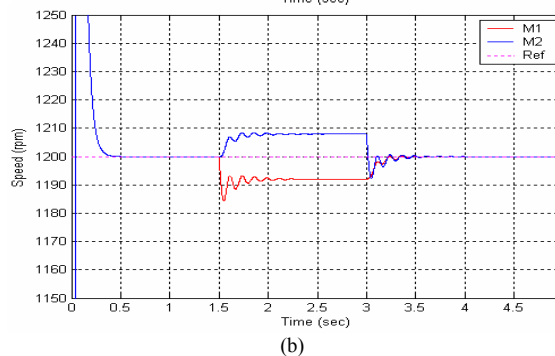
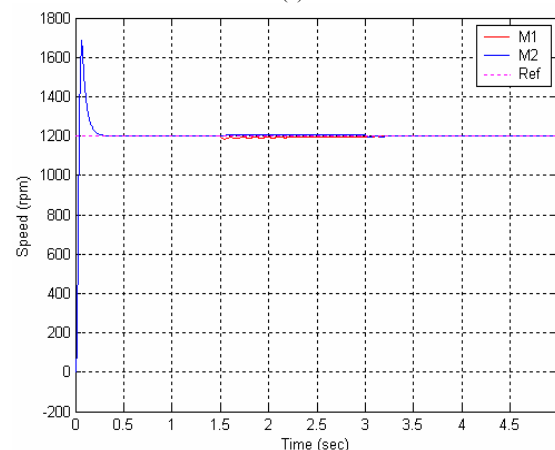
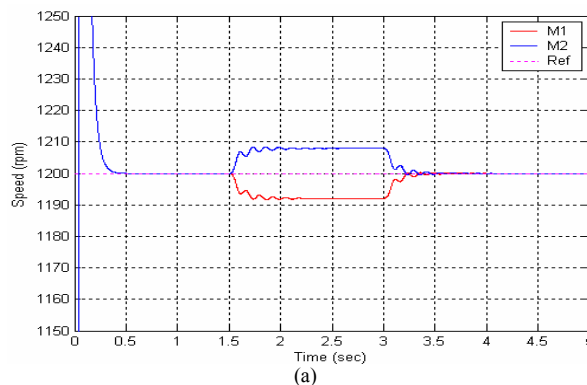
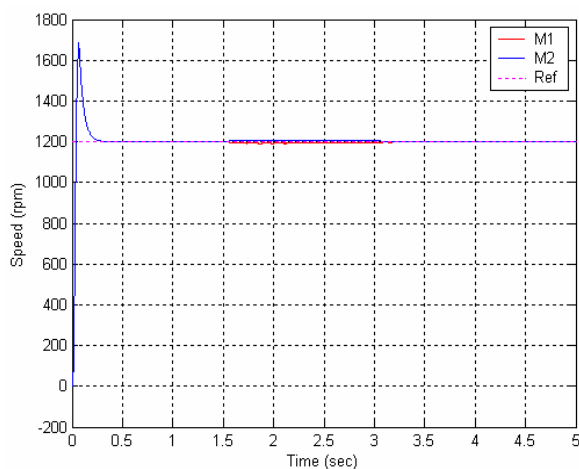

Fig. 6 Unbalanced load test
 (a) Estimated speed response (b) Actual speed response
 (c) Estimated torque response

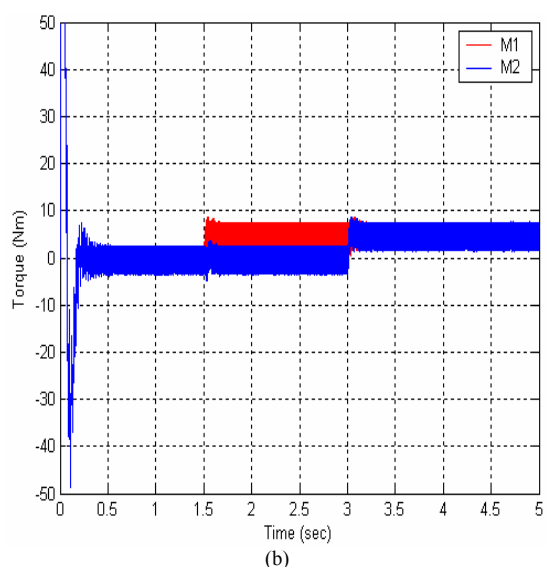
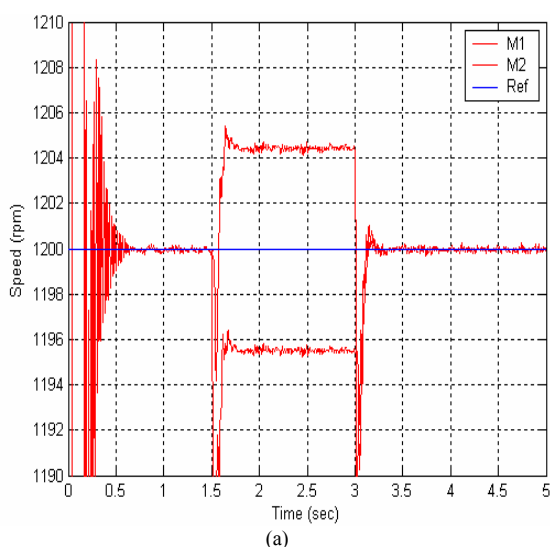
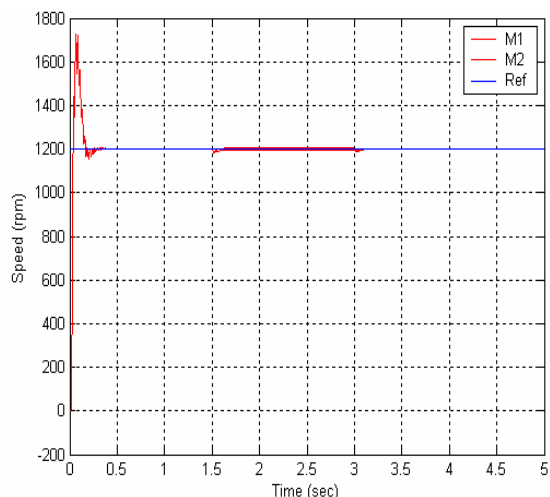

Fig. 7 Unbalanced load test Kubota's method

(a) Estimated speed response (b) Actual torque response

V. CONCLUSION

The natural observer design technique and adaptation algorithms have been shown to be very simple and successful. Natural observer has a number of advantages over conventional observer. In particular, since in the natural observer convergence is achieved using parameter adaptation, the convergence problems of the adaptation algorithm and observer are simplified. The validity and effectiveness of the proposed method are confirmed through simulation.

ACKNOWLEDGMENT

The authors are grateful to the Principal and Management of Sri Ramakrishna Engineering College and Sri Krishna College of Engineering and Technology, Coimbatore for the encouragement and for the computer facilities made available for carrying out the work reported here.

REFERENCES

- [1] B.K.Bose, "Modern Power Electronics and AC Drives", Upper Saddle River, NJ: Prentice-Hall, 2001, pp.348-350.
- [2] H. Kubota and K. Matsuse, "Speed sensorless field-oriented control of induction motor with rotor resistance adaptation," *IEEE Trans. Industrial Applications*, vol. 30, pp. 1219-1224, Sept./Oct. 1994.
- [3] H. Kubota, K. Matsuse, and T. Nakano, "DSP-Based Speed Adaptive Flux Observer of Induction Motor," *IEEE Trans. Industrial Applications*, vol. 29, pp. 344-348, Mar./Apr. 1993.
- [4] K. Matsuse, Y. Kouno, H. Kawai and J. Oikawa, "Characteristics of speed sensor-less vector controlled dual induction motor drive connected in parallel fed by a single Inverter", *IEEE Trans. Industrial Applications.*, vol. 40, pp. 153-161, Jan./Feb. 2004.
- [5] K. Matsuse, Y. Kouno, H. Kawai and S. Yokomizo, "A Speed-sensorless vector control method of parallel-connected dual induction motor fed by a single inverter," *IEEE Trans. Industrial Applications*, vol. 38, pp. 1566-1571, Nov./Dec. 2002.
- [6] Sidney R. Bowes, Ata Sevinc and Derrick Holliday, "New natural observer applied to speed sensorless DC servo and induction motors," *IEEE Trans. Industrial Applications.*, vol. 51, no.5, pp. 1025-1032, Oct. 2004.



R. Gunabalan (M'2008) obtained his B.E. in Electrical and Electronics Engineering in Government College of Engineering Tirunelveli, Manonmaniam Sundaranar University, Tamilnadu, India, in 2000 and did his Master of Technology (Electrical Drives & Control) in Pondicherry Engineering College, Pondicherry University, India, in 2006.

He worked as a Lecturer and Senior Lecturer in various institutions. He is having 8 years of teaching experience. He is currently pursuing his PhD from Anna University, Coimbatore, Tamilnadu, India. He is working as a senior Lecturer in the department of Electrical and Electronics Engineering, Sri Ramakrishna Engineering College, Coimbatore, Tamilnadu, India. He published 7 papers in national conferences, 2 papers in international conferences and one paper in international journal. He is working in the area of sensorless vector control and DSP control.

Mr. R. Gunabalan is a life member in ISTE.