

Application of Artificial Intelligence for Tuning the Parameters of an AGC

R. N. Patel

Abstract—This paper deals with the tuning of parameters for Automatic Generation Control (AGC). A two area interconnected hydrothermal system with PI controller is considered. Genetic Algorithm (GA) and Particle Swarm optimization (PSO) algorithms have been applied to optimize the controller parameters. Two objective functions namely Integral Square Error (ISE) and Integral of Time-multiplied Absolute value of the Error (ITAE) are considered for optimization. The effectiveness of an objective function is considered based on the variation in tie line power and change in frequency in both the areas. MATLAB/SIMULINK was used as a simulation tool. Simulation results reveal that ITAE is a better objective function than ISE. Performances of optimization algorithms are also compared and it was found that genetic algorithm gives better results than particle swarm optimization algorithm for the problems of AGC.

Keywords— Area control error, Artificial intelligence, Automatic generation control, Genetic Algorithms and modeling, ISE, ITAE, Particle swarm optimization.

I. INTRODUCTION

A large volume of work has already been reported in the field of automatic generation control [1]-[11]. In most of the previous works on interconnected systems, tie-line bias control strategy has been widely accepted by utilities. In this method, Area Control Error (ACE) is calculated through feedback for each area and control action is taken to regulate ACE to zero. Thus, the frequency and the interchanged power are kept at their desired values. A bias constant is used for each area to give relative importance to the frequency error with respect to the tie-line power error. ACE for i^{th} ($i = 1, 2$) area is defined by utilities as [6]:

$$ACE_i = \Delta P_{\text{tie},i} + B_i \Delta F_i \quad (1)$$

where,

ACE_i = Area Control Error of i^{th} area in p.u. MW

$\Delta P_{\text{tie},i}$ = Deviation in tie-line power in p.u. MW

B_i = Frequency Bias in p.u. MW/Hz

ΔF_i = Deviation in frequency in Hz

Performance of any controller depends upon the values of its different parameters. In order to get the best-suited values

of these parameters optimization is required. There are several algorithms to optimize different types of functions. In the problems related to AGC, conventional optimization algorithms don't work effectively. During the last couple of decades a great amount of effort has been made for the improvement of AGC algorithms and development of robust controllers that use Artificial Intelligence (AI) techniques. Amongst these techniques, genetic algorithm has proven to be well established and particle swarm optimization can be considered as another emerging technique. These techniques can be used effectively for variety of problems in engineering and technology including AGC.

In the present work, following three parameters have been identified for optimization purpose:

K_p , which is a proportional constant multiplied with ACE for control action,

K_i , is integral constant multiplied with integral of ACE for control action,

and B_i as defined above in (1).

In this paper the effect of two different objective functions is studied for optimization of parameters. First is ISE [2], [4] and second is ITAE [9]. These are defined as follows:

$$ISE = \int_0^{\infty} e^2(t) dt \quad (2)$$

$$ITAE = \int_0^{\infty} t |e(t)| dt \quad (3)$$

where, e corresponds to error.

In ISE, only error is considered and therefore no weight is given to time span of error. But, for the problem of AGC, it is required that settling time should be less and also oscillations should die out sooner. To this end in ITAE is taken as integration of time multiplied error, so that oscillations die out sooner.

This paper gives comparative evaluation of GA and PSO with the above two objective functions. Previous works in this area [10]-[12] primarily deal with a typical thermal-thermal system with the use of only one of the AI techniques. Hence, the aim in this paper is to evaluate the comparative performance of both the important AI techniques, namely GA and PSO. The un-optimized AGC performance is also compared with that of AI optimized AGC, in order to appreciate the benefit of parameter tuning.

Manuscript received May 25, 2007. This work was supported by the Department of Science and Technology, Govt. of India through the FAST TRACK Project for young scientists vide the Grant no. SR/FTP/ETA-03/2005.

R. N. Patel is with the Department of Electrical and Electronics Engineering, Shri Shankaracharya College of Engineering and Technology, Junwani, PO- Nehru Nagar, Bhilai (C.G.) 490 020, India. (phone: 91-788-2291605; fax: 91-788-2291606; e-mail: ramnpatel@gmail.com).

II. APPLICATION OF GENETIC ALGORITHM

The genetic algorithm [1], [3], [5] is a global search technique for solving optimization problems, which is essentially based on the theory of natural selection, the process that drives biological evolution. Following are the important terminology in connection with the genetic algorithm:

Individual - An individual is any point to which objective function can be applied. It is basically the set of values of all the variables for which function is going to be optimized. The value of the objective function for an individual is called its *score*. An individual is sometimes referred to as a *genome* and the vector entries of it as *genes*.

Population - It is an array of individuals. For example, if the size of the population is 100 and the number of variables in the objective function is 3, population can be represented by a 100-by-3 matrix in which each row correspond to an individual.

Generation - at each iteration, the genetic algorithm performs a series of computations on the current population to produce a new population by applying genetic operators. Each successive population is called a new generation.

Parents and children - To create the next generation, the genetic algorithm selects certain individuals in the current population, called parents, and uses them to create individuals in the next generation, called children.

Following three genetic operators [5] are applied on parents to form children for next generation:

1. **Reproduction** - Selects the fittest individuals in the current population to be used in generating the next population. The children are called *Elite children*.
2. **Cross-over** - Causes pairs of individuals to exchange genetic information with one another. The children are called *Crossover children*.
3. **Mutation** - Causes individual genetic representations to be changed according to some probabilistic rule. The children in this case are called *Mutation children*.

Fig. 1 shows the flow chart for genetic algorithm.

III. APPLICATION OF PARTICLE SWARM OPTIMIZATION ALGORITHM

Particle swarm optimization (PSO) [7], [8] is a population based stochastic optimization technique inspired by social behavior of bird flocking or fish schooling. The system is initialized with a population of random solutions and searches for optima by updating generations. In PSO, the potential solutions, called particles, fly through the problem space by following the current optimum particles. In PSO system, each individual adjusts its flying according to its own flying experience and its companion's flying experience. Each particle keeps track of its coordinates in the problem space which are associated with the best solution (fitness) it has achieved so far. This value is called 'pbest'. Another "best" value that is tracked by the particle swarm optimizer is the best value, obtained so far by any particle in the population. This best value is a global best and called 'gbest'.

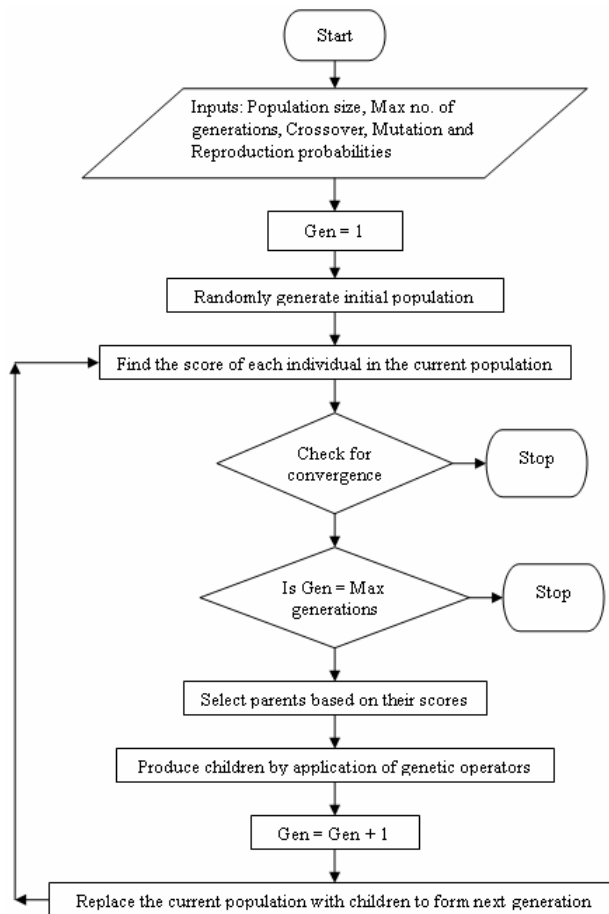

Fig. 1 flow chart of genetic algorithm

In each iteration, every particle is updated using these two "best" values. After finding the two best values, the particle updates its velocity and positions with following equations (4) and (5).

$$v[] = v[] + c1 * rand() * (pbest[] - present[]) + c2 * rand() * (gbest[] - present[]) \quad (4)$$

$$present[] = present[] + v[] \quad (5)$$

where, $v[]$ = particle velocity,

$present[]$ = current particle (solution),

$rand()$ = random number between (0,1),

$c1, c2$ are learning factors, usually $c1 = c2 = 2$

and $pbest[]$ and $gbest[]$ are defined as discussed earlier.

Fig. 2 shows the flow chart of particle swarm optimization algorithm.

IV. COMPARISONS BETWEEN OPTIMIZATION ALGORITHMS

The genetic algorithms and particle swarm optimization algorithm search from many points in the search space at once and yet continually narrow the focus of the search to the areas of the observed best performance. These algorithms can be applied to solve a variety of optimization problems that are not well-suited for standard optimization algorithms, including problems in which the objective function is discontinuous, non-differentiable, stochastic, or highly nonlinear.

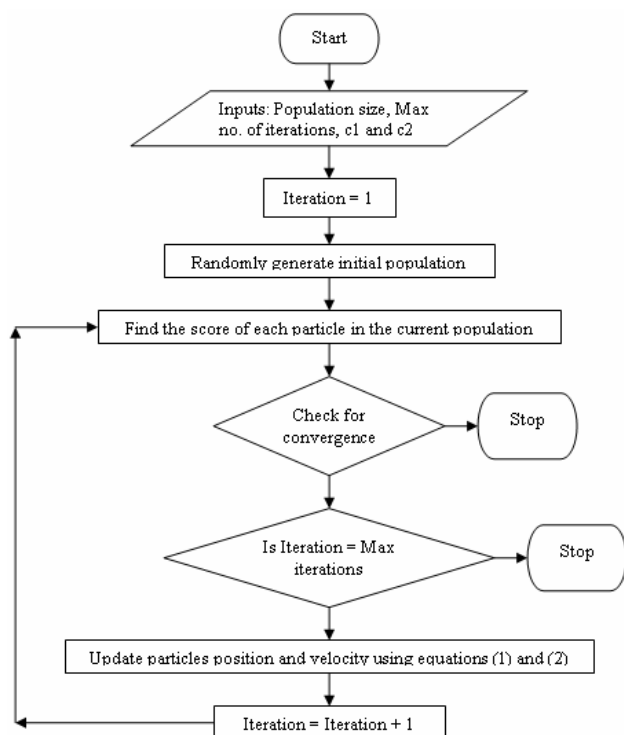

Fig. 2 flow chart of particle swarm optimization

GA and PSO converge to global optima unlike the conventional optimization techniques, since they search from a population of points and are based on probabilistic transition rules. Conventional optimization techniques are ordinarily based on deterministic hill-climbing methods, which, by definition, will only find local optima.

Most of the evolutionary techniques have the following procedure:

1. Random generation of an initial population
2. Reckoning of a fitness value for each subject. It will directly depend on the distance to the optimum.
3. Reproduction of the population based on fitness values.
4. If requirements are met, then stop. Otherwise go back to 2.

From the above procedure, it was observed that PSO shares many common points with GA. Both algorithms start with a group of a randomly generated population, both have fitness values to evaluate the population. Both update the population and search for the optimum with random techniques. However, PSO does not have genetic operators like crossover and mutation. Particles update themselves with the internal velocity. They also have memory, which is important to the algorithm.

Compared with GA, the information sharing mechanism in PSO is significantly different. In GA, chromosomes share information with each other. Therefore, the whole population moves like a one group towards an optimal area. On the other hand in PSO, only 'gbest' gives out the information to others and therefore it is a one-way information sharing mechanism.

V. ILLUSTRATIVE SYSTEM EXAMPLE

In the literature a lot of works concerning AGC have already been reported considering conventional controllers. Although, many studies pertaining to thermal plants are available, only few works deal with the area of hydrothermal systems provided with reheater and electric governor.

In the present work, investigations have been carried out on an interconnected hydrothermal system provided with reheat type of turbine and electric governor as shown in Fig. 3. The system parameters are given in Appendix. MATLAB (/Simulink) [13] is used as a simulation tool to obtain dynamic responses for ΔF_1 , ΔF_2 and P_{tie} for 1% step load perturbation in thermal area.

The turbine governor parameters are given in Appendix. For the purpose of optimization, the controller parameters for both areas are assumed to be same, i.e. $K_{i1} = K_{i2} = K_i$, $K_{pr1} = K_{pr2} = K_{pr}$ and $B_1 = B_2 = B$. The optimum values of these parameters have been calculated using genetic algorithm and particle swarm optimization algorithm. Equations of two objective functions (ISE and ITAE) used are given below:

$$ISE = \int_0^{80} (\Delta F_1^2 + \Delta F_2^2 + \Delta P_{tie}^2) dt \quad (6)$$

$$ITAE = \int_0^{80} t(|\Delta F_1| + |\Delta F_2| + |\Delta P_{tie}|) dt \quad (7)$$

VI. RESULTS AND DISCUSSION

A digital simulation of the system was performed using MATLAB (/Simulink) over a time period of 80 seconds, for each individual (particle) of the current population. The simulation is performed by considering 1% load perturbation in thermal area only. The value of objective function is calculated and then next population is produced using optimization algorithm. The procedure is repeated till maximum number of generations (iterations) is reached or algorithm converges to a optimum value. Table I shows different parameters of GA and PSO, used for simulation.

The optimization process is repeated 4 times for each of combination namely, using ISE and GA, using ITAE and GA, using ISE and PSO and using ITAE and PSO. From these four sets, results with more number of occurrences are shown in Table II and Table III. Table II shows the results using ISE and ITAE with GA and Table III shows the results using ISE and ITAE with PSO. It may be noted that the higher values of ITAE is due to multiplication of time factor as indicated in (6) and (7) above, and it doesn't in any way ascertain a poor response. The actual responses are given in the plots and discussed in the coming sections.

Once the optimized parameters are obtained as above, the same were used in the model of Fig. 3. Simulation runs were carried out with these values in order to compare the responses obtained by GA and PSO with both the objective functions (ISE and ITAE). The performance of AGC is determined in terms of variation in frequency of all the areas and also the variation in agreed tie line flow;

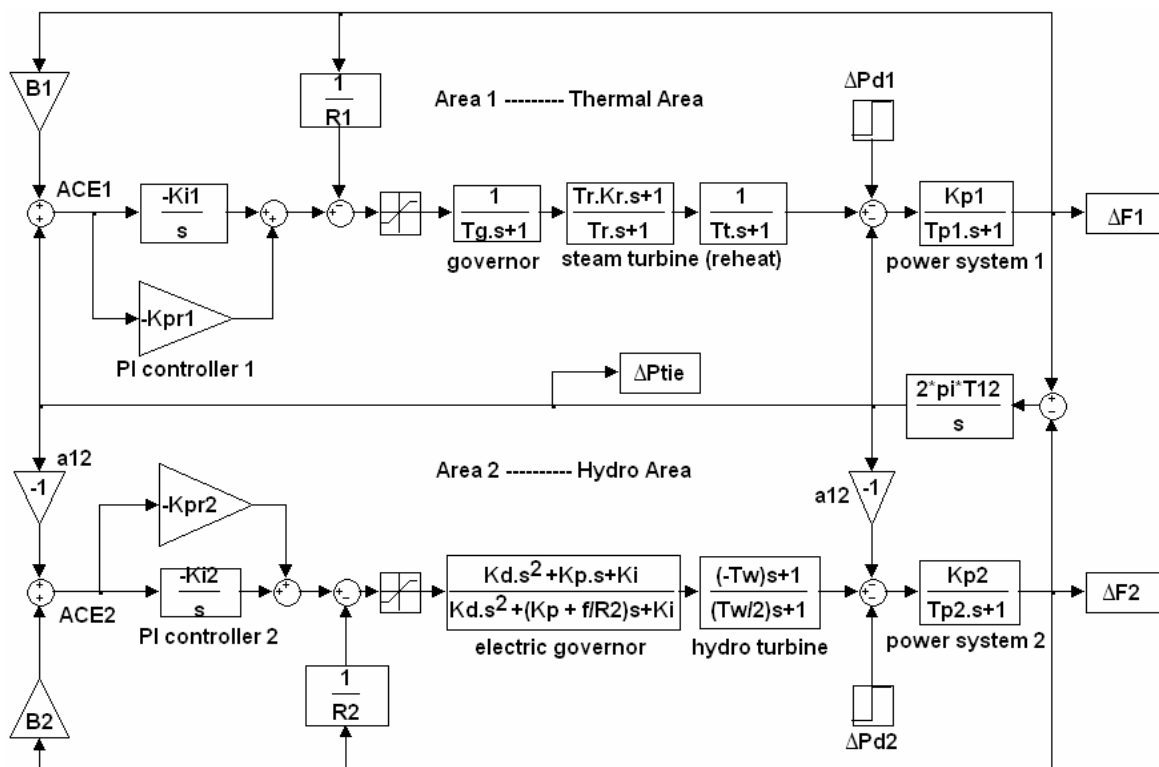

Fig. 3 transfer function model of the interconnected hydrothermal system

TABLE I
 PARAMETERS USED FOR GA AND PSO

GA Parameters	PSO Parameters
Population size: 20	Population size: 20
Max. number of generations: 120	Max. number of iterations: 200
Crossover fraction: 0.8	c1 = 2.0
Mutation fraction: 0.1	c2 = 2.0
Reproduction probability: 0.1	

TABLE II
 OPTIMAL VALUES OF PARAMETERS USING GENETIC ALGORITHM

	Ki	Kpr	B	Objective function
ISE	0.086456	0.15106	0.82538	0.0042
ITAE	0.16547	0.22926	0.40252	2.1623

TABLE III
 OPTIMAL VALUES OF PARAMETERS USING PARTICLE SWARM ALGORITHM

	Ki	Kpr	B	Objective function
ISE	0.1097	0.2043	0.57628	0.0043
ITAE	0.21127	0.28878	0.20523	2.4356

the responses below compare the same for both hydro and thermal areas. Figs. 4 to 6 give the response obtained with GA with 1% load perturbation in the thermal area; while Figs. 7 to 9 give the relative performance with PSO for the same case of load perturbation with both the objective functions. As obvious from these results, the performance of AGC is better when the objective function used is ITAE as compared with ISE for most of the cases. Although simulation was performed for 80 seconds, graphs are shown for first 60 seconds for clarity. As it can be observed from these results, when ISE is used as objective function oscillations don't die out soon and remain for longer time. In case of ITAE, however, we get improved damping, though the settling time is almost of the same order.

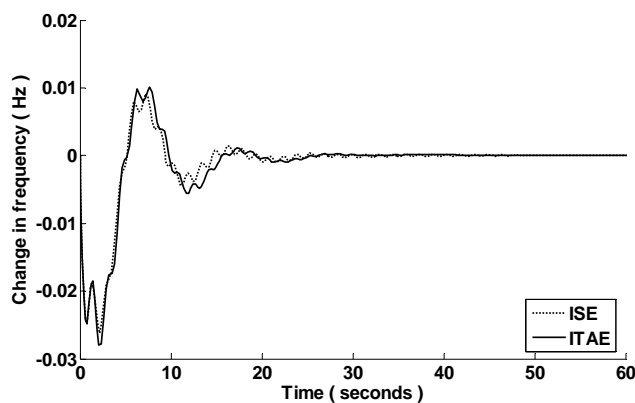

Fig. 4 frequency change in thermal area (using GA)

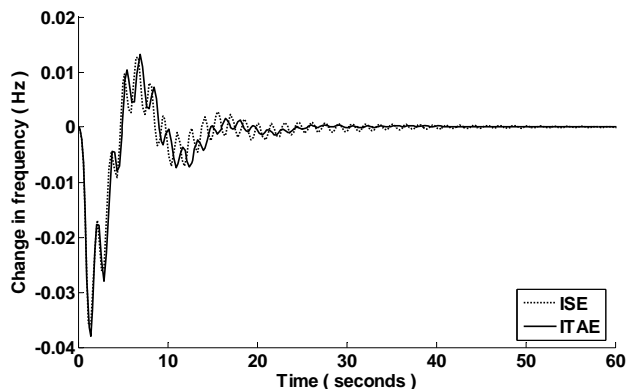

Fig. 5 frequency change in hydro area (using GA)

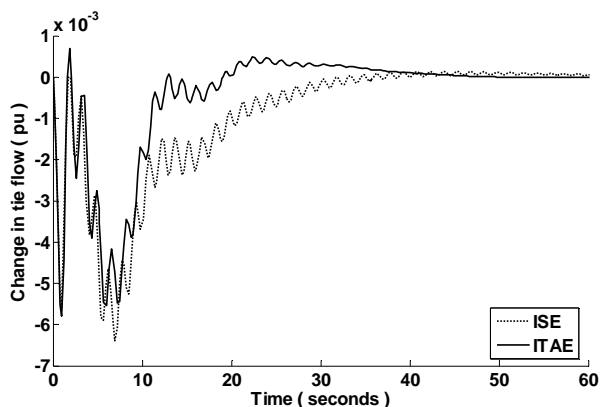

Fig. 6 change in tie line power flow (using GA)

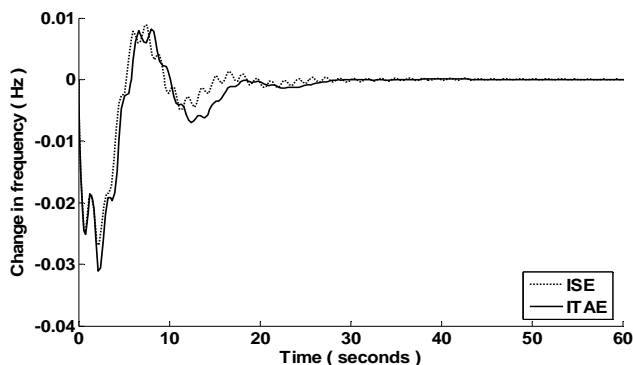

Fig. 7 frequency change in thermal area (using PSO)

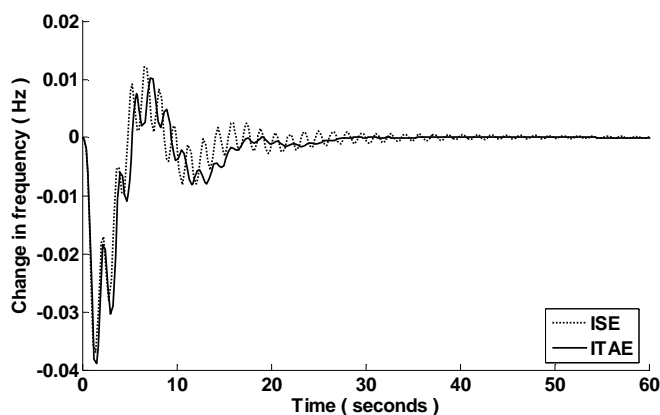

Fig. 8 frequency change in hydro area (using PSO)

Figs. 10 to 12 compare genetic algorithm and particle swarm optimization algorithm. As it was observed that ITAE is better objective function than ISE; therefore comparison between GA and PSO is now done by using ITAE alone as objective function. From these results it can be seen that the results obtained from both GA and PSO are compatible. It can also be observed that genetic algorithm gives better frequency response. As verified by Table II and Table III, the respective objective function values are less in the case of genetic algorithm.

The previous section gives the comparison of GA Vs PSO; and the results in both the cases are found very close to each other. Nevertheless, if typical un-optimized values of B, Ki and Kpr are taken (as given in Appendix); then the system responses differ significantly. Figs. 13 to 15 compare the optimized response with un-optimized response. As it has been already observed that GA together with ITAE gives best results, therefore they are used for comparing with un-optimized response. It can be seen from these results that optimized response is much better than un-optimized one.

In Fig.16 Fitness value is plotted against Number of generations when optimized by GA. It was observed that all the population converges to a single value and thus confirms the reliability of results obtained using GA. The best value of the fitness function (/objective function i.e. ITAE) comes out to be 2.0914 and their mean is 28.0378 over 120 generations. The best value of optimization parameters is also shown in the other half of the figure.

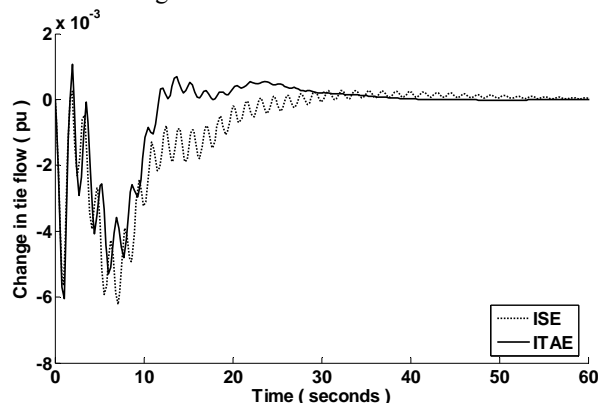

Fig. 9 change in tie line power flow (using PSO)

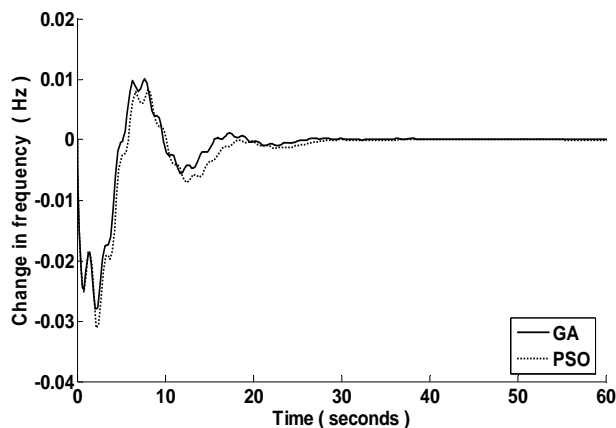

Fig. 10 frequency change in thermal area (using ITAE)

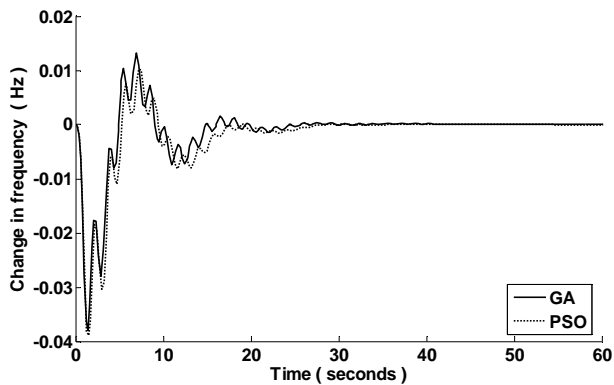

Fig. 11 Frequency change in hydro area (using ITAE)

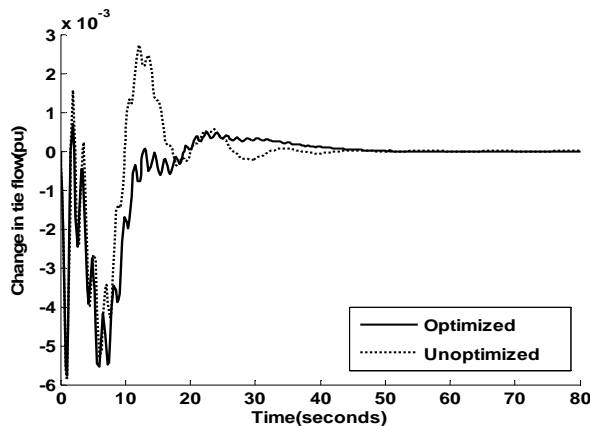

Fig. 15 change in tie line power flow

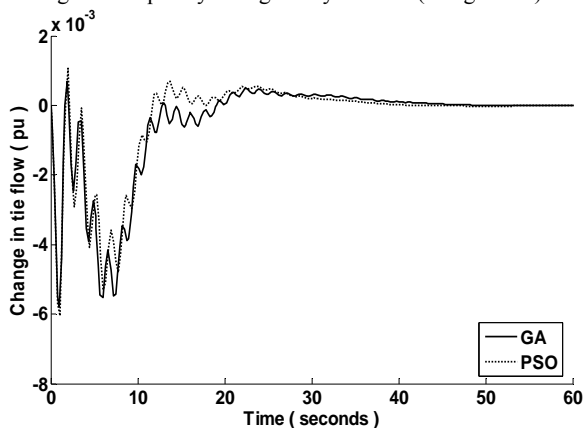

Fig. 12 change in tie line power flow (using ITAE)

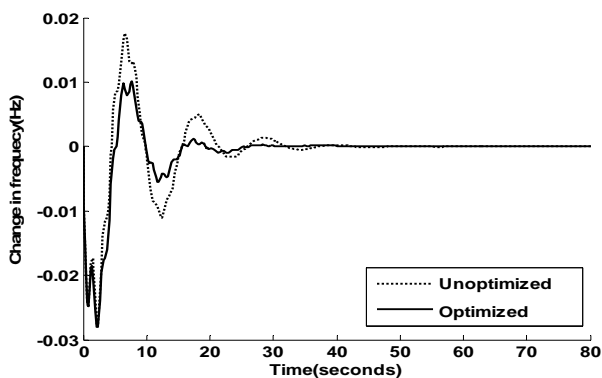

Fig. 13 frequency change in thermal area

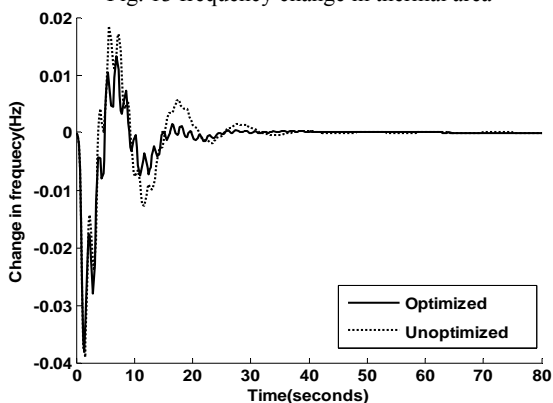

Fig. 14 frequency change in hydro area

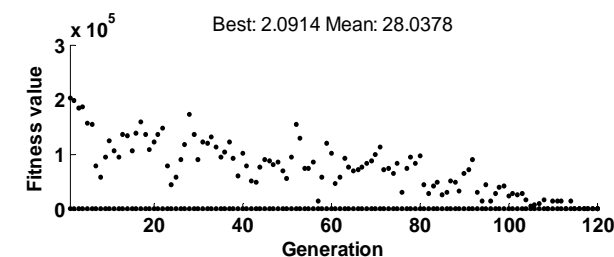
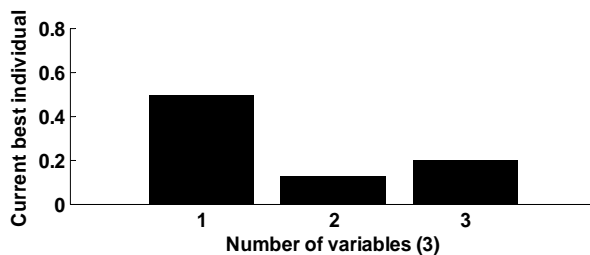

Fig. 16 fitness value v/s generations (using GA)



VII. CONCLUSIONS

This work compares two different optimization algorithms (GA and PSO) and two objective functions (namely ISE and ITAE), for the parameters of an interconnected two area system. It is found that parameters obtained by using ITAE as objective function, give response in which oscillations and variation in tie line power flow are lesser. Subsequently, optimization algorithms using GA and PSO are compared with ITAE as an objective function. It is found that the responses obtained by the two algorithms are comparable. Yet, GA gives a better frequency response than that obtained with PSO. It was also noted that the optimized response either with GA or PSO, differ significantly compared to an un-optimized response with typical values of AGC parameters. The future extension of this work can be in studying the comparative performance of various AI techniques for larger (multi-area) systems with variegated values of parameters. In addition, simultaneous disturbance in all the areas concerned can also be considered.

APPENDIX

Nominal parameters of hydrothermal system investigated:

$f = 60$ Hz	$D_1 = D_2 = 8.33 \times 10^{-3}$ p.u. MW/ Hz
$T_g = 0.08$ sec	$R_1 = R_2 = 2.4$ Hz/p.u. MW
$T_r = 10.0$ sec	$T_t = 0.3$ sec
$H_1 = H_2 = 5$ sec	$K_p = 1.0$
$P_{r1} = P_{r2} = 2000$ MW	$K_d = 4.0$
$P_{tie, max} = 200$ MW	$K_i = 5.0$
$K_r = 0.5$	$T_w = 1.0$ sec

REFERENCES

- [1] J. J. Grefenstette, "Optimization of control parameters for genetics algorithms," *IEEE Trans. Systems, Man and Cybernetics*, SMC-16, No. 1, Feb. 1986.
- [2] J. L. Willems, "Sensitivity analysis of the optimum performance of conventional load frequency control," *IEEE Trans. Power Apparatus and system*, vol. 93, pp. 1287-1291, 1974.
- [3] K. De Jong, "Adaptive system design: a genetic approach," *IEEE Trans. Systems, Man and Cybernetics*, SMC-10, No. 9, pp. 1566-574, Sept. 1980.
- [4] O. E. Elgerd, *Electrical Energy Systems Theory* (2nd ed.), New York: McGraw-Hill Inc., 1982, pp. 315-389.
- [5] P. J. Fleming and C. M. Fonseca, "Genetic algorithms in control systems engineering," Research Report No. 470, *Dept. of Automatic control and Systems Engineering, University of Sheffield*, Sheffield, U.K., March 1993.
- [6] P. Kundur, *Power System Stability and Control*, New York: McGraw-Hill, 1994.
- [7] R. C. Eberhart and Y. Shi, "Particle swarm optimization: developments, applications and resources," *Proceedings of the IEEE Congress on Evolutionary Computation (CEC 2001)*, Seoul, Korea, 2001, pp. 81-86.
- [8] R. Eberhart and J. Kennedy, "Particle swarm optimization", *Proceedings of the IEEE International Conference on Neural Networks*, Perth, Australia, December 1995.
- [9] W. C. Schultz, and V. C. Rideout, "Control system performance measures: Past, present, and future," *IRE Trans. Automatic Control*, vol. 22, No. 6, pp. 22-35, 1961.
- [10] Y. L. Abdel-Magid and M. M. Dawoud, "Tuning of AGC of interconnected reheat thermal systems with genetic algorithms", *IEEE International Conference on Systems, Man and Cybernetics*, Vancouver, BC, vol. 3, 1995, pp. 2622 – 2627.
- [11] Y. L. Abdel-Magid and M. A. Abido, "AGC tuning of interconnected reheat thermal systems with particle swarm optimization", *Proc. 10th IEEE International Conference on Electronics, Circuits and Systems, ICECS*, vol. 1, 2003, pp. 376- 379.
- [12] S. P. Ghoshal, "Application of GA/GA-SA based fuzzy automatic generation control of a multi-area thermal generating system", *Electric Power Systems Research*, vol. 70, Issue 2, pp. 115-127, July 2004.
- [13] SimPowerSystems User guide. Available: <http://www.mathworks.com>

R. N. Patel did his Ph. D. in the area of Power Systems from the Indian Institute of Technology (IIT) Delhi in the year 2003. Prior to this he obtained his postgraduate from IIT Delhi and graduate degree from SGSITS Indore in Electrical Engineering in the year 1997. His main fields of interest have been power system stability, optimization in electric power systems, application of AI techniques, design of intelligent controllers and modeling & simulation.

Apart from being associated with IIT Delhi as a research scholar, he has served at IIT Roorkee in the capacity of Lecturer from the year 2003 to 2006. He has also worked for the Birla Institute of Technology and Science, Pilani for a short span of six months during the year 2003. Presently he is working with the department of Electrical and Electronics Engineering at SSCET, Bhilai. Dr. Patel has 18 publications in various international journals of repute and more than 20 papers in various international conferences.