

Left Ventricular Model Using Second Order Electromechanical Coupling: Effects of Viscoelastic Damping

Elie H. Karam, and Antoine B. Abche

Abstract—It is known that the heart interacts with and adapts to its venous and arterial loading conditions. Various experimental studies and modeling approaches have been developed to investigate the underlying mechanisms. This paper presents a model of the left ventricle derived based on nonlinear stress-length myocardial characteristics integrated over truncated ellipsoidal geometry, and second-order dynamic mechanism for the excitation-contraction coupling system. The results of the model presented here describe the effects of the viscoelastic damping element of the electromechanical coupling system on the hemodynamic response. Different heart rates are considered to study the pacing effects on the performance of the left-ventricle against constant preload and afterload conditions under various damping conditions. The results indicate that the pacing process of the left ventricle has to take into account, among other things, the viscoelastic damping conditions of the myofilament excitation-contraction process.

Keywords—Myocardial sarcomere, cardiac pump, excitation-contraction coupling, viscoelasticity

I. INTRODUCTION

DIFFERENT approaches have been followed in the modeling of the left-ventricular pump. Some of these approaches are: lumped time-varying elastance [1], finite element [2], and geometric integration of muscle characteristics [3], [4], [5]. The original model of our work [3], [4] has been built from serial and parallel arrangement of sarcomere units. Each sarcomere unit consists of parallel active and passive elements that were described by nonlinear stress-length functions. The myocardial functions were integrated over a cylindrical geometry of the structure to obtain the global left ventricular function. Time-variation was introduced via a lumped periodic excitation-contraction coupling mechanism of the myocardial fibers. The cardiovascular lumped system consisting of the left ventricular model with its venous preload and arterial load was used to study left ventricular hemodynamics, energetics, and physiological hypertrophy for varying chronic load conditions.

II. DERIVATION OF THE MODIFIED MODEL

In this work, a new relationship between ventricular pressure and volume is derived from myocardial properties

Manuscript received October 9, 2001.

E. H. Karam is with the University of Balamand. P.O.Box 100, Tripoli, LEBANON (phone: 961-6930250; fax: 961-6930238; email: elie.karam@balamand.edu.lb)

A. B. Abche is with the University of Balamand. P.O.Box 100, Tripoli, LEBANON (email: antoine.abche@balamand.edu.lb)

integrated over a truncated ellipsoidal geometry. The myocardial sarcomere is the essential force producing element in the heart. It consists of a parallel arrangement of actin and myosin fibrils (Fig.1). The Ca^{++} concentration ($[Ca^{++}]$) controls the longitudinal force produced by these fibers in the process known as the excitation-contraction coupling mechanism [6].

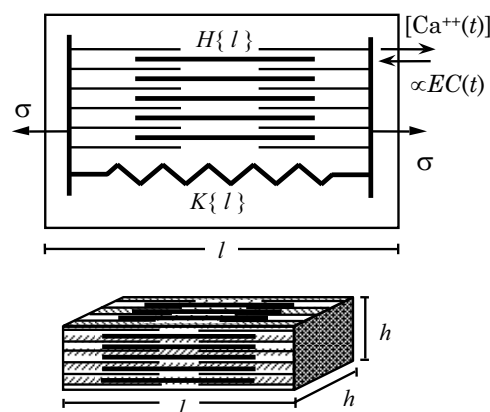

Fig. 1 Model of the cardiac sarcomere unit. Upper drawing: functional structure consisting of the actin-myosin sliding filaments and an elastic element due to elastin and collagen connective mesh. Lower drawing represents a rectangular volume unit which embodies the sarcomere structure and prescribes the dimensions of the element

Experiments have been performed to obtain the function of the sarcomere. For example, the time development of muscle force (Fig.2a) originates from the periodic increase (release) and decrease (uptake) in $[Ca^{++}]$. The peak muscle force is found to increase with increasing muscle length (Fig.2b) i.e., the Starling law for muscle [7]. A maximum force occurs at an optimal length, thought to be the position of optimal fiber overlap.

The model of the sarcomere unit consists of two basic elements: active contractile and passive elastic elements, arranged in parallel (Fig.1). The active element provides the force-generating mechanism, while the passive component imparts the stiffness to the sarcomere. The level of force produced by the contractile unit model is determined by the excitation-contraction coupling mechanism, which is a function of the time-varying $[Ca^{++}]$ and muscle contractility.

This function is responsible for the shape of the isometric muscle force curve (Fig.2a). This is indicated in Figure 1 by a time-varying level of $[Ca^{++}]$ in a volume surrounding the sarcomere unit. The level of the force produced is modulated by the length of the contractile unit at any given time, according to the Starling law (Fig.2b).

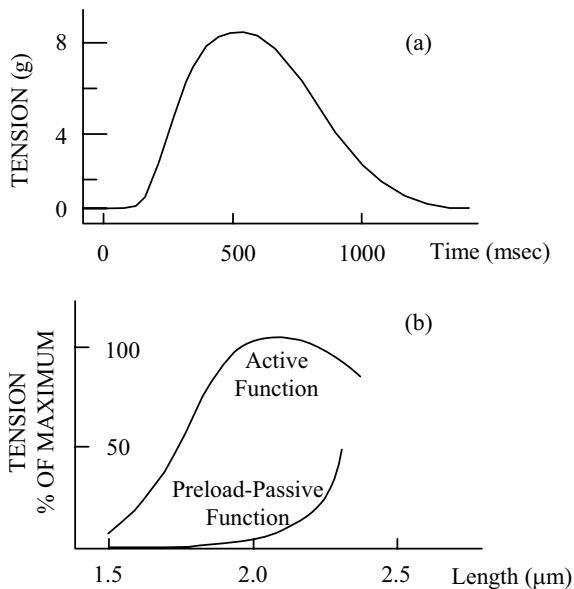

Fig. 2 (a) The time dependent isometric myocardial force (Modified from [11]). (b) Active and passive cardiac muscle force-length curves [Modified from [12]].

The sarcomere model can be transformed into its proper mathematical form. Normalization of the measured tension by the peak isometric tension yields the time-dependent normal muscle stress, $EC(t)$, known as the excitation-contraction function. The time-varying shape of the $EC(t)$ function is assumed to be independent of length.

For isovolumic beats, it has been found that the time-dependence of ventricular pressure can be represented by a sinusoid [8]. However, this function was not apparently sufficient, and an exponential decay function, for example, has been added to the sinusoidal function [13].

In the current work, the excitation-contraction function is derived using a second order dynamic system approach (fig. 3a). The system consists of $[Ca^{++}]$ activation-deactivation periodic function, $E_{in}(t)$, that serves as an input (stimulus) to a second order electromechanical system. The stimulus is represented by different constant activation and deactivation rates. The response of the system is a normalized excitation-contraction function, $EC(t)$. The second order system is conceived from the process of filament mass acceleration in the viscoelastic medium of the contractile element (fig. 3b).

The Starling stress-length relationship of a muscle unit (Fig.2b) is defined as the general function $H\{l-l_a\}$, where l is

the actual muscle length and l_a is the minimal muscle length at which the active stress drops to zero. The active stress, $\sigma_a\{t, l\}$, developed by a given myofibril can be written as a product of the excitation-contraction function and the modulating Hill relation,

$$\sigma_a\{t, l\} = EC(t) \cdot H\{l-l_a\} \quad (1)$$

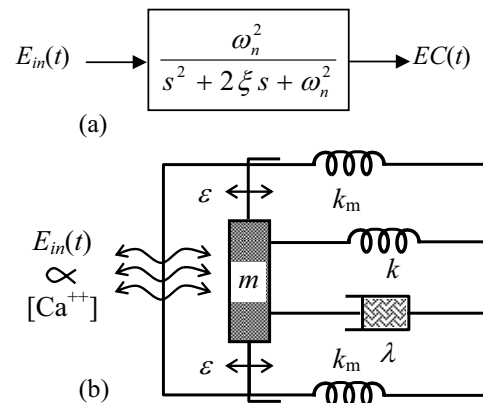

Fig. 3 (a) Second-order dynamic system used to model the excitation-contraction process. (b) Electrochemical-mechanical structure used to derive the excitation-contraction function. The parameters used represent the following: ϵ \equiv relative change in sarcomere length; k, λ \equiv viscoelastic coefficients of the sarcomere inner structure; k_m \equiv elastic coefficient of the filament membrane; and $E_{in}(t) \propto [Ca^{++}]$ represents the electrochemical stimulation-calcium flow process.

The functions in (Eq.1) have been measured for different animals and are available in the literature [9]. The most appropriate relationship for the active stress-length function of the muscle is not clear, since linearity has been mostly applied. However, muscle physiology dictates that nonlinear function must apply. For lack of the true stress-length function, a second-order polynomial was assumed for $H\{l-l_a\}$ to proceed with the analysis.

$$H\{l-l_a\} = a(l-l_a)^2 + b(l-l_a) \quad (2)$$

where a and b are constants that can be evaluated from muscle data.

The stress developed by the passive fibers of the sarcomere unit is, by definition, independent of time. This passive stress can be measured when the active elements are not stimulated (Fig.2b) and has been found to be primarily a function of the muscle length. Thus, the passive sarcomere unit behaves as a spring with a nonlinear elastic response and is defined by a general function $K\{l-l_0\}$, where l_0 is the resting length or zero-stress length. This function can be analytically represented, or replaced with the proper muscle data obtained from the literature.

The passive stretch of muscle has been shown to follow an exponential stress-length relationship ([10]. In our work, a nonlinear muscle stress-length law was incorporated, where

$K\{l-l_0\}$ has been represented by an exponential function in terms of the length l .

$$K\{l-l_0\} = \alpha\{\exp[\beta(l-l_0)] - 1\} \quad (3)$$

where, α and β are empirical constants determined from muscle data.

Finally, the total stress developed by the contractile unit model can be obtained as

$$\sigma\{t, l\} = EC(t) \cdot H\{l-l_a\} + K\{l-l_0\} \quad (4)$$

A 3-D array of myocardial units that has been previously arranged into a cylindrical geometry [3], [4] is now replaced by a truncated ellipsoidal geometry chosen to represent the structure of the ventricle (Fig.4) in the derivation of the new nonlinear pressure-volume function.

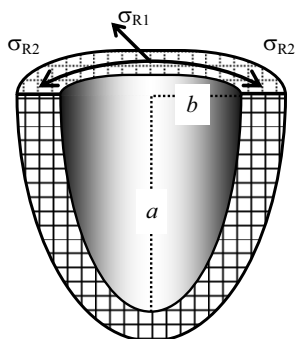

Fig. 4 A truncated ellipsoid, representing the shape of the left ventricle, where “ a ” is the major semi-axis, “ b ” is minor semi-axis, and “ σ_{R1} ” and “ σ_{R2} ” are the longitudinal and circumferential stresses, respectively.

By combining geometric functions with stress-length and stress-pressure relationships, the global left-ventricular pressure-volume is obtained, i.e.,

$$P(t) = P_g(t, V) + P_c(V) \quad (5)$$

In equation 5, $P_g(t, V)$ and $P_c(V)$ represent the nonlinear active and passive pressure-volume characteristics of the left ventricle, respectively.

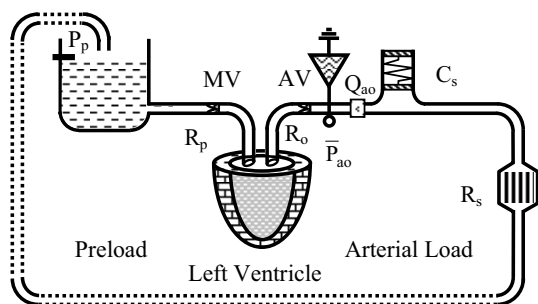

Fig. 5 Prototype model of the cardiovascular system. The left ventricle ellipsoid model is connected to the preload and the afterload models of the cardiovascular system. Here, \bar{P}_{ao} is the value of the

mean aortic pressure to which the left ventricle is adjusting (not implemented in this paper).

In our model, the lumped left ventricle-systemic circulation consists of three compartments: venous preload, left ventricle, and arterial load. The left ventricle is the central compartment of this system. It receives blood from the preload compartment during the filling phase and pumps it to the arterial load during the contraction phase. This pump has the characteristics described earlier. In the prototype model (Fig. 5), the left ventricle is shown as an ellipsoid connected to the preload and arterial load models. In the equivalent analog circuit (Fig.6), the left ventricle is represented by the active pressure (voltage) source, $P_g(t, V)$, in series with the passive elastic element, $P_c(V)$, that were derived earlier.

The actual physiological preload to the left ventricle has been lumped, since the interaction among its various compartments is not a subject of this work. This lumped preload system is represented in the physical prototype model (Fig.5) by a filling reservoir connected to the left ventricle via a resistive tube. The pressure of the fluid in the filling reservoir represents the mean filling pressure, P_p , of the left ventricle. The resistance of the filling tube, R_p , represents the lumped value of the flow resistance of the pulmonary venous return and inflow tract.

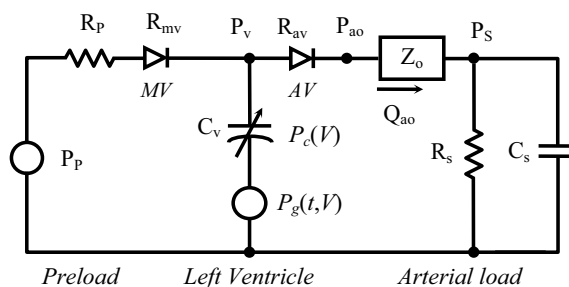

Fig. 6 Analog circuit representing the proposed model of the left ventricle connected to the preload and afterload counterparts of the cardiovascular system (see text for details).

The arterial load system represents the arterial system, from the root aorta up to systemic vasculature. In the prototype and analog equivalent circuit (Figs. 5 and 6), the arterial load is represented by the modified Windkessel model consisting of the impedance at the root aorta, Z_o , the total systemic compliance, C_s , and the total peripheral resistance, R_s . The system equations obtained from the analog model (Fig. 6) are:

$$\frac{dP_c}{dt} = f_1\{P_p, P_v, P_s, C_v, t\} \quad (6)$$

$$\frac{dP_s}{dt} = f_2\{P_p, P_v, P_s, C_s, t\} \quad (7)$$

Here, R_{mv} and R_{av} represent valve resistances, which are functions of the pressure gradient across them. The system response is obtained by numerical computational technique, using Newton-Raphson root-solving and fourth-order Runge-Kutta integration algorithms. Thus, the instantaneous values of the ventricular volume and pressure, and systemic pressure can be determined. Then, the corresponding mitral flow (Q_m), aortic flow (Q_{ao}), aortic pressure (P_{ao}), stroke volume (SV), end-diastolic volume (EDV), end-systolic volume (ESV), cardiac output (CO), and ejection fraction (EF) are computed.

III. RESULTS

The effects of the viscoelastic damping conditions on the hemodynamic response of paced left ventricle are examined with this model. The hemodynamic response of the modified excitation-contraction system is shown below for a range of damping ratio, ζ (zeta) values and fixed heart rate.

The pressure and volume waveforms obtained from the model are shown in Figure 7, with the left-ventricular P-V loops. The results indicate that the damping element of the electromechanical excitation-contraction process has significant effects on the pressure and volume waveforms. Low values of the damping ratio, ζ , lead to very fast blood ejection and oscillation in the LV systolic pressure. The diastolic phase is also affected by low values of ζ , where pressure oscillations and phase filling of different rates are observed. As the damping ratio increases, the oscillations in systolic pressure disappear, while the ejection rate becomes slower, extending a little longer in time, with slow ejection rate occurring toward the end of the ejection interval. As the damping ratio is further increased, the isovolumic contraction interval increases, leading to a decrease of the end-diastolic volume under constant rate of left-ventricular pacing conditions.

The effects on the pressure and volume waveforms are reflected onto the pressure-volume loop. As the viscoelastic damping ratio is increased, the P-V loop is reduced with lower end-diastolic volume and lower pressure during ejection. However, it can be observed that the end-diastolic volume did not change significantly for ζ between 0.3 and 1.1. Also, the ejection at lower values of ζ occurs at a faster rate compared to that at higher values of ζ . A reduced P-V loop area suggests lower work performed by the left ventricle. It is important to indicate here that this change in the value of ζ is applied at a constant heart rate (HR) value of 75 beats/min and without any compensation mechanism. In the actual cardiovascular system, the effect of the viscoelastic damping element would interact with short-term and long-term regulation and compensation mechanisms.

In Figure 8, the effects of ζ are examined for different values of HR. In general, the effects of increased value of ζ appear to be more intensified at higher HR levels. The hemodynamic response variables shown are end-diastolic volume (EDV), ejection fraction (EF), cardiac output (CO), and mean systemic pressure (MAP).

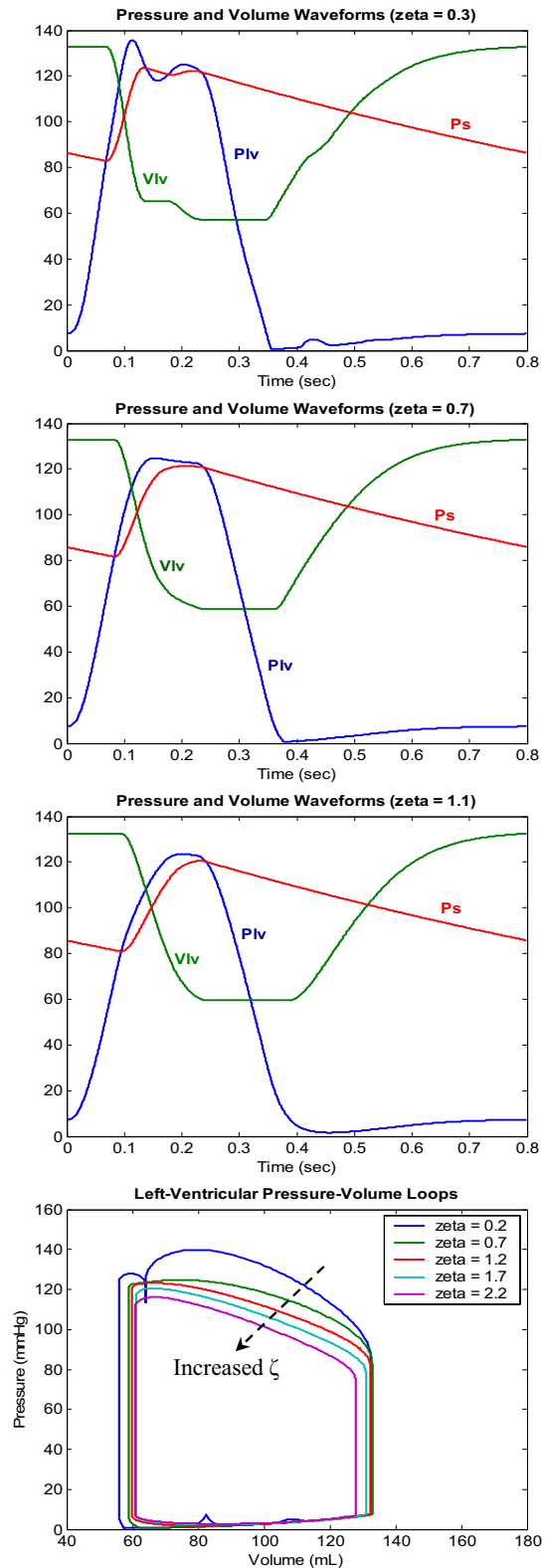

Fig. 7 LV pressure (Plv), systemic pressure (Psys), LV volume (Vlv), and pressure-volume loops for damping ratio 0.3, 0.7, and 1.1

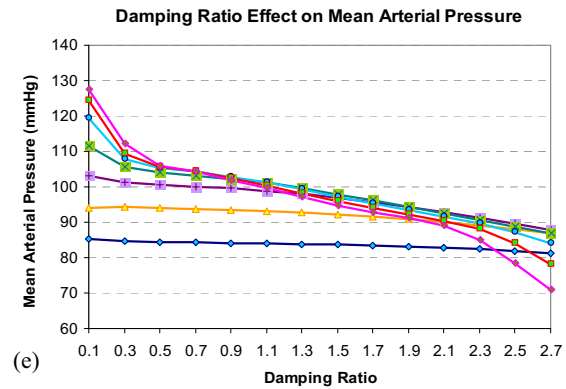
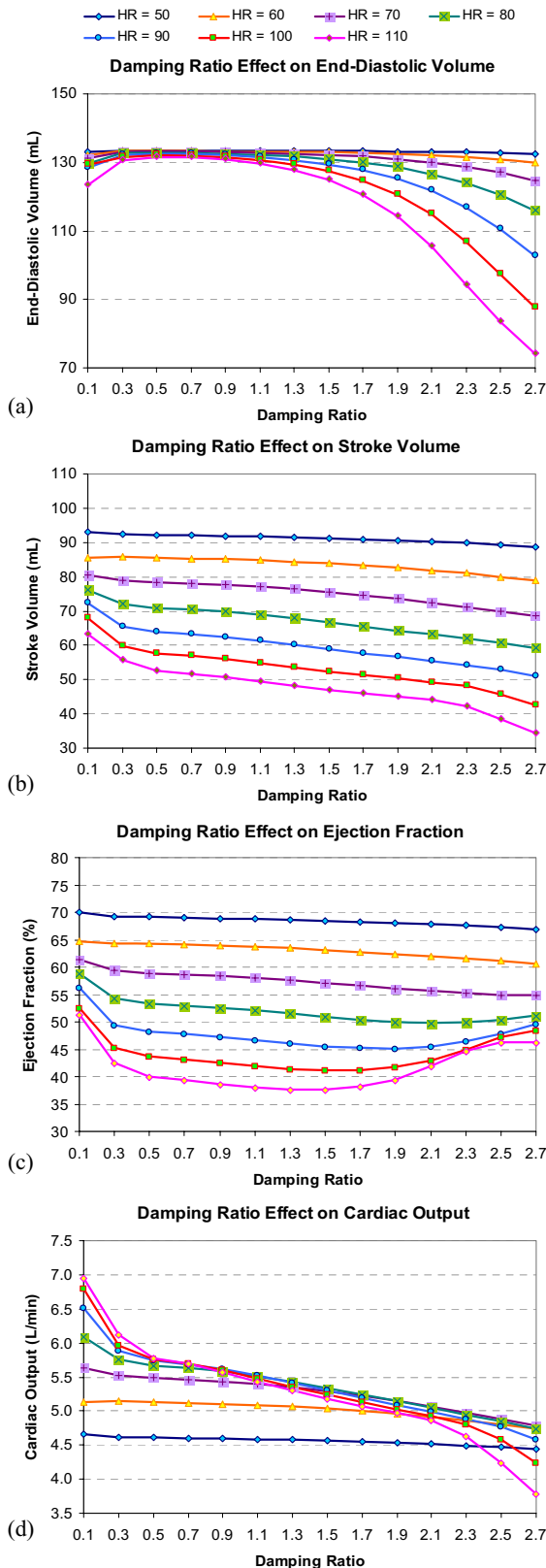

Fig. 8 Hemodynamic response variable variations with variation of damping ratio in the range 0.1 to 2.3

The EDV curves (Fig.8a) indicate that at high HR and high values of ζ , the EDV is significantly reduced. This reduction cannot be attributed to HR alone or ζ alone. In fact, at low HR values (between 50 and 60 beats/min), EDV is relatively independent of ζ . And over some range of ζ (0.4 to 0.8 for the case here), different HR values result in very small changes in EDV. High values of HR imply less time for filling, yet this phenomenon is intensified at high viscoelastic damping ratio conditions.

While a ζ range exists over which HR-induced variations in EDV are not significant, this is not the case for SV (Fig.8b) which seems to be highly affected by the variations of ζ and HR. At low HR values the SV undergoes a small decrease with ζ . The results show that the slope of decrease in SV with ζ gets larger at higher HR values. It can be observed also that at high HR and large damping, the decrease in SV starts to take a sharper drop.

The combined effects of HR and ζ on the EDV and SV extend onto the EF or the ratio of SV over EDV. In general, EF decreases with ζ . The decrease is small at low HR levels, and it becomes more significant at higher levels of HR. The small increase in EDV at low range of ζ combined with the decrease in SV results in decrease of EF (Fig.8c). On the other hand, the EDV drops significantly in the upper range of ζ at high HR values, whereas the SV drop over this range is rather linear. This is reflected in the observed increase in EF at the upper range of ζ for the high HR values.

Now, while the SV is generally lower at high HR, the reduction in SV is compensated for by the HR when it comes to the estimation of CO (Fig.8d). Thus the CO levels are generally higher at high HR values. In general, the CO decrease over the range of ζ becomes more significant as HR level is increased. It can be observed that as the viscous damping gets larger, the HR compensation becomes less effective in indication of the higher energy losses and lower output, therefore lower efficiency.

The variations in CO over the range of ζ and at different HR levels have high degree of correlation with those in the MAP (Fig.8e). This shows that, while the model is highly nonlinear and pulsatile, the well known relationship among

MAP, CO, and total peripheral resistance (TPR), kept fixed in this case, is still holding here, i.e.,

$$\text{MAP (mmHg)} = \text{CO (mL/sec)} \times \text{TPR (mmHg-sec/mL)}.$$

In fact, the TPR is calculated for each value of zeta at different HR conditions. The results are shown in Fig.9. The actual value of systemic resistance used in the model simulation is 1.10 mmHg-sec/mL. A small deviation (about 2%) in the calculated value of TPR relative to the actual value is observed at high HR and large damping.

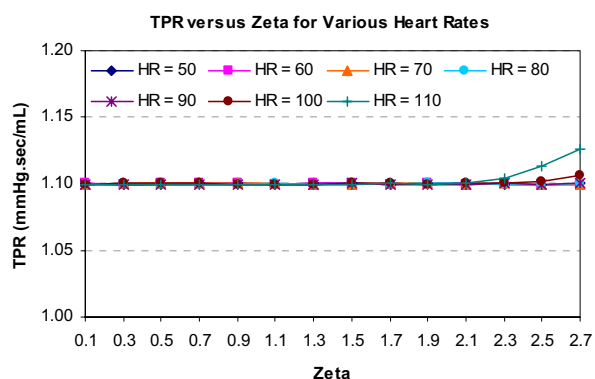

Fig. 9 TPR values calculated from MAP and CO results for each value of zeta at different HR conditions; the actual value of systemic resistance used in the model simulation is 1.10 mmHg-sec/mL

IV. CONCLUSION

In the current approach of left ventricular pump model, the modifications introduced attempted to separately model the time-excitation and the length- and shape-modulated periodic contraction mechanisms of the left-ventricular pump. We have combined at the level of the basic muscle unit a second-order viscoelastic time-excitation into nonlinear stress-length muscle characteristics in order to numerically generate the hemodynamic response of the left ventricle. While such complexity has been avoided in lumped and some other modeling approaches, this approach provides an alternative to explore and examine a wider variety of cases, and the individual effects of the various components of the system, mainly at the level of muscle building unit.

The hemodynamic response of the model presented for the case considered agrees with physiological findings. This response depends on the specific values of the stress-length function parameters, as well as on the geometric dimensions of the left ventricle. This is so due to high level of interdependence between the time-variance and nonlinearity of the system. However, the amount of information one can draw from the numerical computation of this model for various cases is worth the time and effort. The results also show that the nonlinearity of this pulsatile model and the viscoelastic damping ratio of the excitation-contraction coupling mechanism did not alter the well established steady-state relationship among the mean systemic pressure, the cardiac output, and the total peripheral resistance.

REFERENCES

- [1] H. Suga, "Theoretical analysis of a left-ventricular pumping model based on the systolic time-varying pressure/volume ratio." *IEEE Trans. Biomed. Eng.*, 18(1): 47-55, 1971.
- [2] R. Dong, Y. Sun, F. J. Fetter, and S. A. Chiaramida, "Time-varying left-ventricular elastance determined by finite element model." Proceedings of the IEEE 30th Annual Northeast Bioengineering Conference, 188-189, 2004.
- [3] G. M. Drzewiecki, E. Karam, and W. Welkowitz, "Physiological Basis for Mechanical Time-Variance in the Heart: Special Consideration of Non-Linear Function." *J. Theor. Biol.*, 465-486, 1989.
- [4] E. Karam, "Modeling of Cardiac Growth and Hypertrophy-Regulating Factors." Ph.D. Thesis. Rutgers, The State University of New Jersey, 1992.
- [5] E. Karam, A. Abche, and G. M. Drzewiecki, "Left Ventricular Hypertrophy Model Revisited." BIOMEDSIM, University of Balamand, Lebanon, 2003.
- [6] G. A. Langer, "Ion fluxes in cardiac excitation and contraction and their relation to myocardial contractility." *Phys. Rev.*, 48: 708-757, 1968.
- [7] E. Sonnenblick, D. Spiro, and H. M. Spotnitz, "The ultrastructural basis of Starling's law of the heart. The role of the sarcomere in determining ventricular size and stroke volume." *Am. Heart J.*, 68: 336, 1964.
- [8] K. Sunagawa, A. Yamada, Y. Senda, Y. Kikuchi, T. Nakamura, T. Shibahara, and Y. Nose, "Estimation of the hydromotive source pressure from ejecting beats of the left ventricle." *IEEE Trans. Biomed. Eng.*, 27: 299-305, 1980.
- [9] H.E.D.J. Ter Keurs, W. H. Rijnsburger, van Heuningen, M. J. Najelsmit, "Tension development and sarcomere length in rat cardiac taberculae: Evidence of length-dependent activation." In : *Cardiac Dynamics*. Baan, J., A. C. Arntzenius, and E. L. Yellin (eds.), Martinus Nijhoff Publishers, Boston, 1980.
- [10] I. Mirsky, and W. M. Parmley, "Assessment of passive elastic stiffness for isolated heart muscle and intact heart." *Circ. Res.*, 33: 233-243, 1973.
- [11] W. M. Parmley, D. L. Brutsaert, and E. H. Sonnenblick, "Effects of altered loading on contractile events in isolated cat papillary muscle." *Circ. Res.*, 24: 521-532, 1969.
- [12] J. Ross, Jr., E. H. Sonnenblick, J. W. Covell, G. A. Kaiser, and D. Spiro, "Architecture of the heart in systole and diastole: Technique of rapid fixation and analysis of left ventricular geometry." *Circ. Res.*, 21: 409-421, 1967.
- [13] T. Ihara, Y. Yamada, and K. Komamura, "Hemodynamic determinants of left ventricular diastolic function: A model study." 18th Annual Conf. of IEEE EMBS, Amsteram, 1996.