

# A Review on Natural Fibre Reinforced Polymer Composites

C. W. Nguong, S. N. B. Lee, and D. Sujan

**Abstract**—Renewable natural fibres such as oil palm, flax, and pineapple leaf can be utilized to obtain new high performance polymer materials. The reuse of waste natural fibres as reinforcement for polymer is a sustainable option to the environment. However, due to its high hydroxyl content of cellulose, natural fibres are susceptible to absorb water that affects the composite mechanical properties adversely. Research found that Nano materials such as Nano Silica Carbide (n-SiC) and Nano Clay can be added into the polymer composite to overcome this problem by enhancing its mechanical properties in wet condition. The addition of Nano material improves the tensile and wear properties, flexural stress-strain behaviour, fracture toughness, and fracture strength of polymer natural composites in wet and dry conditions.

**Keywords**—Natural fibres, Nano Silica Carbide, Nano Clay, Wet Condition, Polymer Composites.

## I. INTRODUCTION

PLASTIC industry ranks third in the world amongst all other industry. According to a report from the Society of the Plastic Industry, almost \$400 billion annual sales were reported in United States alone [1]. Plastic which plays a supporting role to other industry is generally polymers, and used in daily applications such as automotive, manufacturing, packaging, building construction, home utilities, and the list moves on.

As the popularity of plastic booming, the environmentalists continue to raise concern regarding the potential destruction that would be caused by the increasing number of disposal of plastics. In this decade, there is a serious concern towards research and implementation of biopolymers. These polymers are biodegradable and are harmless upon disposal. Nowadays petroleum based polymers are most commonly utilized and these plastics are expected to fully decompose in thousands of years. However, in 2008, a 16years old Canadian boy, Daniel Burd was able to decompose a petroleum-based plastic bag in 3 months. In order to isolate the bacteria that would decompose the plastic bag, the mixed landfill dirt with yeast and tap water. The only by-product of the reaction was carbon dioxide and water [1]. Thus, with more research and advancement in technology, plastic shall one day no longer be a threat to the environment.

Natural fibres in substitution of conventional glass fibres as reinforcement are major steps taken in promoting

environmental sustainability. There are many types of natural cellulose fibre such as flax, hemp, sisal, banana, kenaf, jute and oil palm fruit bunch cellulose fibre. South East Asia, Indonesia and Malaysia in particular, being top producers of palm oil, have problems in disposing the empty fruit bunch cellulose fibres and therefore, it is of interest to convert the waste into useful reinforcement. Advantages of natural fibres as plastic reinforcement are due to its low density, renewability, biodegradability, non-toxicity, good insulation property and machine wear. The low density of natural fibres is very beneficial in the automotive industry. A study has been carried out which, shows that when 30% of glass fibres is substituted with 65% of hemp fibres, the net energy saving of 50,000MJ (3 tons of emission) can be achieved [2]. However, the drawbacks of natural fibres are due to its poor wettability, high moisture absorption, and incapability with some of the polymeric matrices. The moisture absorption which is due to hydrophilic property of natural fibres adversely affects the mechanical properties such as flexural strength, flexural modulus and fracture toughness.

Nano-Silicon Carbide had received a considerably significant attention in industry due to its excellent properties which improved physical, thermal, and mechanical properties of material. It is often used as in reinforcement in matrix. Nano particles, due to its smaller particles size, enhance mechanical properties in matrix. In addition, Nano silicon carbide is expected to enhance the moisture barrier, wear, thermal and mechanical properties in wet conditions.

In this paper, a review of epoxy composites reinforced with various reinforcements such as natural fibres and silicon carbide is studied. The paper emphasizes on palm oil fruit bunch cellulose fibres as the natural reinforcement. Silicon Carbide is studied as reinforcement in enhancing the mechanical properties of polymer composites.

## II. ENVIRONMENTAL SUSTAINABILITY

According to [2], the use of high density glass ( $2.5 \text{ g/cm}^3$ ) as polymer composites in automobile production will increase the specific weight of polymer matrix. It can produce negative environmental impact in terms of energy consumption. Moreover, [2] also stated that the disadvantage of glass fibres is its end life disposal where approximately up to 50% of volume remains as unburned residues. Since 1990 the researchers for automotive companies had explored that natural fibre is more environmental friendly compared to traditional glass fibre reinforcement due to its low density, low cost and fundamentally biodegradable.

Reference [2] also shown the life cycle assessment (LCA) of transport pallets made of polypropylene (PP) with china reed fibre with the LCA of the same PP pallets reinforced with glass fibres. According to the results obtained, the PP pallets

C. W. Nguong is with the Curtin University Sarawak, Miri, Malaysia (phone: 0060168926239; e-mail: Ry.c88@hotmail.com).

S. N. B. Lee is with the Curtin University Sarawak, Miri, Malaysia (phone: 0060168561137; e-mail: samuel.n.b.l@gmail.com).

D. Sujan is with the Curtin University Sarawak, Miri, Malaysia (phone: 0060128535426; e-mail: d.sujan@curtin.edu.my).

with natural fibre-reinforcement (NFR) shows lower environmental impacts compared to PP pallets with glass fibre reinforced (GFR). As conclusion, PP pallets with natural fibre reinforcement is more environmentally friendly and provided much greater lifetime compared with glass fibre reinforced.

Besides, it also described the environmental impact of carbon storage potential of a specific moulded component for automotive industry made of polypropylene reinforced with hemp or glass fibres. According to the results obtained, 50,000 MJ (about 3 tons of CO<sub>2</sub> emissions) of net energy were saved after 30% by weight of glass fibres replaced with hemp fibres. Furthermore, it also shows that 21% weight was reduced for Polypropylene (PP) reinforced with hemp compared with Polypropylene (PP) reinforced with glass fibre. It shows an approximation around 3.07 million tons of CO<sub>2</sub> emissions (4.3% of total US industrial emissions) and 1.19 million cubic meter of crude oil could be saved if natural composites would substitute 50% of glass fibre plastic used in North America for Automotive applications [2].

### III. CHEMICAL COMPOSITION OF NATURAL FIBER

As stated by [3], natural fibres have complicated structures which are normally rigid, with crystalline cellulose micro fibril-reinforced amorphous lignin and/or with hemi cellulose matrix. Furthermore, natural fibres (except cotton) are generally composed of cellulose, hemicellulose, lignin, waxes, and some water-soluble compounds, where cellulose, hemicelluloses, and lignin are the major constituents. Natural fibres generally contain 60-80% of cellulose, 5-20% lignin and moisture up to 20%. The surface of cell wall of natural fibres will experience pyrolysis when the processing temperature increases. Pyrolysis process is a chemical decomposition of organic material at high temperature with

TABLE I  
CHEMICAL COMPOSITION, MOISTURE CONTENT AND MICROFIBRILLAR ANGLE OF VEGETABLE FIBRES [3]

Fibre	Cellulose (Wt%)	Hemicellulose (Wt%)	Lignin (Wt%)	Pectin (Wt%)	Moisture (Wt%)	Waxes	Microfibrillar Angle (Deg)
Flax	71	19.6	2.2	2.3	10	1.7	5-10
Hemp	72	20.1	4.7	0.9	9	0.8	2.6-2
Jute	66	17	12.5	0.2	13	0.5	8
Kenaf	51	21.5	10.5	3-5			
Sisal	73	12	12	10	16	2	16
Henequen	78	4-8	13.1				
PALF	76		8.85	11.8			14
Banana	64	10	5	11			
Abaca	59		12.5	1	8		
Oil Palm EFB	65		19				42
Oil Palm Mesocarp	60		11				46
Cotton	88	5.7		0-1	8	0.6	-
Cereal	42	23	16	8			
Straw							

the absence of oxygen. The process involves chemical composition and physical phase changes. Pyrolysis will contribute a layer called charred layer that will help to insulate lignocelluloses for further thermal degradation [3]. Table I represents the approximate chemical composition, moisture content and microfibrillar angle of selected vegetable fibres.

### IV. TYPES OF NATURAL FIBER

Natural fibres can be divided into animal fibres and plant cellulose fibres. Plants that produce natural fibres are categorized into primary and secondary depending on the utilization. Primary plants are grown for their fibres while secondary plants are plants where the fibres are extracted from the waste product. There are 6 major types of fibres namely; bast fibres, leaf fibres, fruit fibres, grass fibres, straw fibres and other types (wood and roots etc.). There are thousands of natural fibres available and therefore there are many research interests in utilization of natural fibres to improve the properties of composites [4]. Recycled cellulose fibres are obtained from cellulosic waste products such as paper, newspaper, cardboard and magazine. Fig 1 shows the classification of natural fibres.

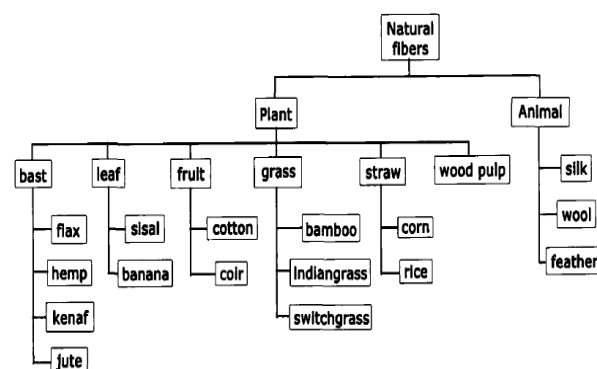

Fig. 1 Classification of natural fibres [2]

### V. POTENTIAL PLANT FIBERS

**Flax:** Flax, *Linum usitatissimum*, which is under the bast fibres is grown in temperate regions and is one of the oldest fibre crop ever. It is commonly used in composite area and in higher value-added textile markets.

**Hemp:** Hemp is another important member of bast fibres from the *Cannabis* family. Like flax, it is also grown in temperate region. Hemp receives considerable attention as it is currently subject to European Union subsidy for non-food agriculture and is of interest for more development in Europe.

**Jute:** Jute of genus *Corchorus* that is bast fibres with the highest production volume is the cheapest natural fibres. Countries such as Bangladesh, India, and China provide the best condition for the growth of jute.

**Kenaf:** Kenaf of genus *Hibiscus* have about 300 species and is a new crop in United States which shows good potential for usage as reinforcement in composite products. Latest

innovation in decortications separates core from the bast fibres combined fibre shortages, have gained the interest of utilizing kenaf as fibre source.

**Sisal:** Sisal, *Agave sisalana*, is commercially produced in East Africa and Brazil. The global demand for sisal fibre and its products is predicted to decrease between 1998-2000 and 2010 by a yearly rate of 2.3% as agricultural twine. The traditional market continues to decline by substitution of synthetic substitutes and implementation of harvesting technology that uses small amount or no twine.

**Abaca:** Abaca or banana fibre that is extracted from the banana plant is durable and resistant to seawater. Abaca being the strongest commercially available cellulose fibres is the native plant of Philippines and is produced in Philippines and Ecuador. In the past, it is the chosen cordage fibre for marine applications due to its superior properties.

**Pineapple leaf fibre:** Pineapple, *Ananas Comosus*, is a tropical plant indigenous of Brazil. It is rich in cellulose fibres and the leaf fibres are waste product that are relatively cheap and are of a concern for polymer reinforcement.

**Oil Palm:** Oil palms, is vastly produced in South East Asia, particularly in Malaysia and Indonesia. Oil palm empty fruit bunch cellulose fibres are referred as relatively cheap or waste product in the industry and therefore, it is of interest to utilize the cellulose fibres into beneficial products with higher commercial value. It is studied that, oil palm empty fruit bunch have the potential as plastic reinforcement.

#### VI. DISADVANTAGE OF NATURAL FIBER

According to some sources, [2], [3], [5], & [6], common major drawbacks of utilizing natural fibre is its high hydroxyl content of cellulose which makes it susceptible to absorb water and consequently affects the mechanical properties of composites adversely. As mentioned by Ray and Rout [9], this is the natural behaviour of hydrophilic fibres. It also explained that water molecules will tend to attract to hydrophilic groups of fibres and reacts with hydroxyl group (-OH) of the cellulose molecules to form hydrogen bonds. The schematic of moisture absorption by natural fibres from Ray and Rout is attached in Fig. 2 below.

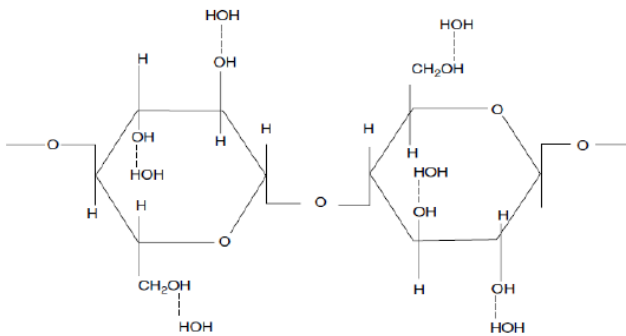

Fig. 2 Schematic of moisture absorption by natural fibre [6]

Furthermore, there is possibility that the attracted water might form another layer on the top water molecules that previously absorbed. The attracted water will act as a separating agent in fibre-matrix interface illustrated in Fig. 3. In this case, separation between fibre and resin will happen. The evaporation of moisture may happen during the process and will influence the porosity in the matrix [6].

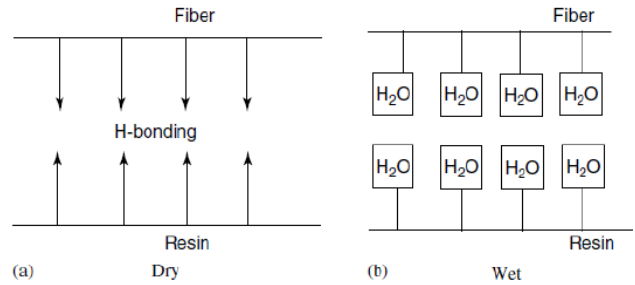

Fig. 3: a) H-bonding between fibre and resin in dry condition  
 b) water acts as separating layer that leads to separation between fibre and resin in wet condition [6]

Reference [6] stated that due to the natural moisture of atmosphere the absorption and desorption of natural fibre can cause swelling in wet environment and shrinkage in dry environment. Due to this, natural fibre will show poor mechanical properties. Therefore, [6] stated that drying process for natural fibre is also important.

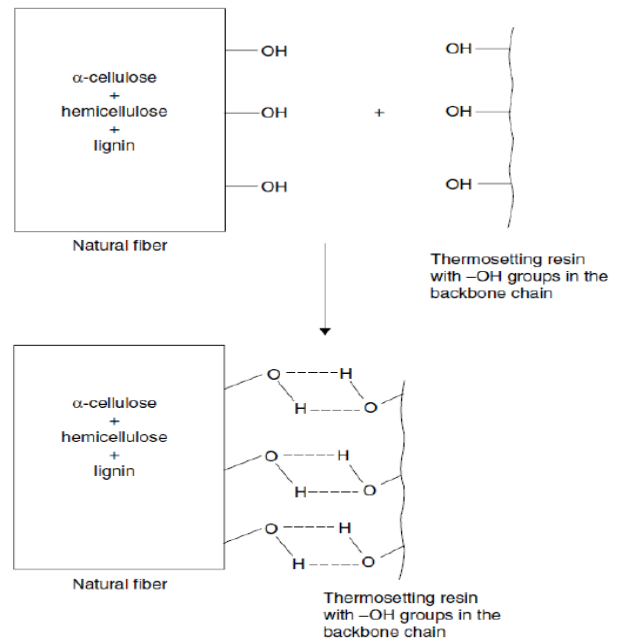

Fig. 4 Formation of hydrogen bonds between hydroxyl groups of natural fibre [6]

Moreover, the three important factors that will affect the hydrogen bonding include mechanical anchoring, physical molecular attractive force (Van der Waals force and hydrogen bond) and chemical bonds between fibre and resin. Hydrogen bonding is formed between the reaction of hydroxyl groups (-OH) in the main backbone chain of resin and natural fibre

(Fig. 4). Consequently, resin with no hydroxyl group in the backbone chain will have the weakest bonding because strong hydrogen bond does not form, hence it will show low adhesive properties [6].

Research work by Alamri and Low [7] shows that the mechanical properties such as flexural strength, flexural modulus, fracture toughness and impact strength increase with the increases of cellulose fibre contained as reinforcement. On the other hand, it also tested that the values of maximum water diffusion coefficient increase with the increases of fibre content. Fibre loadings of 19, 28, 40 and 46 wt% were used for different testing specimens.

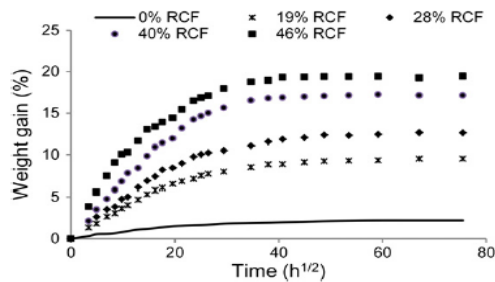

Fig. 5 Water Absorption curves of Recycled Cellulose / epoxy composites [7]

According to Fig. 5, the water absorption increases with the increase of recycled cellulose fibre content (RCF) due to hydrophilic nature of cellulose fibres.

Several papers were found regarding to the methods of overcoming the issue of natural fibre moisture absorption. Alamri and Low [5] had made a further research in another research paper to find the solution to deal with water absorption for natural fibre reinforced epoxy. In their research, Nano Silica Carbide n-SiC is added to observe the effect on water absorption of n-SiC reinforced RCF/epoxy composites. The author verified that the addition of n-SiC will eventually decrease the water uptake and enhance the mechanical properties of the polymer.

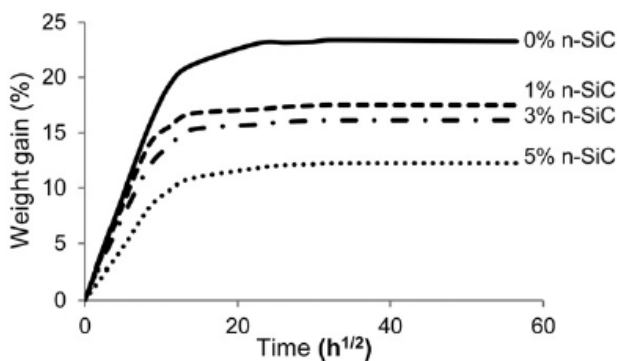

Fig. 6 Water Absorption curves of n-SiC filled RCF/epoxy eco-nanocomposites [5]

From Fig. 6 it can be observed that the high content of Nano particle decrease water uptake of the specimen and exhibit low value of weight gain [5].

According to [8], it added Nano clay into sisal reinforced epoxy composites to test its water barrier properties. The polymer composites without and with different weight percentage (1wt%, 3wt% and 5wt %) of Nano clay were tested. The results show dramatic decrease in water mass uptake of Nano clay filled composites.

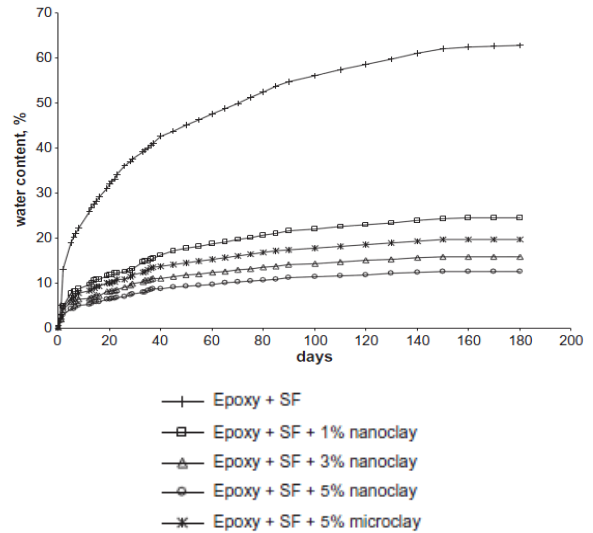

Fig. 7 Water uptake of unfilled and clay filled composite series [8]

Fig. 7 from [8] demonstrates the water uptake curves of clay filled and unfilled composites series. It shows that the water uptake of unfilled composite was more than clay filled composites. Equilibrium water content continuously decrease as Nano clay content increase and maximum reduction was observed for 5% wt. micro clay filled composite. Reference [8] also explained that clay Nano layer creates an impermeable medium to arrest the water flow and cause the water to take an indirect path and hence more time is needed for water uptake. This can result in decrease in equilibrium water content in Nano clay filled composite system [8]. All of the equilibrium water content value for each specimen is illustrated in Table II.

TABLE II  
 WATER UPTAKE CHARACTERISTIC OF UNFILLED AND CLAY FILLED COMPOSITE SERIES [8]

Material	Diffusivity (mm <sup>2</sup> /s)	Equilibrium water content (%)
Epoxy +SF	$2.08 \times 10^{-7}$	62.1
Epoxy +SF +1% nanoclay	$2.07 \times 10^{-7}$	24.3
Epoxy +SF +3% nanoclay	$2.40 \times 10^{-7}$	15.8
Epoxy +SF +5% nanoclay	$2.31 \times 10^{-7}$	12.5
Epoxy +SF +5% microclay	$2.36 \times 10^{-7}$	19.6

## VII. MECHANICAL PROPERTIES OF NATURAL FIBER REINFORCED POLYMER COMPOSITES

Reference [9] shows that enhancement of flexural strength (45.6%), fracture toughness (30%), were achieved by 1 wt % nanoclay with recycled cellulose fibers and epoxy eco-composites. Conversely, with more addition of nanoclay, no

improvements in these properties due to increased voids, viscosity and poor dispersion. It is also investigated that for the case of epoxy/RCF composites, the presence of RCF as reinforcement material greatly increased flexural strength (160%), fracture toughness (263%), compared to pure epoxy. The significant enhancement is clarified by the cellulose fibre's capability in withstanding bending and resisting fracture force. The addition of Nano-clay to RCF/epoxy is said to be insignificant for enhancement of flexural strength and fracture toughness. Furthermore, Epoxy eco-composites were reinforced with n-SiC and recycled cellulose paper (RCF). The reinforcement of 1 wt. % n-SiC into epoxy resin enhanced the flexural strength, flexural modulus and fracture toughness. However, with higher increment of n-SiC, flexural strength decline due to poor dispersion of n-SiC particles and formation of particle agglomerations at high filler content [10].

Through some research, flexural strength, flexural modulus and fracture toughness was found to decrease with water absorption affected by degradation of bonding at the fibre-matrix interfaces. The increased fibre content promotes higher water absorption [7].

Reference [11] stated that the fracture toughness decreased by 22.2% when epoxy composites is reinforced with banana pseudo-stem fibre reinforcement while fracture toughness increased by 15.7% with coconut reinforcement and 17.8% with sugar cane bagasse reinforcement. This shows that not all natural fibres would increase the fracture toughness of polymer matrix composites.

#### A. Tensile Properties

According to experimentation conducted by Mohan and Kanny [8], it shows that Nano clay or micro clay in the composite changed the stress strain patterns (Fig. 8). The modulus continuously increased as Nano clay content increased. Reference [8] also stated that the addition of Nano

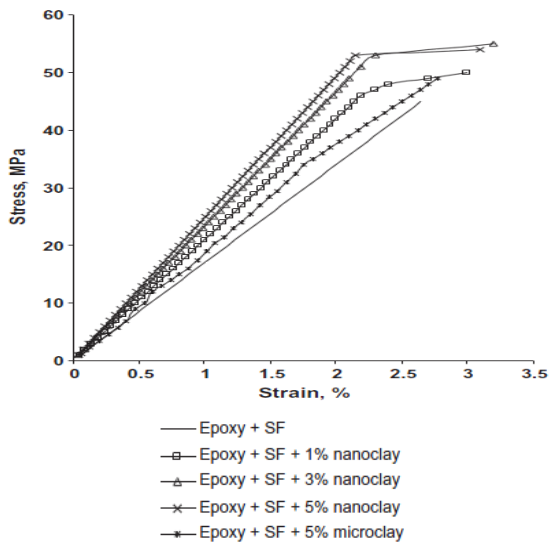

Fig. 8 Tensile Stress Strain Curves of Unfilled and Clay Filled Composite Series before Placing in Water [8]

clay in composites changes the failure pattern from brittle to ductile failure. This is because Nano clay acts as crack arrestor during loading by inducing deformation mechanisms such as crack pinning and debonding which results in specimen failing under deformed condition [8].

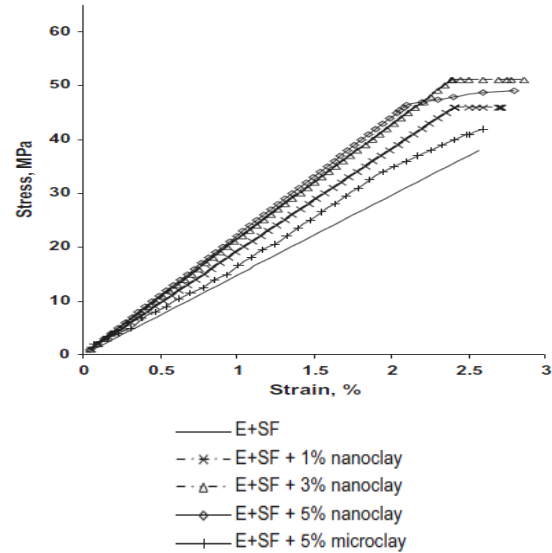

Fig. 9 Tensile Stress Strain Curves of Unfilled and Clay Filled Composite Series after Placing in Water [8]

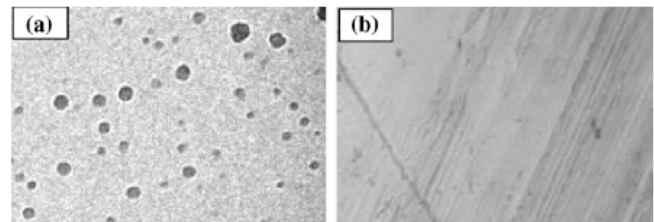

Fig. 10 SEM picture of 5 wt.% clay filled composite (a) before (b) and after degassing [8]

According to Fig. 10, the cross section of 5% wt. Nano clay filled composite shows the existence of voids before degassing. Degassing is a process used to free the unwanted air in a material. According to [8], hardener is added after the mixing of Nano clay resin to ensure no air is trapped inside the solution. The voids actually allow more water uptake into the specimen.

#### B. Wear Properties

TABLE III

WEAR PROPERTIES OF UNFILLED AND CLAY FILLED COMPOSITE SERIES [8]

Material	Before placing in water % weight loss	After placing in water % weight loss
Epoxy +SF	11	15
Epoxy +SF +1% nanoclay	9	13
Epoxy +SF +3% nanoclay	8	11
Epoxy +SF +5% nanoclay	6	9
Epoxy +SF +5% microclay	9	13

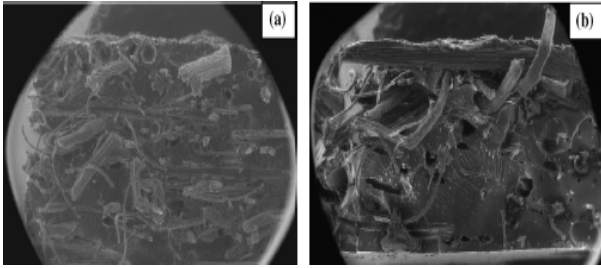

Fig. 11 SEM pictures of wear surface of unfilled composite (a) before and (b) after placing in water [8]

According to [8], the weight loss is due to the increase of wear properties for the specimen placed in water. As from Table III, Nano clay filled composites give better wear properties compared to unfilled and micro clay filled properties. As conclusion, the addition of Nano clay improves the wear properties of the composites material. Fig. 11 shows the wear surface of unfilled composites before and after place in water. The matrix interphase and bonding of composite is better before placing in water. After it placed in water, it shows debonding of fibres and weak fibre-matrix interphase. The wear properties of the composite will reduce in this situation.

#### C. Flexural Stress- Strain Behaviour

According to research conducted by [7], a stress- strain curve of two different percentages of recycled cellulose (RCF) filled composites specimen 19 wt. % and 46 wt. % are used to check its flexural behaviour. The graph plotted is illustrated in Fig. 12.

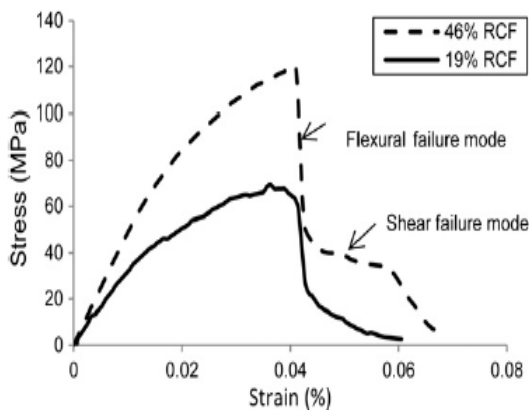

Fig. 12 Stress- Strain Curves of Recycled Cellulose Fiber (RCF) epoxy composites filled with 19 and 46 wt% [7]

According to Fig. 12, it shows that composites filled with low RCF loading showed a low strain (0.003%) and low stress that caused material failure. On the other hand, the reduction in modulus occurs for low RCF. As for high percentage content of RCF, it shows a linear behaviour at higher strain (0.013%) and the slope reduction until the failure of composites occurs in higher stress value [7].

In another work by [5], where n-SiC was added to investigate the effect of water absorption on mechanical properties of recycled cellulose fibre reinforced epoxy. The

flexural stress-strain curve for unfilled RCF/epoxy and 5wt% n-SiC filled RCF/epoxy before and after placing in water is illustrated in Fig. 13.

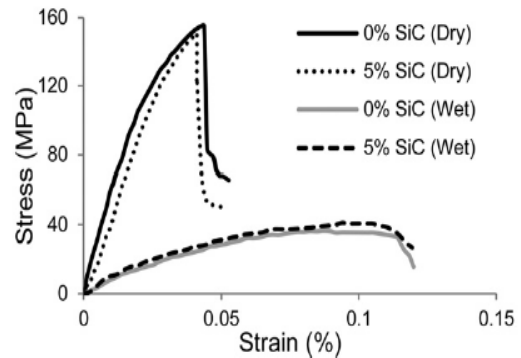

Fig. 13 Stress-strain curves of RCF/epoxy filled with 0 and 5 wt% n-SiC in dry and wet conditions

According to Fig. 13, the addition of n-SiC particle decreased in the maximum stress of RCF/epoxy for dry condition. However, the addition of n-SiC in wet condition showed increase of maximum stress. The flexural properties decreased due to water absorption, damaged and degradation in fibre-matrix interfacial bonding. Moreover, the maximum strain was found increased due to the water absorption [5]. As research found from [12] and [13], water molecules will act as plasticizer agent for reinforced fiber to increase the ductility of the specimen by increasing the maximum strain.

#### D. Fracture Toughness

According to [7], the relationship of fracture toughness of dry and wet Recycled cellulose fibre (RCF) epoxy is illustrated in Fig. 14.

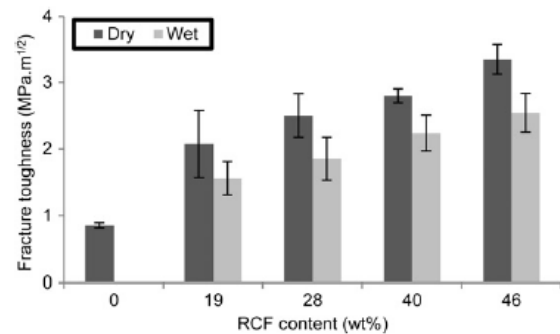

Fig. 14 Effect of fiber content on fracture toughness of dry and wet RCF/epoxy composites [7]

From Fig. 14, the addition of recycled cellulose fibre increased the value of fracture toughness compared to the neat epoxy specimen because higher RCF content will have higher extensive pull outs, fracture and bridging [7]. Besides, the fracture toughness of 46% wt. RCF content increased up to 294.1% compared to the neat epoxy. As for the effect of water absorption, the fracture toughness generally decreased due to the moisture absorption but there was still an upward trend in



fracture toughness for wet condition as the RCF content increased. This is also due to pull outs, fracture and bridging to increase the crack propagation resistance [7].

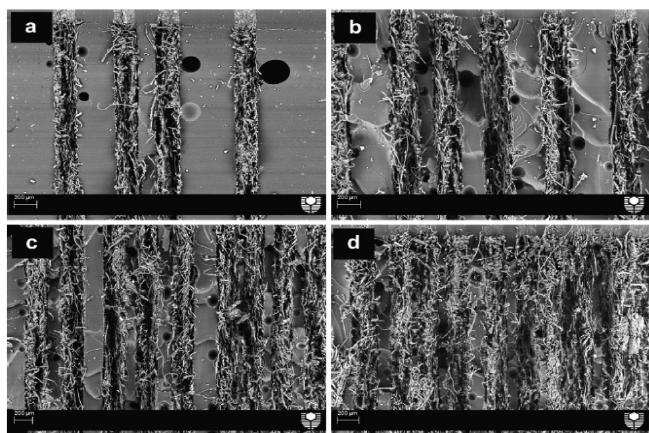

Fig. 15 SEM images of fracture surface of different content of RCF/epoxy composites (a)19wt% (b)28wt% (c)40wt% (d) 46wt% [7]

According to Fig. 15, the RCF content with lower fibre content (19 and 28) wt. % showed high rich matrix compared to (c) and (d) with lower matrix. High rich matrix region means region with less reinforcement. As stated by [7], increase in matrix-rich regions will not be restrained by enough fibres. Therefore, there is no sufficient amount of fibre to carry the load from the matrix. Due to this reason low content of fibre exhibits low fracture toughness, low stresses and poor mechanical properties [7].

In another research paper [4], n-SiC was added to observe the effect of water absorption on mechanical properties of recycled cellulose fibre reinforced epoxy. The relationship for n-SiC filled RCF/epoxy composites on fracture toughness is illustrated in Fig. 16.

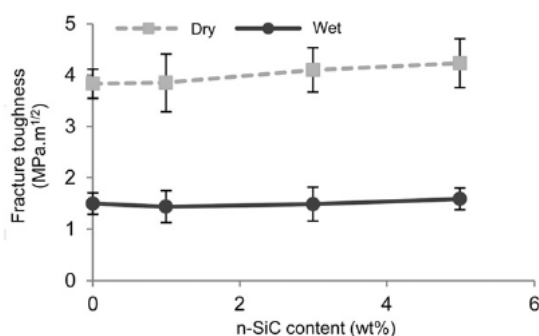

Fig. 16 Fracture Toughness of n-SiC filled RCF/epoxy eco-Nano composites for dry and wet conditions [4]

According to Fig. 16, the fracture toughness for all wet conditions was decreased compared to the dry conditions. This is because damage in fibre structure and interfacial bonding between fibre and matrix [4]. According to [12], once the water is absorbed, it causes swelling in fibres and creates micro cracks and causes de-bonding and weakening fibre matrix interface. As for the effect of n-SiC, it showed that the

addition of n-SiC increased the value of fracture toughness. In other words, it increased the crack propagation resistance and enhanced the mechanical properties [5].

## VIII. CONCLUSION

Natural polymer composites are more environmental friendly compared to polymer composites with synthetic fibres reinforced. Advantages of natural fibres as plastic reinforcement are due to its low density, renewability, biodegradability, non-toxicity, good insulation property and machine wear. Natural fibre contains high hydroxyl content of cellulose that makes it susceptible to water absorption that affects the materials mechanical properties. However, Nano materials such as Nano Silica Carbide (n-SiC) and Nano Clay can be added into the natural fibre reinforced polymer composite to overcome the water absorption problem.

## ACKNOWLEDGEMENT

The Authors are grateful to the R&D Department, Curtin University Sarawak for financial support to conduct this research work under CSCRF scheme (Cost Centre No: 5004)

## REFERENCES

- [1] Cantor, Kirk M., and Patrick Watts. 2011. "Introduction to the Plastics Industry." In *Applied Plastics Engineering Handbook*, ed. Kutz Myer, xv-xvi. Oxford: William Andrew Publishing.
- [2] Zini, E.; Scandola, M. 2011. "Green Composites: An Overview." *Polymer Composites* 32 (12): 1905-1915. doi: 10.1002/pc.21224.
- [3] Taj, Saira, Munawar Ali Munawar, and Shafiullah Khan. 2007. "Natural Fiber-Reinforced Polymer Composites." *Proc. Pakistan Acad. Sci.* 44(2): 129-144.
- [4] Faruk, Omar, Andrzej K. Bledzki, Hans-Peter Fink, and Mohini Sain. "Biocomposites Reinforced with Natural Fibers: 2000–2010." *Progress in Polymer Science* (0). doi: 10.1016/j.progpolymsci.2012.04.003.
- [5] Alamri, H., and I.M. Low. 2012. "Effect of Water Absorption on the Mechanical Properties of n-SiC filled Recycled Cellulose Fiber Reinforced Epoxy Eco-nanocomposites" *Polymer Testing*. 06(001): 810-818.
- [6] Ray, D and J. Rout. 2005. *Thermoset Biocomposites*, eds. A. K. Mohanty, M. Misra and L.T. Drzal, Chapter 9. New York: Taylor & Francis Group. <http://www.crcnetbase.com.dbgw.lis.curtin.edu.au/ISBN/9780203508206> (accessed August 20, 2012).
- [7] Alamri, H., and I.M. Low. 2012b. "Mechanical Properties and Water Absorption Behaviour of Recycled Cellulose Reinforced Epoxy Composites." *Polymer Testing* 31 (5): 620-628. doi: 10.1016/j.polymertesting.2012.04.002.
- [8] Mohan, T.P., and K.Kanny. 2010. "Water Barrier Properties of Nanoclay filled Sisal Reinforced Epoxy Composites." *Composites: Part A*. 12(010): 385-393.
- [9] Alamri, H., I.M. Low. And Z. Allothman 2012. "Mechanical, Thermal and Microstructural Characteristics of Cellulose Fiber Reinforced Epoxy/Organoclay Nanocomposites" *Composites: Part B*. 04(037): 2762-2771.
- [10] Alamri, H., and I. M. Low. 2012a. "Characterization of Epoxy Hybrid Composites Filled with Cellulose Fibers and Nano-Sic." *Journal of Applied Polymer Science* 126 (S1): E221-E231. doi: 10.1002/app.36815.
- [11] Reis, J. M. L. 2006. "Fracture and Flexural Characterization of Natural Fiber-Reinforced Polymer Concrete" *Construction and Building Materials* 20 (9): 673-678. doi: 10.1016/j.conbuildmat.2005.02.008.
- [12] Dhakal, H.N., Z.Y. Zhang and M.O.W. Richardson. "Effect of Water Absorption on the Mechanical Properties of Hemp Fibre Reinforced

- Unsaturated Polyester Composites.” *Composites Science and Technology*. 67(2007): 1674-1683.
- [13] Kim, H.J. and D.W. Seo. 2006. “ Effect of Water Absorption Fatigue on Mechanical Properties of Sisal Textile-Reinforced Composite. “ *International Journal of Fatigue*. 28 (2006): 1307-1314. doi:10.1016/j.ijfatigue.2006.02.018.