

Precision Control of Single-Phase PWM Inverter Using M68HC11E Microcontroller

Khaled A. Madi

Abstract—Induction motors are being used in greater numbers throughout a wide variety of industrial and commercial applications because it provides many benefits and reliable device to convert the electrical energy into mechanical motion. In some application it's desired to control the speed of the induction motor. Because of the physics of the induction motor the preferred method of controlling its speed is to vary the frequency of the AC voltage driving the motor. In recent years, with the microcontroller incorporated into an appliance it becomes possible to use it to generate the variable frequency AC voltage to control the speed of the induction motor.

This study investigates the microcontroller based variable frequency power inverter. the microcontroller is provide the variable frequency pulse width modulation (PWM) signal that control the applied voltage on the gate drive, which is provides the required PWM frequency with less harmonics at the output of the power inverter.

The fully controlled bridge voltage source inverter has been implemented with semiconductors power devices isolated gate bipolar transistor (IGBT), and the PWM technique has been employed in this inverter to supply the motor with AC voltage.

The proposed drive system for three & single phase power inverter is simulated using Matlab/Simulink. The Matlab Simulation Results for the proposed system were achieved with different SPWM. From the result a stable variable frequency inverter over wide range has been obtained and a good agreement has been found between the simulation and hardware of a microcontroller based single phase inverter.

Keywords—Power, inverter, PWM, microcontroller.

I. INTRODUCTION

THE variable frequency inverters are used in wide applications especially three phase induction motor drive traction and it is has a popular in many high power industrial applications, such as speed and torque control. Single phase induction motor (SPIM), which has a common using in residential applications, domestic such as dishwashers, cloth dryers, fans, pumps, etc. ,when the SPIMs are preferred due to the greater availability of single phase power supply. Also this system can be used in other application such as: electric vehicle, variable speed equipment, and AC variable frequency power source used in the laboratory, where there are many experiments require the use of different AC sources in terms of the voltage amplitude and frequency. Thus, it can be very useful in the laboratory for testing appliances, products, and equipment. It may also be helpful in an automated production line for checking the Device Under Test (DUT) in a specified operating range of voltage and frequency [1].

Khaled A. Madi is with Dept. of Electrical and Electronic Engineering Academy Tajoura, Tajoura, Tripoli, Libya (Kaledmadi2002@yahoo.com).

Various researches on the control of the variable frequency inverter have been presented as low-cost, high-performance, and the development was made in several areas, such as: microelectronics, allowing the use of software instead of hardware to solve complex control problems for an affordable price; power semiconductors technology, providing powerful, fast and easy to drive switches; control algorithms, which control the inverter output and reduce the harmonic. As a result of those efforts, AC motor drives are today a very interesting as an alternative to DC motor based systems.

With the increasing demands for high-quality power sources, and reduction of harmonic distortion a PWM inverter has been used as a key element for a high-performance power conversion system for critical loads such as computers, medical equipment and communication systems [2].

Microcontrollers and digital signal processors (DSP) have been available in recent years; applications of advanced control techniques have been reported, many researchers developed the software for the control system, which confirmed the high quality of the control based on microcontroller techniques [3] and to provide additional real time processing throughput in an inverter operation, these features minimize the CPU's overhead in an interrupt intensive application [4].

Motorola MC68HC11 microcontroller has been chosen for this implementation because it is easy to development, instantly response, high performance, high speed and low-power chip with multiplexed capable of running at up to 2 MHZ.

Traditionally, variable speed operation of a single phase induction motor is suffer from large harmonic and limited speed, therefore the system has been built using voltage control method with semiconductors power devices IGBT and to avoid the large harmonics PWM techniques has been implemented.

Simulation of a single phase and three phase variable frequency inverter, which has been constructed on matlab/simulink software to examine its capability to a chive sinusoidal waveform with variable frequency to use as single phase and three phase variable frequency power supply.

The Matlab Simulation Results for the proposed system were achieved with different PWM frequencies this system can be considered as high power variable frequency voltage source inverter, with fewer harmonics. From the result, a stable AC voltage with variable amplitude and variable frequency over wide range has been obtained and a good agreement has been found between the simulation and hardware of a single phase inverter.

II. PAST WORKS

Various convert topologies have been compared by Bathunya et al [5], and he concluded that, among the converter topologies, the adjusted frequency PWM inverter is the best choice for single phase induction motor drives.

Chomat and Lipo [6], considered a system connected to a single-phase supply, the output portion of the converter consisting of two IGBT switches, generates a PWM output supplying one or both stator windings of a single-phase machine. The variable speed operation is characterized by the fact that the both stator windings are fed from the inverter. The phase shift between the currents in the main and auxiliary windings of the machine is maintained by means of an AC capacitor connected in series with the auxiliary winding. The generation of the triggering pulses for the solid-state switches and the state of the output relay are controlled by a single-chip microcontroller.

Jiangmin Yao [7], has implemented the PIC17C756 microcontroller in a single phase induction motor adjustable speed drive control with hardware setup and software program in C code. The main feature used in this microcontroller was its peripherals to realize pulse width modulation in the single phase motor control. Furthermore, one chip and re-programmable ROM replaces the conventional complicated circuit solution. He concluded that this brought low cost, small size and flexibility to change the control algorithm without changes in hardware. The problem for this microcontroller was that it had no dead band register and only had a three PWM output. Therefore, additional logic analogue circuits were added to generate their complement signals and to generate dead time in order to avoid the overlapping of turn on for both upper and lower switches.

Bashi, et al [8], had been developed the single phase induction motor adjustable speed control using MC68HC11E-9 microcontroller. They programmed the microcontroller to vary the pulse width variation that controls the duty cycle of the DC chopper. The inverter receives the DC signal from the chopper and converted to AC power to feed the motor. Their drive system can be used for a chive speed control of a single-phase induction motor with wide speed range, but their system could be technically possible and economical, but the operation of the drive is not optimal throughout the entire speed range and the significant torque ripple may arise in some operating points.

In this work the single phase variable frequency inverter has been implemented. The microcontroller has been programmed to vary the frequency of the output power inverter.

III. MATERIALS AND METHODS

Single phase variable frequency inverter consist of full bridge diode rectifier is fed from 110Vac power supply; the rectifier bridge is used to convert the AC supply voltage to a 155.56Vdc voltage. The output voltage of the rectifier bridge is smoothed using a capacitor which helps to remove its ripples. Then the fixed DC voltage is fed to the single bridge IGBT inverter, which receives the DC voltage and converts it

to AC voltage with variable frequency to feed the motor under control.

The microcontroller has been programmed to vary the frequency of the PWM signal that controls the frequency of the voltage applied at the gate drives, and as a result of this; we can control the frequency of the inverter.

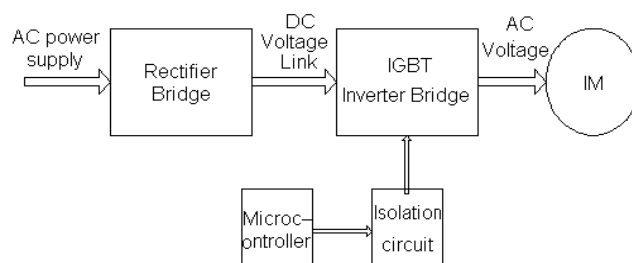

Fig. 1 Block diagram of the system

Three phase variable frequency inverter: The 110Vac 3 phase power supply is converted to into fixed DC voltage by used three phase full bridge diode rectifier. The harmonics are filtered out by an LC filter to provide a smooth DC voltage, which is then applied to the inverter input.

The inverter consists essentially of six power IGBT, this inverter converts the DC link voltage into an adjustable three-phase AC voltage. The PWM control scheme used to control the inverter output voltage and frequency, by modulating the on and off times of power switches.

A. Simulation of the System

Matlab/Simulink software has been used as a tool to simulate the circuit which consists of; full bridge rectifier, and inverter circuit. Fig. 1 shows the complete system single phase inverter, whereas Fig. 2 shows the complete system of three phase inverter.

In the steady state the motor can be simulated as R-L lumped circuit without loss of accuracy. The resistance R reflects the losses in the stator and rotor cores and the inductance for the winding. An experiment is carried out to measure R and L and the measured values were used in the simulation on Matlab/Simulink [3].

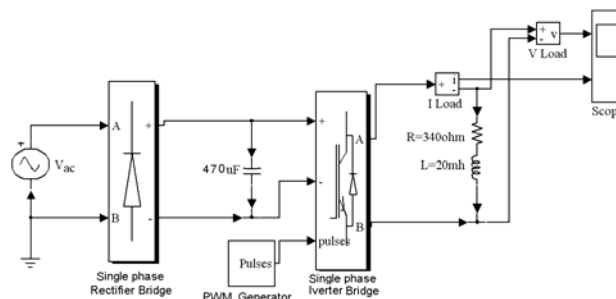

Fig. 2 Block diagram for single phase inverter simulation circuit

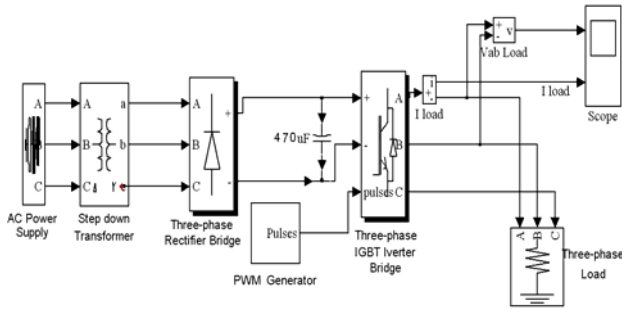

Fig. 3 Block diagram for three phase inverter simulation circuit

B. Experimental Setup

In this study the full bridge rectifier has been used to convert the AC supply to a DC voltage. A capacitor and an inductor are connected to form a smoothing filter. The output of the rectifier is the input to the inverter, which receives the smooth DC voltage and converts it to AC power to get the variable frequency power source.

The microcontroller-based control system hardware has been programmed to vary the frequency of the PWM signal that controls the frequency of the power inverter.

The PWM module gets two inputs “duty cycle and frequency” the frequency is configurable within range 20Hz-2 KHz and the duty cycle can be ranged from 0% to 100%. In order to use the output compare function as PWM generator the frequency is converted from Hz to counts according to the following equation.

$$FREQCNT = \frac{FREQHZ}{0.5 \mu s} \quad (1)$$

where, 0.5µs is the one cycle period of microcontroller.

The PWM signals of the MCU are applied to the gate of IGBT through gate drive; the gate driver provides isolation, low impedance and high current supply to drive the IGBT's. By control the input voltage to the ADC we can control the output frequency of the Microcontroller, since this input analogue voltage is converting to 8 bit digital signals, with resolution 20mV/step.

Under no-load condition the output of the power inverter was smooth, and when this output voltage were fed to the single phase induction motor the motor started run and the response of the drive system was as expected.

C. Simulation & Experimental Result

1) *Simulation Result:* The Matlab Simulation Results for the single phase variable frequency at steady state is shown in Fig. 4, while the experiment result is shown in Fig. 5.

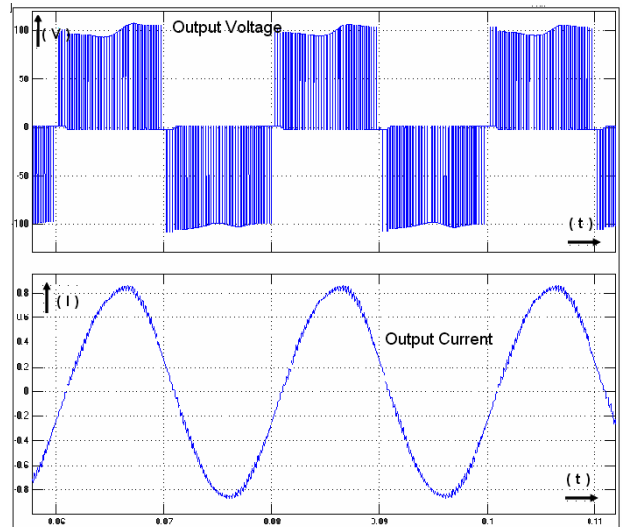

Fig. 4 Load voltage and current for single phase inverter during simulation

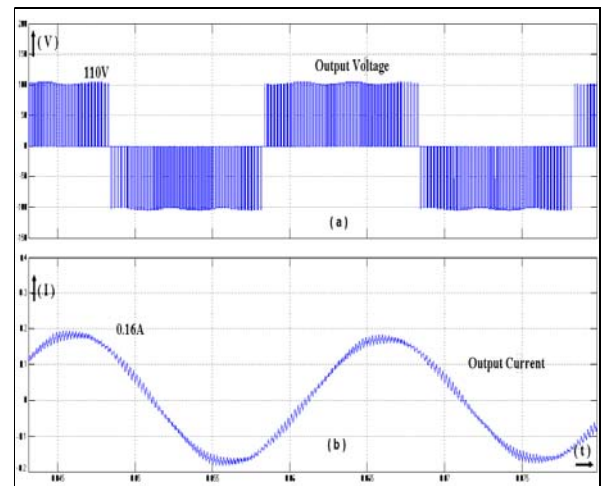

Fig. 5 Load voltage and current for three phase inverter during simulation

2) *Experimental result:* The microcontroller based single phase variable inverter system has been implemented experimentally. Fig. 6 shows the output PWM pulses of the MCU, which are adjustable pulse width and frequency. Whereas, the output voltage and current of the single phase system fed an induction motor are shown in Fig. 7 and 8 respectively.

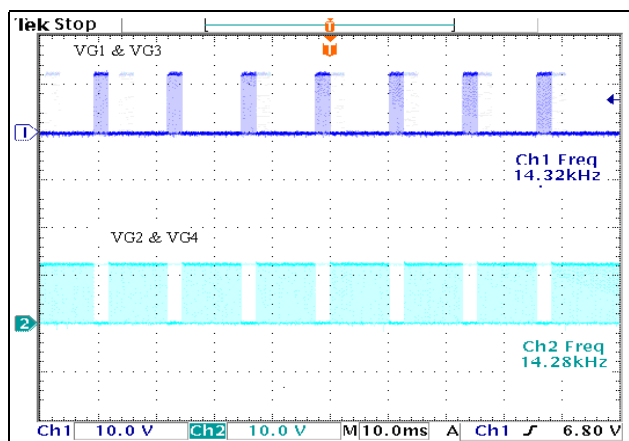

Fig. 6 Firing signal for the single phase inverter

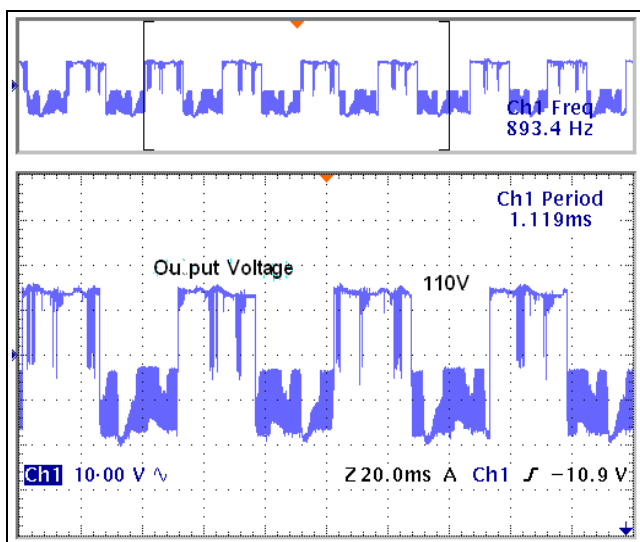

Fig. 7 Load voltage during experiment

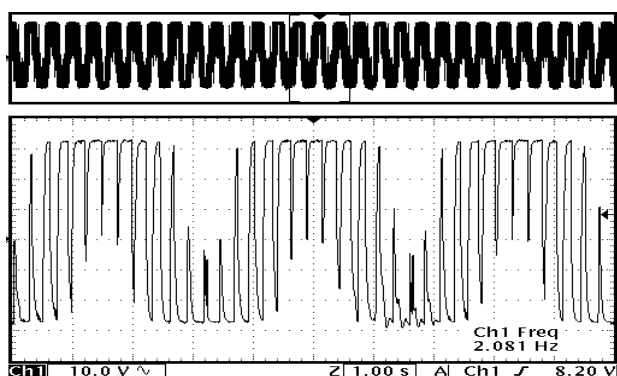

Fig. 8 Load Current during experiment

From comparing the output voltage and current waveforms of the simulation results and experimental results we can observed good agreement has been found between the simulation and experimental results with respect to voltage and current waveform shape.

IV. CONCLUSION

The single phase and three phase variable frequency inverter is simulated using Matlab/Simulink software. The stable AC power source with variable amplitude and variable frequency over wide range has been obtained.

The M68HC11E-9 microcontroller based single phase variable frequency power inverter has been introduced and it can be successfully achieved. The experiment results have been obtained for the microcontroller, which offers reliable and low-cost solutions for single phase variable frequency inverter and good agreement was found between simulation and hardware results.

In general, the AC-DC-AC conversion was successful, on the other side, some overshoot were found due to suspected causes such as the control algorithm used in the microcontroller and harmonic content at the inverter output. However, good results confirming the initial intention for design.

REFERENCES

- [1] K. Low, "A DSP-Based Variable AC Power Source", Instrumentation and Measurement, IEEE Transactions, Vol. 47, NO. 4, 1998, pp: 992-996.
- [2] S. K. Chung, H. B. Shin and H. W. Lee, "Precision Control of Single-Phase PWM Inverter Using PLL Compensation", in Proceedings of the 2005 Electric Power Applications, IEE, Vol. 152, pp. 429 - 436.
- [3] L. Rimifriu, M. Lucanu, C. Aghion, O. Ursaru, "Control With Microcontroller For PWM Single-Phase Inverter," IEEE, "Gh. Asachi" Technical University of Iasi, Faculty of Electronics and Telecommunications, Bd. Carol I, no. 11, Iasi, 700537 Romania. 2003.
- [4] W. Bacharowski, "Microcontrollers in Variable Frequency Inverters", WESCON95, Maintain View, CA. Conference Record, Microelectronics Communications Technology Producing Quality Products Mobile and Portable Power Emerging Technologies, 1995, pp. 13-15.
- [5] A. S. Ba-thunya, R.Khopkar, K. Wei and H. A. Toliyat, "Single Phase Induction Motor Drives-A Literature Survey," Electric Machines and Drives Conference. IEMDC 2001, College Statias, Texas, IEEE International 2001, pp. 911 – 916.
- [6] M. Chomat and T. A. Lipo, "Adjustable-Speed Single-Phase IM Drive with Reduced Number of Switches," Industry Applications Conference, Conference Record of the IEEE, Chicago, USA, 2003, Vol. 39, pp. 819 - 825.
- [7] J. Yao, "Single Phase Induction Motor Adjustable Speed Control Using DSP and Microcontroller," Course Project for ECE734 Fall Semester at UW-Madison, 2000, pp. 1-7.
- [8] S. M. Bashi, I. Aris and S.H. Hamad "Development of Single Phase Induction Motor Adjustable Speed Control Using M68HC11E-9 Microcontroller," Journal of Applied Sciences 5 (2), pp. 249-252.