

Burning Rates of Turbulent Gaseous and Aerosol Flames

Shaharin A. Sulaiman, Malcolm Lawes

Abstract— Combustion of sprays is of technological importance, but its flame behavior is not fully understood. Furthermore, the multiplicity of dependent variables such as pressure, temperature, equivalence ratio, and droplet sizes complicates the study of spray combustion. Fundamental study on the influence of the presence of liquid droplets has revealed that laminar flames within aerosol mixtures more readily become unstable than for gaseous ones and this increases the practical burning rate. However, fundamental studies on turbulent flames of aerosol mixtures are limited particularly those under near mono-dispersed droplet conditions. In the present work, centrally ignited expanding flames at near atmospheric pressures are employed to quantify the burning rates in gaseous and aerosol flames. Iso-octane-air aerosols are generated by expansion of the gaseous pre-mixture to produce a homogeneously distributed suspension of fuel droplets. The effects of the presence of droplets and turbulence velocity in relation to the burning rates of the flame are also investigated.

Keywords—Burning Rate, Droplets, Flames, Turbulent

I. INTRODUCTION

COMBUSTION of fuel sprays is a very important area in gas turbines, diesel and spark ignition engines, furnaces and hazardous environments. However, the exploration of important parameters in practical combustion systems is difficult due to the multiplicity of dependent variables such as spatial variations in pressure, temperature, equivalence ratio, and droplet sizes. Thus, fundamental study on the influence of the presence of liquid droplets in aerosol flames is vital before the behaviour of practical spray combustion can be fully understood. Information on laminar burning velocity of aerosol flames is sparse, even for gaseous mixtures at conditions pertaining to engines, which range from sub-atmospheric to high pressure and temperature.

Theoretical [1, 2] and experimental [3-5] studies suggested that laminar flame propagation through aerosol/vapour clouds, under certain circumstances, is higher than that in a fully vaporised homogeneous mixture. However, there is little experimental data of a fundamental nature that demonstrates the similarities and differences in burning rate of turbulent flames between single and two-phase combustion. Myers and

Lefebvre [3] investigated the influence of mean droplet size and mainstream velocity on flame speed using mixtures of JP 7 fuel drops and air in a circular duct. They suggested that the enhanced flame speed with an increase in the mainstream velocity was a result of increase in the associated turbulence intensity. In various researches, it was reported that the turbulent flame speed was inversely proportional with the mean droplet size [3, 4, 6-8]. The droplet evaporation rates were suggested to control the turbulent flame speed [3, 7]. However, El-Banhawy and Whitelaw [7] also suggested that droplet evaporation would only have an influence on the combustion process if a time characteristic of the turbulent mixing between fuel and air were comparable to that which characterizes droplets evaporation.

In a more recent work, Marquez [9] showed that the burning velocity of turbulent iso-octane-air aerosol mixtures could be potentially lower than that of gaseous flames. However, the difference in the conditions of aerosols and gaseous mixtures in Marquez's comparison were large, and thus could be misleading. For example, the initial temperatures between the aerosol and gaseous mixtures were different by 96 K, which was significantly large. Furthermore, it was shown by Bradley *et al.* [10] through experiments with laminar gaseous flames that such a large increase in initial temperature would result in an increase in the laminar burning velocity by approximately 30%.

In the present work, spherically expanding flames following central ignition of globally homogeneous combustible fuel mixtures at near atmospheric pressures were employed to quantify the structure of instabilities in turbulent aerosol flames. Iso-octane-air aerosols were generated by expansion of the gaseous pre-mixture to produce a homogeneously distributed suspension of fuel droplets. The effect of droplets on turbulence flames was examined at various values of r.m.s. turbulent velocity fluctuation, u' . Comparisons were made between turbulent flames of gaseous and aerosols at as near as possible, similar conditions.

II. EXPERIMENTAL SETUP

A. Apparatus

Shown in Figure 1 is a schematic of the combustion apparatus. Full descriptions of the system and aerosol generation technique are presented in [11]. The explosion vessel, which essentially resembled a Wilson cloud chamber [12], was a cylindrical vessel of 305 mm diameter by 305 mm

S. A. Sulaiman is with the Department of Mechanical Engineering, Universiti Teknologi PETRONAS, 31750 Tronoh, Perak, Malaysia (phone: 605-368-7013; fax: 605-365-6461; e-mail: shaharin@petronas.com.my).

M. Lawes is with the School of Mechanical Engineering, University of Leeds, UK.

long. Optical access windows of 150 mm diameter were provided on both end plates for characterization of aerosol and photography of flame propagation. Two electrical heaters were attached to the wall of the vessel to preheat the vessel and mixture to 303 K.

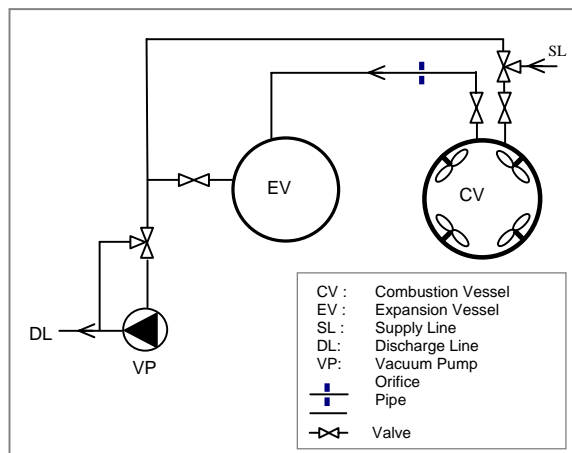

Fig. 1 Apparatus for aerosol generation

Four identical eight-bladed fans were fitted, equi-spaced around the central circumferential plane at 45° to the horizontal. These were connected to 3-phase 1.5 kW motors and electronic motor controllers. The fans provided the required flow field and they generated isotropic turbulence within the field of view of the windows. The vessel turbulence was characterised by Lawes [13] and the r.m.s. turbulent velocity fluctuation was found to be a linear function of fan speed by

$$u' = 0.0016 \omega \quad (1)$$

where ω is the fan speed in rpm.

B. Aerosol Generation and Characterization

Iso-octane-air aerosol mixtures were prepared by a condensation technique [11], used elsewhere in combustion studies in [14-16], to generate well defined, near mono-dispersed, droplet suspensions in-situ by controlled expansion of a gaseous fuel-air mixture from the explosion vessel into the expansion tank, which was pre-evacuated to less than 0.001 MPa. This caused a reduction in mixture pressure and temperature, which took it into the condensation regime and caused droplets to be formed.

The characteristics of the generated aerosol were calibrated by in-situ measurements of the temporal distributions of pressure, temperature, and droplet size and number, without combustion, with reference to the time from start of expansion. Shown in Figure 2 is a typical variation of temperature and pressure during the expansion of a turbulent stoichiometric mixture of iso-octane-air at initial conditions of $P = 200$ kPa, $T = 303$ K and $u' = 1.0$ m/s. The fluctuations in

the measurements were the effect of electronic signal noise caused by the fan motors. The expansion process took place in less than one second. The temperature of the mixture dropped to a value of lower than -10°C .

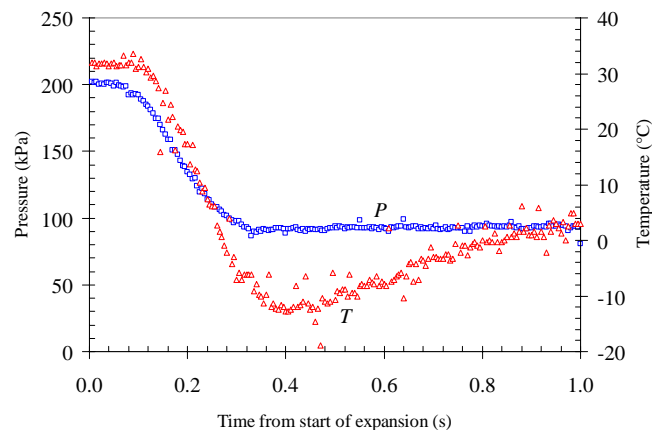

Fig. 2 Typical variation of temperature and pressure during the expansion of a turbulent mixture of iso-octane-air

The droplet arithmetic mean diameter, D_{10} , was measured using a Phase Doppler Anemometer (PDA) system. The number density of droplets, N_D , was estimated from laser extinction measurement during expansion by using the Beer-Lambert Law correlation given in [17]. Because expansion took place over a period of several seconds while combustion took place over less than 30 ms, the far field values of D_{10} were assumed to be constant during combustion. Detailed descriptions of the techniques for characterization of the mixture droplets were published elsewhere [11].

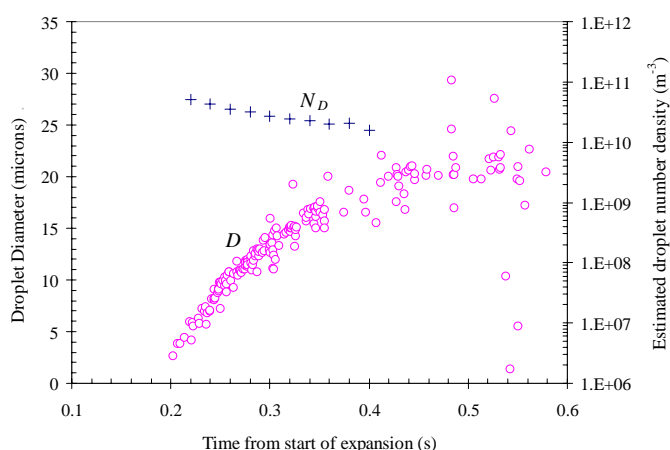

Fig. 3 Variation of droplet size, D , and droplet number density, N_D , during the expansion of a turbulent mixture of iso-octane-air

Shown in Fig. 3 is the variation of droplet size and number density of droplets with time from the start of expansion from

the same experiment as in Figure 2. Droplet nucleation started approximately 0.2 s after the expansion, as evident by the increase in D . It is shown that N_D is consistently in the order of 10^{10} m^{-3} , immediately after the start of condensation. Clearly, the distribution of droplet size that results in the present apparatus is shown in Figure 3 to be near mono-dispersed at between about 0.2 and 0.4 s after the onset of droplet nucleation. This is also supported by the typical histogram in Figure 4, which shows a narrow droplet distribution at 0.25 seconds after the start of expansion. The spatial distribution of droplet size was also monitored and was found to be reasonably uniform [9].

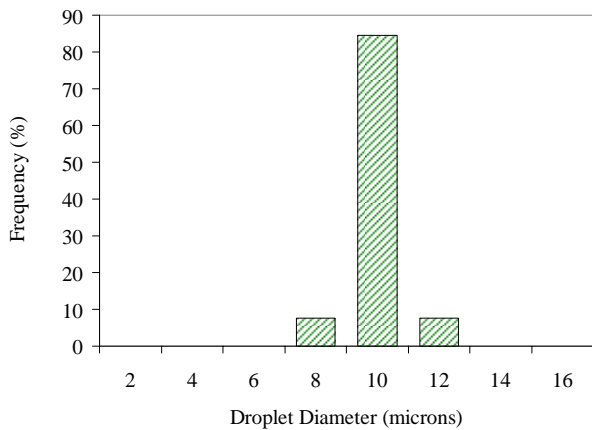

Fig. 4 Typical histogram for droplet diameter distributions for turbulent iso-octane-air aerosol mixture in Figure 3 at time of 0.25 ± 0.005 s after start of expansion.

C. Recording of Flame Images

The aerosol mixture was ignited at the centre of the explosion vessel by an electric spark of about 500 mJ. The flame front was monitored through the vessel's windows by schlieren movies, which were recorded using a high speed digital camera at a rate of 1000 frames per second and with a resolution of $256 \text{ pixels} \times 256 \text{ pixels}$. The flame image was processed digitally to obtain the radius of the flame front, r , by using image-processing software described in [18].

The flames speed, S_f , is obtained from the measured flame front radius against time by

$$S_f = \frac{dr}{dt} \quad (2)$$

III. RESULTS AND DISCUSSIONS

The effect of droplets on turbulence aerosol flames was examined by comparing the burning rates with those of turbulent gaseous flames. Comparison was also done for experiments at various values of u' .

A. Observation of Flames

Shown in Figure 5 are typical schlieren images of turbulent flames for stoichiometric iso-octane-air aerosol mixtures at $P = 128 \text{ kPa}$, $T = 283 \text{ K}$, $D_{10} = 4 \text{ }\mu\text{m}$ and u' of (a) 1.0 m/s and (b) 2.5 m/s. The circular boundary represents the 150-mm diameter field of view of the camera as determined by the optical access windows and schlieren setting. The black horizontal object in each of the photographs is the spark electrode holder. In general, it is shown in Figure 5 that turbulent flames wrinkle and deform considerably as compared to the nearly spherical laminar flames of aerosol mixtures [19]. The degree of wrinkling is also shown qualitatively to increase with u' . The schlieren images of turbulent gaseous flames (not shown) at similar conditions using the same experiment rig were found to be similar to those for the aerosol mixtures. For aerosol with larger droplets ($D_{10} > 4 \text{ }\mu\text{m}$) the mixtures failed to ignite, probably due to the need for higher ignition energy.

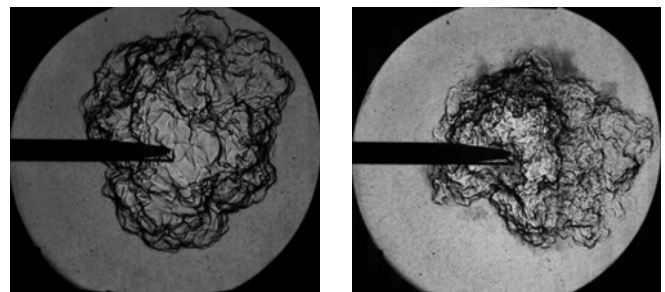

(a) $u' = 1.0 \text{ m/s}$

(b) $u' = 2.5 \text{ m/s}$

Fig. 5 Typical schlieren images of turbulent flames in stoichiometric iso-octane-air aerosols using the same spark electrode and energy.

B. Effect of Presence of Droplets

Shown in Figure 6 is the variation of radius with time for stoichiometric iso-octane-air mixtures at u' of 1.0 m/s. The triangular markers represent the results for gaseous mixtures at $P = 100 \text{ kPa}$ and $T = 303 \text{ K}$; the circles represent those for aerosol mixtures at $P = 128 \text{ kPa}$, $T = 283 \text{ K}$ and $D_{10} = 4 \text{ }\mu\text{m}$. The slight difference in pressure and temperature for the different flames was unavoidable and was due to the method of thermodynamic aerosol generation; this was described in [20]. The gaseous (single phase) flames could not be studied within the range of pressures and temperatures of aerosols because at such conditions the mixture would be in the wet, or two-phase, regime. However, Bradley *et al.* [10] have shown that, for gaseous flames, such small differences in pressure and temperature have little effect on the burning rate. For each condition, up to five explosions are plotted. The fluctuation in within the results is shown to be low for small flame kernels ($r < 10 \text{ mm}$) but gradually increases with time, possibly due to the effect of large turbulent eddies. It is shown in Figure 6 that the radii for both aerosol and gaseous flames are nearly identical during the first 5 ms of the flame development. Thereafter, the radius of the turbulent gaseous flames is shown

to be always higher than that of aerosol flames.

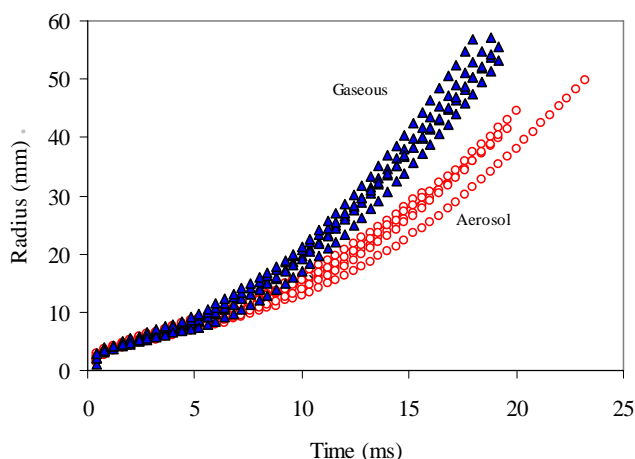

Fig. 6 Variations of flame radius with time for turbulent mixtures of stoichiometric iso-octane-air at u' of 1.0 m/s.

Shown in Figure 7 is the resulting turbulent flame speed, plotted against time after ignition, for the mixtures in Figure 6. The turbulent flame speed was obtained using Eq. (2). In Figure 7, the variation of turbulent flame speed is plotted against the flame radius. The fluctuation in the results is within a maximum value of less than 1.0 m/s. The turbulent flame speed of the gaseous mixtures is shown in Figures 7 and 8 as identical with that of the aerosol mixture during the first 5 ms of the flame development. This is most probably due to the fact that the energy for the flame kernel is contributed mainly by the spark ignition. A regime of flame development as reported in [21] for laminar flames is also exhibited in Figures 7 and 8 during the start of ignition. The flame speed was relatively high as a result of active radicals provided by the spark energy. However, high stretch rates of the flames caused the flame speed to decrease rapidly when the thermal energy of the spark was dissipated into the reactant and before normal flame chemistry developed.

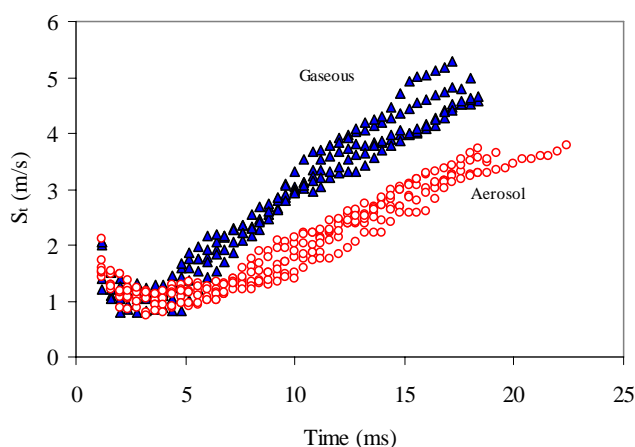

Fig. 7 Variations of turbulent flame speed with time for the

mixtures in Fig. 6.

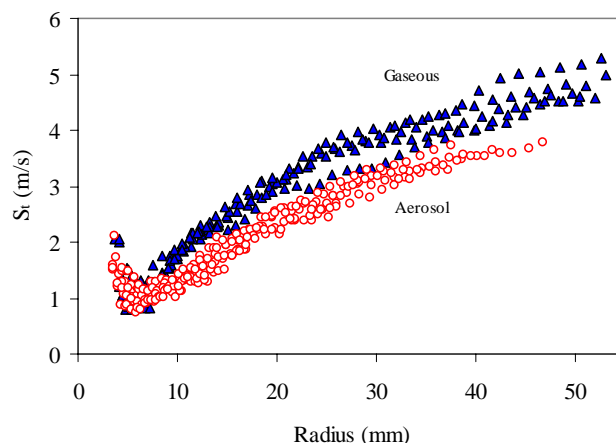

Fig. 8 Variations of turbulent flame speed with radius for the mixtures in Fig. 6.

The general trend in Figures 7 and 8 is a sustained increase in S_t with time and radius with no evidence of flame speed stabilization as was observed for the laminar cases [19]. Obviously the gaseous flames in Figure 7 exhibited a higher acceleration rate at between 5 and 10 ms after the start of ignition, resulting in a distinct separation between the plots for gaseous and aerosol flames. During this period, the effect from the spark had decayed and therefore further flame propagation depended on the readiness of the fuel-air mixtures to burn. Droplets in the aerosol mixtures require more time to sustain the chemical reaction as they need to evaporate first, as compared to the gaseous mixtures, and this explains the reason for faster burning rate of gaseous flames. Interestingly after 10 ms, the gradients of the graphs are quite parallel. This implies a possibility that the rate of acceleration for turbulent flame of gaseous and aerosol mixtures are similar after 10 ms; the same trend is also exhibited in Figure 8. Although the aerosol flames are shown to always have lower flame speeds, this is mainly the result of slow reactions at the initial stage of the flame development (<10 ms). If this effect of slow initial reaction in aerosol flames were absent, it is probable that the plot for the turbulent flames of gaseous and aerosol mixtures would be identical.

In the present work, the effect of droplet size, which was observed a contributor to instabilities in laminar flames [11], could not be shown. Although, as indicated in Figure 3, near mono-dispersed droplets could be generated up to about 20 μm , the experiments were limited to small droplets (4 μm). This was because the energy required to ignite aerosols of large droplet would be higher, as reported in [20].

C. Effect of R.M.S. Turbulence Velocity Fluctuation

To demonstrate the effect of r.m.s. turbulent velocity fluctuation, u' , the explosion experiments were repeated at same conditions of turbulent iso-octane aerosol mixtures (stoichiometric, $P = 128$ kPa, $T = 283$ K, $D_{10} = 4$ μm) but at

different values of u' . The results are shown in Figures 9 and 10, in terms of S_t versus time and radius, respectively, for u' of 1.0 m/s (circles), 1.5 m/s (crosses) and 2.5 m/s (squares). For each condition, a minimum of three explosions is plotted.

The trends for the turbulent aerosol flames in Figures 9 and 10 are similar to those for the flames in Figures 7 and 8, in which S_t increases with time and radius. The spark-affected flame behavior during the first 5 ms, as in Figures 7 and 8, is also shown in Figure 9 and 10. The flame growth rates for the aerosol mixtures are shown to increase with u' ; and the trend is similar to that for turbulent gaseous flames as reported by Ormsby [22]. In addition Figures 9 and 10 show that a larger scatter of results are found for turbulent aerosol flames at the higher turbulence as compared to the lower one, which is most probably the effect of turbulence velocity fluctuation.

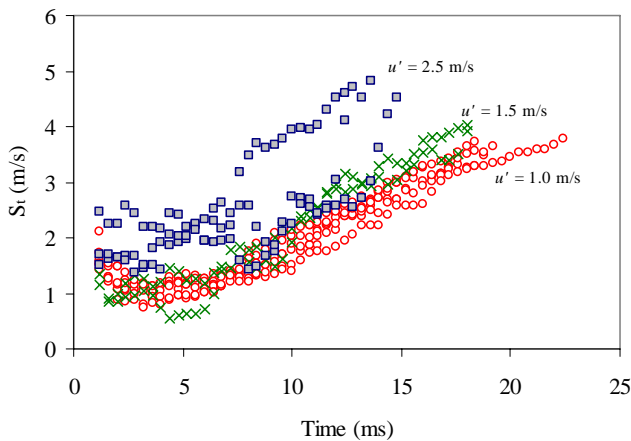

Fig. 9 Variation of S_t with time for turbulent flames of stoichiometric iso-octane aerosol ignited at $D_{10} = 4 \mu\text{m}$, and u' of 1.0, 1.5 and 2.5 m/s.

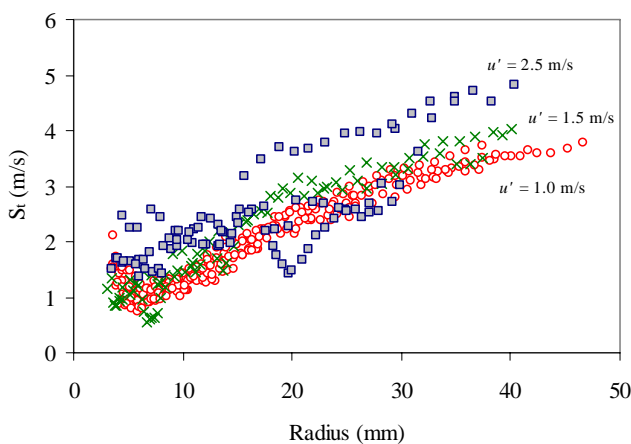

Fig. 10 Variation of S_t with radius for the turbulent flames in Fig. 9.

It is shown in Figures 9 and 10 that during the initial kernel growth period, some of the flames had near zero values of S_t . These very slow initial propagation rates were probably due to the phenomenon described by Maly [23] as the random transport

of the ignition kernel, due to flow field, towards the electrode, which consequently increased the heat loss from the flame kernel to the spark plug.

IV. CONCLUSION

The effects of droplets and r.m.s. turbulent velocity fluctuation, u' , have been experimentally studied in centrally ignited spherical turbulent aerosol flames. Comparison of results was made with those for turbulent gaseous flames. Inspection of schlieren cine photographs revealed that turbulent aerosol flames wrinkled and deformed significantly as compared to laminar aerosol flames. The effect was shown more obviously with an increase in u' .

The flame propagation rate of turbulent aerosol flames was shown to be slower than that of turbulent gaseous flames. This was probably caused by the longer time taken by aerosol flames during ignition due to the need to evaporate the droplets. However, after the flames had become fully developed, the rate of flame acceleration for the turbulent aerosol flames was shown to be similar with that of turbulent gaseous flames. As in gaseous flames, an increase in the r.m.s. turbulent velocity fluctuation increased the turbulent flame speed of the aerosol flames. A study on the effect of droplet size by using larger spark energy is recommended in the future.

ACKNOWLEDGMENT

The authors would like to acknowledge Universiti Teknologi PETRONAS, Malaysia, for its support in this work.

REFERENCES

- [1] J. B. Greenberg, "Propagation and Extinction of an Unsteady Spherical Spray Flame Front," *Combust. Theory Modelling*, vol. 7, pp. 163-174, 2003.
- [2] T. H. Lin and Y. Y. Sheu, "Theory of Laminar Flame Propagation in Near-Stoichiometric Dilute Sprays, *Combustion and Flame*," *Combustion and Flame*, pp. 333, 1991.
- [3] G. D. Myers and A. H. Lefebvre, "Propagation in Heterogeneous Mixtures of Fuel Drops and Air," *Combustion and Flame*, vol. 66, pp. 193-210, 1986.
- [4] G. A. Richards and A. H. Lefebvre, "Turbulent Flame Speeds of Hydrocarbon Fuel Droplets in Air," *Combustion and Flame*, vol. 78, pp. 299-307, 1989.
- [5] D. R. Ballal and A. H. Lefebvre, "Flame Propagation in Heterogeneous Mixtures of Fuel Droplets, Fuel Vapor and Air," *Proc. Combust. Inst.*, 1981.
- [6] Y. Mizutani and A. Nakajima, "Combustion of Fuel Vapour-Drop-Air Systems: Part II, Spherical Flames in a Vessel," *Combustion and Flame*, vol. 21, pp. 351-357, 1973.
- [7] Y. El-Banhawy and J. H. Whitelaw, "Experimental Study of the Interaction Between a Fuel Spray and Surrounding Combustion Air," *Combustion and Flame*, vol. 42, pp. 253-275, 1981.
- [8] S. H. Stårner, J. Gounder, and A. R. Masri, "Effects of Turbulence and Carrier Fluid on Simple, Turbulent Spray Jet Flames," *Combustion and Flame*, vol. 143, pp. 420-432, 2005.
- [9] N. Marquez, *Fundamental Studies of Aerosol Flames*, PhD Thesis, School of Mechanical Engineering, University of Leeds, UK, 2003.
- [10] D. Bradley, R. A. Hicks, M. Lawes, C. G. W. Sheppard, and R. Woolley, "The Measurement of Laminar Burning Velocities and Markstein Numbers of Iso-Octane-Air and Iso-Octane-n-Heptane-Air Mixtures at Elevated Temperatures and Pressures in an Explosion Bomb," *Combustion and Flame*, vol. 115, pp. 126-144, 1998.

- [11] M. Lawes, Y. Lee, and N. Marquez, "Comparison of Iso-octane Burning Rates between Single-phase and Two-phase Combustion for Small Droplets," *Combustion and Flame*, vol. 144, pp. 513-525, 2006.
- [12] C. T. R. Wilson, "Condensation of Water Vapour in the Presence of Dust-Free Air and Other Gases," *Proc. of the Royal Society of London*, 1897.
- [13] M. Lawes, Effects of Turbulence on Combustion in Engines, PhD Thesis, School of Mechanical Engineering, University of Leeds, 1987.
- [14] K. Nakabe, Y. Mizutani, F. Akamatsu, M. Fuchihata, and S. H. ElEmam, "Spark-Ignited Spherical Flames Propagating in a Suspended Droplet Cloud," *5th International Conference on Liquid Atomization and Spray Systems (ICLASS-91)*, 1991.
- [15] S. Hayashi and S. Kumagai, "Flame Propagation in Fuel Droplet-Vapor-Air Mixtures," *Proc. Combustion Institute*, 1974.
- [16] S. Hayashi, S. Kumagai, and T. Sakai, "Propagation Velocity and Structure of Flames in Droplet-Vapor-Air Mixtures," *Combustion Science & Technology*, vol. 15, pp. 169-177, 1976.
- [17] W. D. Bachalo, A. B. Rosa, and S. V. Sankar, Diagnostic for Fuel Spray Characterization, in *Combustion Measurements*, N. Chigier, Ed., New York, Hemisphere, 1991.
- [18] S. A. Sulaiman, M. Lawes, S. Hassan, and Z. A. Abdulkarim, "High-Speed Schlieren Imaging of Spherically Propagating Laminar Flames of Iso-Octane-Air Aerosol Mixtures," *3rd World Engineering Congress*, Penang, 2007.
- [19] S. A. Sulaiman and M. Lawes, "High-Speed Schlieren Imaging and Post-Processing for Investigation of Flame Propagation within Droplet-Vapour-Air Fuel Mixtures," *IEM Journal*, vol. 69, pp. 53-60, 2008.
- [20] S. A. Sulaiman, Burning Rates and Instabilities in the Combustion of Droplet and Vapour Mixtures, PhD Thesis, Department of Mechanical Engineering, University of Leeds, UK, 2006.
- [21] Y. Ali, D. Bradley, M. Lawes, and E. M. J. Mushi, "Problems of the Measurement of Markstein Lengths with Explosion Flames," *The Combustion Institute, Proceedings of the British and German Sections*, Queen's College Cambridge, 1993.
- [22] M. P. Ormsby, Turbulent Flame Development in a High-Pressure Combustion Vessel, School of Mechanical Engineering, University of Leeds, 2005.
- [23] R. Maly, Spark Ignition: Its Physics and Effect on the Internal Combustion Engine, in *Fuel economy in Road Vehicles Powered by Spark Ignition Engines*, J. C. Hilliard and G. S. Springer, Eds, New York, Plenum Press, 1984.