

# Analysis of a WDM System for Tanzania

Shaban Pazi, Chris Chatwin, Rupert Young, and Philip Birch

**Abstract**—Internet infrastructures in most places of the world have been supported by the advancement of optical fiber technology, most notably wavelength division multiplexing (WDM) system. Optical technology by means of WDM system has revolutionized long distance data transport and has resulted in high data capacity, cost reductions, extremely low bit error rate, and operational simplification of the overall Internet infrastructure. This paper analyses and compares the system impairments, which occur at data transmission rates of 2.5Gb/s and 10 Gb/s per wavelength channel in our proposed optical WDM system for Internet infrastructure in Tanzania. The results show that the data transmission rate of 2.5 Gb/s has minimum system impairments compared with a rate of 10 Gb/s per wavelength channel, and achieves a sufficient system performance to provide a good Internet access service.

**Keywords**—Internet infrastructure, WDM system, standard single mode fibers, system impairments.

## I. INTRODUCTION

EARLY optical networking systems used a single wavelength of light on one optical fiber. However, the bandwidth capacity of optical fiber cable is much greater than the amount of data that can be encoded onto a single wavelength. In order to take advantage of this extra capacity and maximize the use of early optical systems, the technology of wavelength division multiplexing (WDM) has been developed and is being used around the world to improve the existing Internet infrastructures.

A WDM is basically a fiber optical transmission technique, which multiplexes many signals of different wavelength and is capable of providing data capacity in excess of hundreds of gigabit per second over thousands of kilometers in a single mode fiber. At the present, most countries in the world have implemented Internet infrastructure by means of WDM systems to provide high bandwidth and a high-speed Internet service.

S.M. Pazi is with Industrial Informatics and Manufacturing Systems, Department of Engineering and Design, University of Sussex, Falmer, Brighton BN1 9QT, UK. Phone: +44-1273-872642, Fax: +44-1273-678399 (Email: s.m.pazi@sussex.ac.uk). Correspondences Author.

C.R. Chatwin is with Industrial Informatics and Manufacturing Systems, Department of Engineering and Design, University of Sussex, Falmer, Brighton BN1 9QT, UK. (Email: c.r.chatwin@sussex.ac.uk)

R.C.D Young is with Industrial Informatics and Manufacturing Systems, Department of Engineering and Design, University of Sussex, Falmer, Brighton BN1 9QT, UK. (Email: r.c.d.young@sussex.ac.uk).

P. Birch is with Industrial Informatics and Manufacturing Systems, Department of Engineering and Design, University of Sussex, Falmer, Brighton BN1 9QT, UK. (Email: p.m.birch@sussex.ac.uk).

A WDM system is needed to support Internet infrastructure, which currently transmits more than data rate of 40 Gb/s per wavelength channel on a single mode fiber over a long distance. No other Internet infrastructure systems apart from WDM system can support these scalable high speeds and huge bandwidth over a longer distance. The WDM system use optical fibers for data transmission, which is more secure compared with other data transmission systems, e.g., satellite, from tapping (as light does not radiate from the fiber, it is nearly impossible to tap into it secretly without detection) and is also immune to interference and crosstalk.

The possibility of using existing optical fibers from the early optical systems more efficiently makes the WDM system a very attractive commercial proposition, thus it can be considered to be the right choice for constructing an Internet infrastructure everywhere in the world.

As it is expensive to install new fibers in the ground, the proposed WDM system for Tanzania will use the standard single mode fibers [1] from the existing optical systems, which are owned by private and government companies. Although the standard single mode fiber is seen as a perfect data transmission medium with almost limitless bandwidth and distances, it can be the most limiting component of the WDM system. This is because the standard single mode fiber is dominated by system impairments, which occurs on data transmission in the wavelength region of the 1550 nm in the WDM system.

The rest of the paper is organized as follows. In section II, we describe a WDM system for Tanzania. In section III, we analyze and provide techniques to reduce system impairments. Section IV discusses system performance. Section V provides simulation results. Finally, we summarize the paper in section VI.

## II. WDM SYSTEM IN TANZANIA

The WDM system for Internet infrastructure in Tanzania has been proposed by using 4-interconnected WDM ring networks as shown in the block diagram in Fig. 1, this will reduce the Internet connection charge and provide Internet access to the majority of the people who live in both urban and rural areas. The distance between 2-nodes in a ring and a total length of one WDM ring is estimated to be not more than 600 km and 3000 km respectively. The WDM network nodes represent 20 cities in Tanzania, and each one is installed with reconfigurable add/drop multiplexers (ROADM) or an optical crossconnect switch (OXC) as shown in the block diagram.

The optical WDM network is then connected to the rest of

the world via the East African submarine cable [2] through Dar-es-Salaam (DSM) and Coast cities. Note: The ROADM and OXC are outlined with a circle and box respectively as shown in the block diagram. Apart from OXC and ROADM, the following components are also installed in the WDM system [3], [4]: transmitter, receiver, optical fiber (Standard single mode fibers), optical amplifier, multiplexers/demultiplexers (MUX/DEMUX), and regenerators. These components allow a WDM system to transmit data to any other network, e.g. IP, SONET or ATM networks.

Data are converted into electrical signals and coded to the non-return-to-zero (NRZ) modulation format, then converted into light signals, and assigned a wavelength channel for transmission by means of a transmitter. The transmitter consists of tunable laser along with an external modulator. The signals from the different wavelengths channels are combined into a standard single mode fiber by an optical multiplexer and amplified using erbium-doped fiber amplifiers (EDFAs), which are spaced 120 km along the link.

A post amplifier is used to increase the output power; a line amplifier is used typically in the middle of the link to compensate for link loss, which is normally about 0.2 dB/km on a single mode fiber. A preamplifier amplifier is used just in front of a receiver to improve the bit error ratio (BER). The EDFAs operate in the C-band and operate over the range of 1530 nm to 1560 nm, about 30 nm line width. This spectral range supports 40 WDM signal channels with a separation of 0.8 nm (corresponding to 100 GHz, ITU standard).

The optical demultiplexer separates out the WDM signal channels with minimum system impairments and directs them to the individual channel receiver, which converts an optical signal into an electrical signal. The receiver comprises of a photodetector to generate an electrical current, it has a front-end amplifier to increase the power of the generated electrical signal, a filter to minimize noise of the amplified electrical current, and a decision circuit to determine whether the transmitted bit was 1 or 0 in each bit interval.

A ROADM allows single or multiple wavelengths dependent upon Internet traffic to be dropped and added to a multi-wavelength fiber. A ROADM has two line ports and a number of local ports where individual wavelength channels are dropped and added. An OXC essentially performs a similar function to a ROADM but at much larger sizes. OXC have a larger number of ports and are able to switch wavelengths from one input port to another.

### III. SYSTEM IMPAIRMENTS ANALYSIS

#### A. Attenuation

Attenuation in optical fibers leads to a loss of signal power as the signal propagates over a prescribed distance [5]. Since most of the optical fibers deployed in Tanzania are standard single mode fibers. These optical fibers have attenuation loss of 0.2 dB/km in the 1.55-micron band in which a WDM system operates. The optical amplifier (EDFAs) as described

above are spaced 120 km along the WDM span to boost the power of the WDM signal so as to compensate for fiber attenuation, but this compensation results in noise in the WDM system as described below.

#### B. Signal-spontaneous noise

Optical amplification is not possible without the generation of amplified spontaneous emission (ASE), and the noise resulting from this ASE constitutes perhaps the most severe impairments that limit the reach and capacity of the WDM system [6]. Each EDFA contributes ASE, which can be expressed as:

$$P_{ASE} = 2hv \cdot \Delta v \cdot n_{sp} (G-1) \quad (1)$$

Where  $P_{ASE}$  is the ASE power (noise) in an optical bandwidth  $\Delta v$ ,  $h$  is Planck's constant,  $v$  is the optical frequency,  $n_{sp}$  is the spontaneous emission factor, and  $G$  is the optical amplifier gain. These contributions add cumulatively along the amplifier chain, and gives rise to signal spontaneous beat noise at the receiver, which is the fundamental noise limit in an optically amplified transmission system.

The signal-spontaneous noise impairment can be characterized in terms of the optical signal to noise ratio (OSNR) as shown in equation (2), and is defined as the ratio of the signal channel power to the power of the ASE in a specified optical bandwidth.

$$OSNR = \frac{P_{out}}{2hv \cdot \Delta v \cdot n_{sp} (G-1)} \quad (2)$$

#### C. Chromatic Dispersion

This type of dispersion occurs in single mode fibers, and is the widening of pulse duration as it travels through an optical fiber. As a pulse widens, it can broaden enough to interfere with neighboring pulses on the fiber, leading to a bit error at the receiver [5], [6]. The approximate dispersion limit for a non-return-to-zero (NRZ) data signal by using an external modulator along a distributed feedback (DFB) laser is given in [6] by the equation (3)

$$D(\text{ps/nm}) = \frac{104000}{B^2} \quad (3)$$

Where  $D$  is chromatic dispersion in ps/nm and  $B$  is a bit rate in Gb/s. Since the standard single mode fiber has a total dispersion of 17 ps/nm-km in the lower loss wavelength region of 1550 nm. Therefore the data transmission of 2.5 Gb/s and 10 Gb/s will be limited up to approximately distances of 980 km and 60 km respectively as per above equation.

In order to compensate for chromatic dispersion in a WDM system that uses standard single mode fibers, chromatic dispersion compensating fibers (DCFs) are used. Dispersion compensation fibers are normally employed when external modulation is not sufficient, especial for transmission of 10 Gb/s or more data rate per wavelength channel. DCF provides negative chromatic dispersion in the 1550 nm wavelength

region. Example: a 120 km distance of standard single mode fiber has an accumulated or total chromatic dispersion of 17 ps/nm x 120 km = 2040 ps/nm-km.

Thus a DCF with a chromatic dispersion of -2040 ps/nm-km can be used to compensate for this accumulated chromatic dispersion to yield a net zero chromatic dispersion. The DCF are normally installed in each amplifier site, so as to compensate a chromatic dispersion. Since the chromatic dispersion varies for each channel, it is not possible to compensate for the entire system using a common chromatic dispersion compensating fiber. Another stage of compensation, chromatic dispersion slope compensation must be used to compensate this variation of the total chromatic dispersion. Unfortunately, using the above dispersion compensation techniques in a WDM system will result in losses, Example: The DCF of -2040 ps/nm-km has total loss of 10 dB or more.

Nonzero-dispersion fibers (NZ-DSF)(or G.655 according to the ITU standard) have been developed to reduce the pulse spreading due to chromatic dispersion, and also to reduce penalties due to nonlinearities. NZ-DSFs are designed to have a small nonzero value of the dispersion in the 1550 nm wavelength region, and are used on many recently implemented WDM systems to replace the existing standard single mode fibers; this eliminates the need for dispersion compensation fibers.

#### D. Polarization mode dispersion (PMD)

It is caused by the difference of propagation velocities of light in the orthogonal polarization states of the transmission medium. Like fiber dispersion, PMD causes the transmitted optical pulse to spread out due to the polarization modes traveling at different speeds; this can scramble the signal [3], [7]. This often occurs at high data rates of 10 Gb/s or more per wavelength channel.

The time-average differential time delay between two orthogonal polarization states of the transmission medium is expressed as:

$$\Delta_{\Gamma} = D_{PMD} \sqrt{L} \quad (4)$$

Where  $\Delta_{\Gamma}$  is called the differential group delay (DGD), L is the link length, and  $D_{PMD}$  is the fiber PMD parameter, measured in ps/ $\sqrt{km}$ . The PMD parameter for a typical fiber lies between 0.5 and 2 ps/ $\sqrt{km}$ .

However, carefully constructed new fibers have PMD as low as 0.05 to 0.1 ps/ $\sqrt{km}$ . For the PMD of 0.1 and 0.5 ps/ $\sqrt{km}$ , a data rate of 10 Gb/s can be transmitted up to the maximum distance of 400 km and 10,000 km respectively, as is proved in [7] by the equation (5)

$$\Delta_{\Gamma} = B \sqrt{\sum_{K=1}^M D_{PMD}(k)^2 x L(k)} \quad (5)$$

Where B is the bit rate, k is number of spans, and M = fiber

span. Equalization can be used to compensate for PMD, normally for a data rate of 10 Gb/s, the equalization is carried out in the electronic domain.

#### E. Non-Linear effects

The above analyses of system impairments were made by assuming linearity in the WDM system, which operates at moderate power (a few milliwatts) and at data rates up to 2.5 Gb/s. However, at higher data rates such as 10 Gb/s and above or higher transmitted powers, it is important to consider the effect of non-linearity in the WDM system [8]-[12]. The non-linear effects are briefly discussed as follows: Stimulated Raman scattering is caused by the interaction of the optical signal with silica molecules in the fiber. This interaction can lead to transfer of power from lower wavelength channels to higher wavelength channels; Stimulated Brillouin scattering is caused by the interaction between the optical signal and acoustic waves in the fiber. This interaction can cause the power from the optical signal to be scattered back towards the transmitter.

Self-and cross-phase modulation and four-wave mixing are caused because, in an optical fiber, the index of refraction depends on the optical intensity of signals propagating through the fiber. Self-phase modulation is caused by the variations in the power of an optical signal and results in variations in the phase of the signal. Cross-phase modulation is due to a change in intensity of a signal propagating at a different wavelength. Four-wave mixing occurs when two or more optical signals (wavelengths) mix in such a way that they produce new optical frequencies called sidebands, which can cause interference if they overlap with the frequencies of a signal.

## IV. SYSTEM PERFORMANCE

#### A. The Bit error rate

This is the ratio of corrupted bits to total bits transmitted that occur between the transmitter and the receiver. The required BER for high-speed optical data communications is in the range of  $10^{-9}$  to  $10^{-15}$ , a typical value is  $10^{-12}$ , the BER of  $10^{-12}$  corresponds to one allowed bit error for every terabit of data transmitted on average. The BER is difficult to measure, and more difficult to simulate directly. Therefore the BER is estimated indirectly via measurement of the Q value, which determines the particular receiver sensitivity of a WDM system.

The receiver sensitivity is the average optical power required to achieve a certain bit error rate at a particular data rate, it is usually measured at a bit error rate of  $10^{-12}$  for a good WDM system performance. The BER can be approximately related to Q [6] by the equation (6)

$$BER = \frac{1}{Q\sqrt{2\pi}} \exp\left(-\frac{Q^2}{2}\right) \quad (6)$$

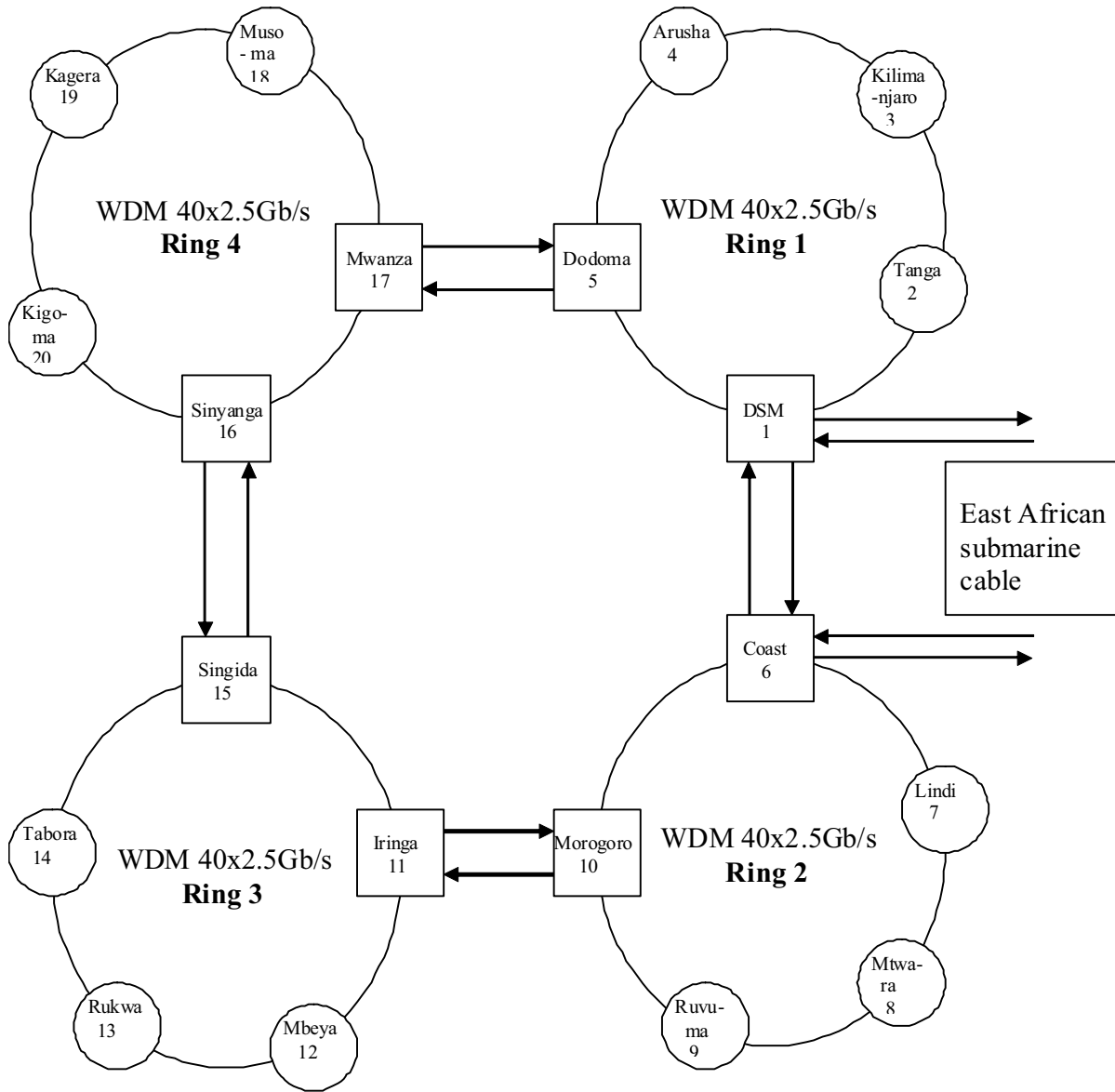

Fig. 1 Block diagram of optical WDM network in Tanzania

**B. Signal to noise ratio (OSNR)**

It is the ratio of the average received signal power to the average optical noise power. For a WDM system that consists a chain of amplifiers along the span, and each amplifier installed to compensate for the loss of each span, the OSNR is expressed in [6] as:

$$OSNR \text{ (dB)} = 58 + P_{out} - L_{span} - NF - 10 \log(N_{amp}) \quad (7)$$

Where  $P_{out}$  (in dBm) is the optical amplifier output power per channel launched into the span,  $NF$  is the noise figure of amplifier in dB,  $L_{span}$  is the product of the span loss in (dB), and  $N_{amp}$  is the number of spans. As we have seen from the equation (7), increasing the amplifier output power,

decreasing the noise figure, or reducing the span loss will increase the OSNR in the WDM system.

However increasing an EDFA amplifier output power will increase the noise figure, and four wave mixing, since the four wave mixing tends to increase with the square of output power. Furthermore, reducing the span loss will increase the system cost because it will require twice the number of EDFA amplifiers in the system.

The Distributed Raman amplifiers (DRA) using a backward propagating pump [3] can be installed in the final length of each span to pump backward toward the span. This has the advantage over using high span input powers, that the power is low along the fiber, so the four-wave mixing is reduced whilst OSNR is maintained. Also, because the amplification occurs before the end of the span, the Raman amplification

can have a negative effective noise figure, when compared with an EDFA amplifier at the end of the span.

The OSNR must be kept high to achieve the required system performance of WDM system, which is most often a bit-error rate (BER) of  $10^{-12}$ , as we have seen above. Since a BER is estimated indirectly by measurement of the Q value, the OSNR [6] can be evaluated from Q using equation (8)

$$Q_{dB} = OSNR_{dB} + 10 \log \left( \frac{B_o}{B_E} \right) \quad (8)$$

Where  $B_o$  is the optical bandwidth of the receiver and  $B_E$  is the electrical bandwidth of the receiver post detection filter.

## V. SIMULATION RESULTS

The simulation results of Fig. 2 shows that, when a data rate of 2.5 Gb/s is transmitted to a 3000 km distance in the WDM system, the BER of  $10^{-12}$  corresponds to the receiver sensitivity of -30.5 dBm, which is adequate for system performance and results in an open eye diagram for the signal as shown in Fig. 3. While Fig. 4 shows that, when a data rate of 10 Gb/s is transmitted to a 3000 km distance in the WDM system, the BER for each signal channel are different and undefined, which cause the receiver sensitivity not to be easily estimated due to system impairment affects in the WDM system. This results in a closed eye diagram for the signal as shown in Fig. 5, and is not enough for system performance.

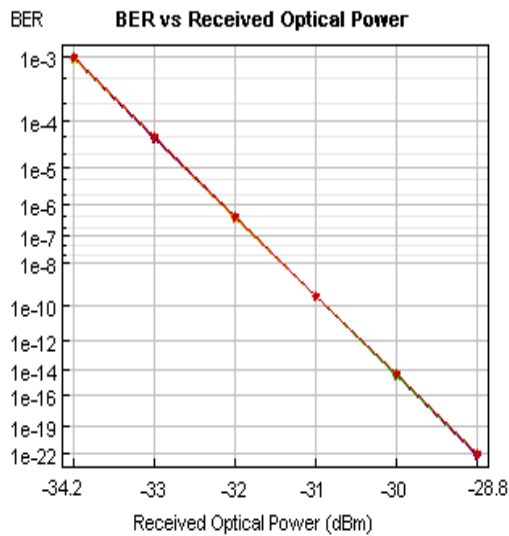

Fig. 2 Receiver sensitivity for a data rate of 2.5 Gb/s

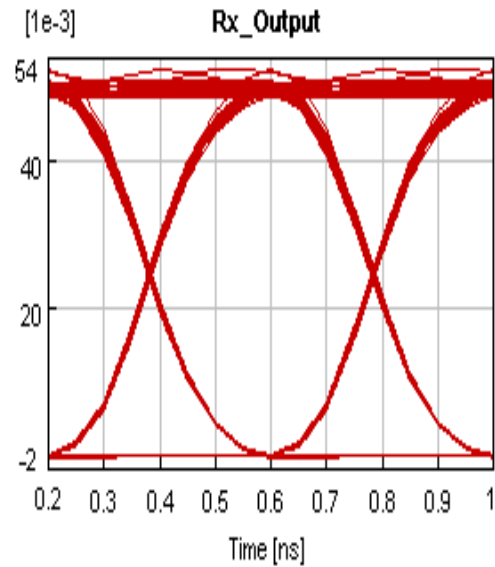

Fig. 3 Eye diagram for a data rate of 2.5 Gb/s

Fig. 6 and 7, shows that the transmission of 2.5 Gb/s and 10 Gb/s respectively, with a span length of 120 km between amplifiers along the 3000 km distance. Fig. 6, shows that for a data rate of 2.5Gb/s, the OSNR is approximately to 30 dB, which is high and sufficient for system performance, and also results in an open eye diagram for the signal as shown in Fig. 3. While Fig. 7, shows that for a data rate of 10 Gb/s, the OSNR is lower at approximately 13dB, which is not enough for system performance, and also results in a closed eye diagram for the signal, as shown in Fig. 5.

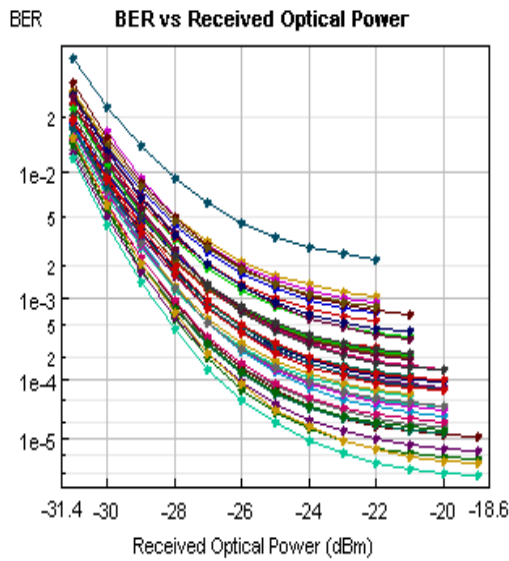

Fig. 4 Receiver sensitivity for a data rate of 10 Gb/s

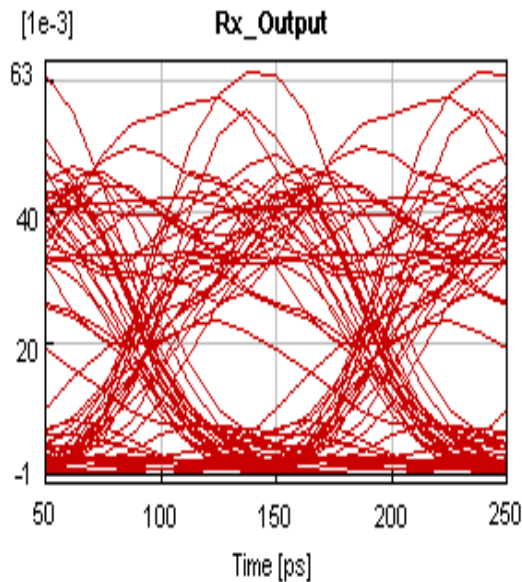

Fig. 5 Eye diagram for a data rate of 10 Gb/s

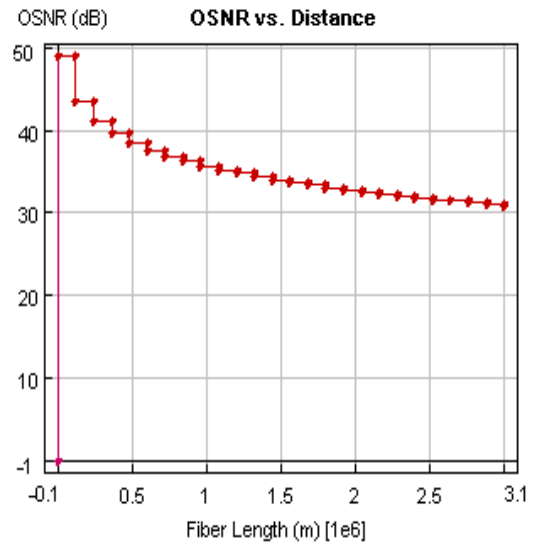

Fig. 6 OSNR. Vs. 3000 km distance for a data rate of 2.5 Gb/s

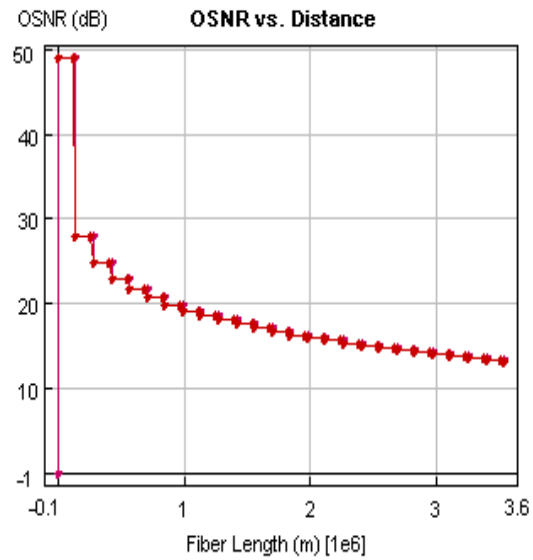

Fig. 7 OSNR. Vs. 3000 km distance for a data rate of 10 Gb/s

## VI. CONCLUSION

The WDM system is the most preferred technology and a very attractive commercial proposition for implementing the Internet infrastructure around the world. We have shown that to implement the WDM system by using the existing single mode (i.e., standard single mode) fibers can limit the system performance especially when transmitting a data rate of 10 Gb/s or more due to the system impairment effects. We have also discussed briefly how to use compensation techniques in order to reduce the system impairments in the WDM systems. However, most compensation will lead to more loss and high cost in the WDM system. Therefore, it is essential for a WDM system in Tanzania to use only a data rate of 2.5 Gb/s per wavelength channel, which is adequate for WDM system performance, as we have seen in the simulation results. It is also sufficient to meet Internet traffic demand in Tanzania.

REFERENCES

- [1] Tanzania Ministry of communication and Transport (2005), "Technical report on the Feasibility study for implementation of the national backbone infrastructure."
- [2] East African Submarine System (EASSy) available online from: <http://www.eassy.org> [Accessed on May, 2008].
- [3] R.Ramaswami and K.Sivarajan, Optical Networks: A Practical Perspective, Morgan Kaufmann, 1998.
- [4] I.kaminow and T.Li. Optical Fiber Telecommunication, IVA, Academic press, 2002.
- [5] Govind P.Agrawal, Fiber Optic Communication Systems, 2nd Edition, 1997.
- [6] I.kaminow and T.Li. Optical Fiber Telecommunication, IVB, Academic press, 2002.
- [7] J.Strand, A.L.Chiu and R.Tkach, "Issues for routing in the optical layer, IEEE Communications Magazine, February 2001."
- [8] G.P.Agrawal, Nonlinear Fiber Optics, Academic Press, San Diego, 1995.
- [9] C.Siva Ram Murthy and M.Gurusamy, WDM Optical Networks: Concepts, Design, and Algorithms, Prentice Hall, 2002.
- [10] J.P.Gordon, and L.F.Mollenauer, "Effects of fiber nonlinearities and amplifier spacing on ultra-long distance transmission, " J.Lightwave Technol., vol. 9(2), pp. 170-173, 1991.
- [11] D.Marcuse, A.R.Chraplyvy, R.W.Tkach, "Dependence of cross-phase modulation on channel number in fiber WDM systems," J.Lightwave.vol, 12(5), pp.885-890, 1994.
- [12] R.W.Tkach, A.R.Chraplyvy, F.Forgheri, A.H.Gnauck and R.M, Derosier, "Four-photon mixing in high-speed WDM system, " J.Lightwave Technol, vol. 13(5), pp.841-849, 1995.