

Effects of Material Properties of Warhead Casing on Natural Fragmentation Performance of High Explosive (HE) Warhead

G. Tanapornraweekit, W. Kulsirikasem

Abstract—This research paper presents numerical studies of the characteristics of warhead fragmentation in terms of initial velocities, spray angles of fragments and fragment mass distribution of high explosive (HE) warhead. The behavior of warhead fragmentation depends on shape and size of warhead, thickness of casing, type of explosive, number and position of detonator, and etc. This paper focuses on the effects of material properties of warhead casing, i.e. failure strain, initial yield and ultimate strength on the characteristics of warhead fragmentation. It was found that initial yield and ultimate strength of casing has minimal effects on the initial velocities and spray angles of fragments. Moreover, a brittle warhead casing with low failure strain tends to produce higher number of fragments with less average fragment mass.

Keywords—Detonation, Material Properties, Natural Fragment, Warhead

I. INTRODUCTION

KILLING performance of warhead is of the main interest in the subject of warhead design. Generally, the performance of blast fragmentation warhead can be assessed by the total kinetic energy of fragments produced from the warhead detonation. These include mass and velocity of fragments. To achieve high kinetic energy, it is necessary to maximize either mass or velocity of fragment. However, design a warhead to achieve lump fragment mass would decrease the total number of natural fragments. Therefore, the best practice of fragment warhead design is to balance the number and size of fragments.

II. LITERATURE REVIEW

Reference [1] conducted a series of fragmentation warhead tests by varying the ratios of tensile strength and yield strength of warhead steel cases (R_m/R_v). They found that the steel case with larger ratio of R_m/R_v generates greater number of fragments but with less mean mass. This phenomenon can be explained as a consequence of warhead expansion during the detonation. Reference [1] also found that the relationship between relative volume rise and relative case thickness can be

described by $t_i/t_0 = (V_i/V_0)^{-0.5}$ during the warhead case expansion. When the ratio R_m/R_v rises, the ratio V_i/V_0 increases whilst the ratio t_i/t_0 decreases. This relationship results in greater fragment number with less average fragment mass.

Reference [2] investigated the effects of casing toughness on fragmentation warhead performance. The toughness of a material is the maximum amount of energy absorbed before fracturing. Therefore, a ductile material tends to have high toughness. Two types of steel with the same hardness but different toughness were used for the tested warheads. Pit tests were conducted to investigate fragment mass distribution of the cylindrical warheads. Test results revealed that casing with higher toughness generates higher number of small fragments but lower number of large fragments.

III. METHODOLOGY

A classical Gurney's equation [3] and Shapiro's formula [4] are widely used to determine the initial velocity and spray angle of fragment. But these analytical approaches have limitations that they do not take into account on the effects of the material properties of casing, i.e. tensile strength, yield strength and failure strain. To investigate these effects either a series of field tests or a series of numerical simulation models is required. This study employs the simulation approach using a commercial finite element (FE) code, Autodyn. In addition, the simulation results of different analysis cases were compared to the analytical results obtained using a modified Gurney's equation, Shapiro's formula, and Mott's distribution. A dummy warhead in Fig. 1 was chosen as a case study.

A. Analytical Calculation

In this study, the modified Gurney's equation was employed to calculate initial velocities of natural fragments resulted from the detonation of warhead. It can be seen from (1) that initial velocity of fragment depends only on the values of $\sqrt{2E}$ (Gurney velocity coefficient) and C/M (charge weight per metal mass ratio). Apart from the initial velocities of fragments, the spray angles of those fragments can be determined using Shapiro's formula [4] as presented in (2). The parameters in (2) are described in Fig. 2 where V and V_0 are the initial velocity of fragment and the detonation velocity of explosive, respectively.

G. Tanapornraweekit is with the Defence Technology Institute (Public Organization), Nonthaburi, Thailand (phone: +662-980-6198 ext. 614; fax: +662-980-6198 ext. 731; email: ganchai.t@dti.or.th).

W. Kulsirikasem is with the Defence Technology Institute (Public Organization), Nonthaburi, Thailand (phone: +662-980-6198 ext. 828; fax: +662-980-6198 ext. 731; email: weerachart.k@dti.or.th).

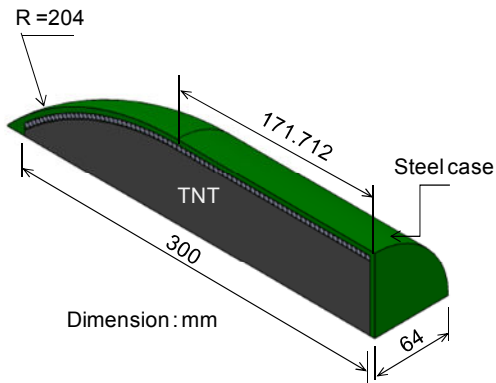

Fig. 1 Shape and dimension of a dummy warhead

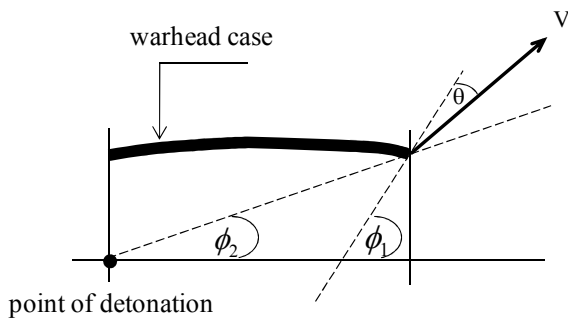

Fig. 2 Spray angle of fragment

$$V = \sqrt{\frac{2E}{\frac{M}{C} + \frac{1}{2}}} \quad (1)$$

$$\tan \theta = \frac{V}{2V_0} \cos\left(\frac{\pi}{2} + \phi_2 - \phi_1\right) \quad (2)$$

where

- V Initial velocity of fragment
- V_0 Detonation velocity of explosive
- $\sqrt{2E}$ Gurney's constant
- M Mass of metal
- C Mass of charge

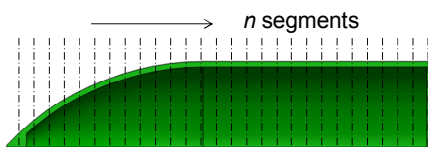

Fig. 3 Subdivide of warhead into n segments

To obtain the calculated initial velocities and spray angles of fragments at each location of warhead casing, the dummy warhead was divided into a number of small segments as shown in Fig. 3. The ogive part of warhead consists of forty segments whilst the cylindrical part of warhead consists of twenty segments.

It is also important to determine the fragment mass distribution, i.e. average fragment mass and number of fragments, produced from detonation of the warhead so as to evaluate its kill performance. Mott [5] suggested an analytical formula to obtain the distribution of fragment mass as shown

in (3) and (4).

$$N(m) = \frac{M_0}{2M_k^2} e^{-\left(\frac{m^{1/2}}{M_k}\right)} \quad (3)$$

$$M_k = Bt^{5/16} d^{1/3} \left(1 + \frac{t}{d}\right) \quad (4)$$

where

- $N(m)$ Number of fragments of weight $> m$
- M_0 Mass of a warhead case
- M_k Distribution factor
- m Fragment mass
- B Constant that is specific for a given explosive-metal pair
- t Thickness of casing
- d Inside diameter of a warhead case

B. Numerical Simulation

In order to model the Fluid-Structure-Interaction (FSI) problem such as the warhead detonation presented in this paper, Arbitrary Lagrangian-Eulerian (ALE) solver, which is capable of handling both Lagrangian and Eulerian meshes, best suits for this application. In this study, the Lagrange meshes are used to model the warhead casing while the Euler meshes are used to model air and explosives. For this reason, Autodyn, which is an explicit finite element (FE) code, was employed in this research. Lagrange meshes with Johnson Cook strength model were employed to represent casing material for all analysis cases. This strength model is shown in (5).

$$\bar{\sigma} = \left[A + B(\bar{\epsilon})^n \right] \left[1 + C \ln \left(\frac{\dot{\bar{\epsilon}}}{\dot{\bar{\epsilon}}_0} \right) \right] \left[1 - \left(\frac{T - T_0}{T_{melt} - T_0} \right)^m \right] \quad (5)$$

where

- A Initial yield stress
- B Hardening modulus or hardening constant
- n Hardening exponent
- C Strain rate constant
- M Thermal softening exponent
- T_{melt} Melting temperature (K)
- T Current temperature (K)
- T_0 Reference temperature (K)
- $\dot{\bar{\epsilon}}_0$ Reference strain rate (/s)

To investigate the effects of material properties of casing on the warhead fragmentation performance, yield strength, ultimate strength and failure strain were varied in seven analysis cases. Material parameters in these analyses are listed in Table I. Other parameters in Johnson Cook strength model shown in Table II were kept constant for all analysis cases. Fig. 4 to Fig. 6 illustrate stress and effective plastic strain curves of casing material used in analysis cases 1 to 7.

TABLE I

VARIAION OF MATERIAL PROPERTIES OF CASING IN ANALYSIS CASES 1 TO 7

Analysis case	Yield Strength, MPa	Ultimate Strength, MPa	Failure Strain
Case 1	700	1,035	0.2
Case 2	700	1,200	0.2
Case 3	700	2,000	0.2
Case 4	400	1,035	0.2
Case 5	900	1,035	0.2
Case 6	700	1,035	0.05
Case 7	700	1,035	1

TABLE II

PARAMETERS IN JOHNSON COOK STRENGTH MODEL

Parameter in Johnson Cook Strength Model	VALUES
n	0.26
C	0.014
M	1.03
T _{melt}	1,793
T	300
T ₀	300
$\dot{\epsilon}_0$	0.0001

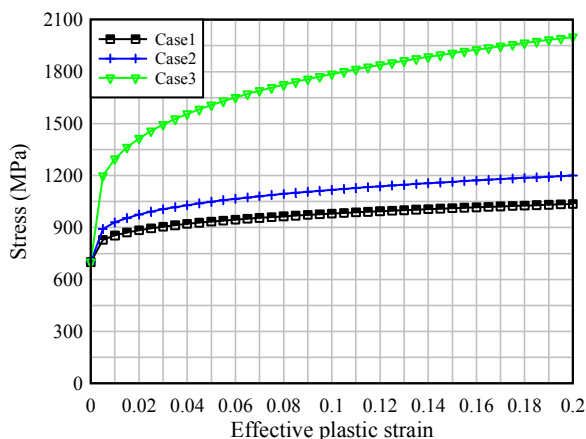

Fig. 4 Stress-strain curves of casing for analysis cases 1 to 3

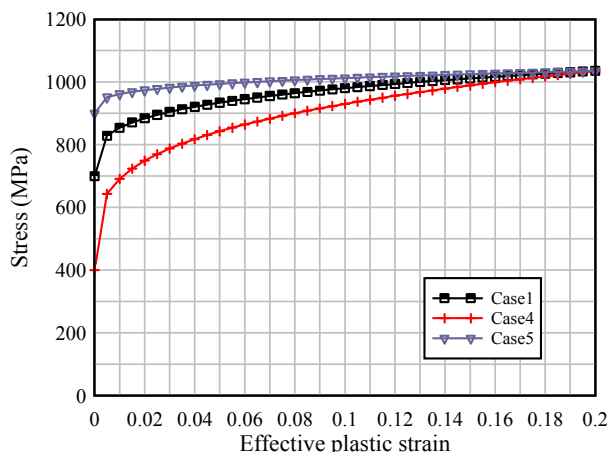

Fig. 5 Stress-strain curves of casing for analysis cases 1, 4 and 5

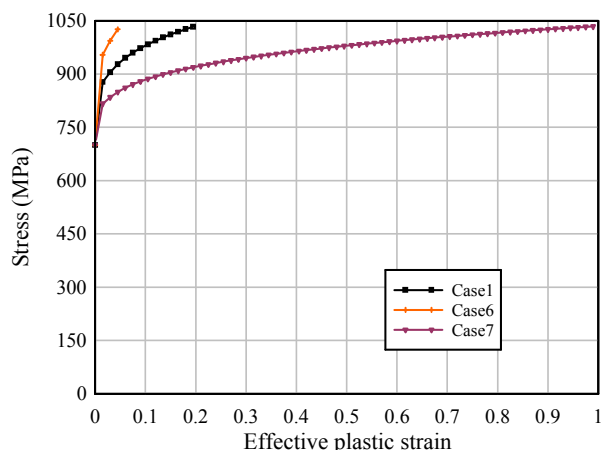

Fig. 6 Stress-strain curves of casing for analysis cases 1, 6 and 7

Air and explosive material are modeled using Euler solver where it is able to treat multi-material effects in one FE mesh. A standard equation of state (EOS) JWL (Jones-Wilkins-Lee) [6] was employed to describe the adiabatic expansion of detonation products. Equation (6) presents the EOS JWL adopted in this study. The equation represents pressure as a function of volume (V) and energy (E).

$$p = A \left(1 - \frac{\omega}{R_1 V} \right) e^{-R_1 V} + B \left(1 - \frac{\omega}{R_2 V} \right) e^{-R_2 V} + \frac{\omega E}{V} \quad (6)$$

where

- A and B pressure coefficients
- R₁ and R₂ principal and secondary eigenvalues
- ω fractional part of the normal Tait equation
- adiabatic exponent

Fig. 7 presents the whole domain of the FE mesh analyzed in this study. It is necessary to create air domain to be large enough to allow an expansion of warhead during detonation

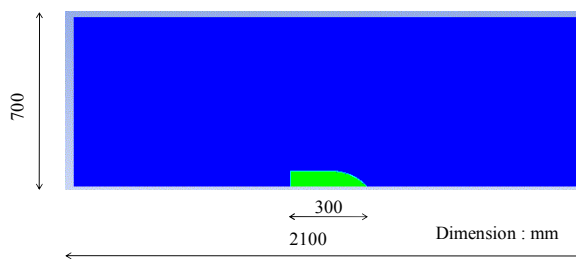

Fig. 7 Domain of air, explosive, and warhead casing in FE analysis

in which a coupling between warhead casing and air still exists. Flow out boundary condition, which is available in Autodyn, was applied to the boundary of air domain. This type of boundary condition prevents a reflection of blast waves at the edge of air domain.

IV. ANALYSIS RESULTS

The numerical results from all analysis cases indicate that the material properties of warhead casing; i.e. initial yield strength, ultimate strength and failure strain do not significantly affect to the fragment velocities and fragment spray angles of warhead. Fig. 8 to Fig. 14 present comparison of fragments velocity vectors obtained from a series of analytical calculation and numerical simulation using Autodyn. It should be emphasized again that only the latter approach considers material properties of casing in the analyses. It is noted that each velocity vector shown in Fig. 8 to Fig. 14 is the

maximum velocity at each section of warhead. Therefore each velocity vector does not arise concurrently. The velocity profiles shown in Fig. 8 to Fig. 14 are different from the velocity profile shown in Fig. 15 where all the velocity vectors are at a specific time after detonation ($t=0.045$ msec in Fig. 15).

It can be observed that there are some difference in the velocity vectors of fragments in the nose cone part of warhead between the numerical results and the analytical results. The velocities of fragments in this part reported from Autodyn are slightly lower than those obtained from analytical solution. The velocity vector at the end of cylindrical part obtained from Autodyn seems to have higher horizontal component compared to those reported from analytical calculation. However, the velocity vectors of fragment in the cylindrical part obtained from analytical calculation agree well with those obtained from numerical results.

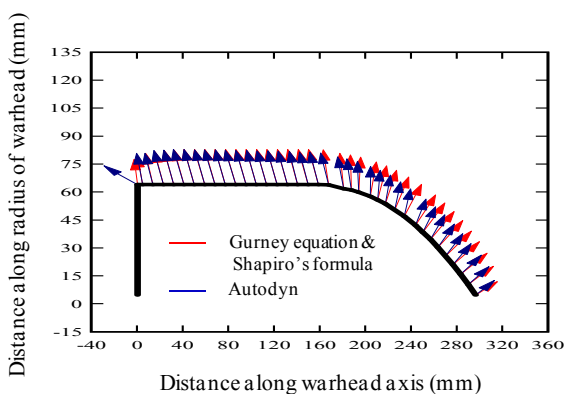

Fig. 8 Comparison of velocity vectors of fragments of warhead obtained from analytical calculation and numerical analysis case1

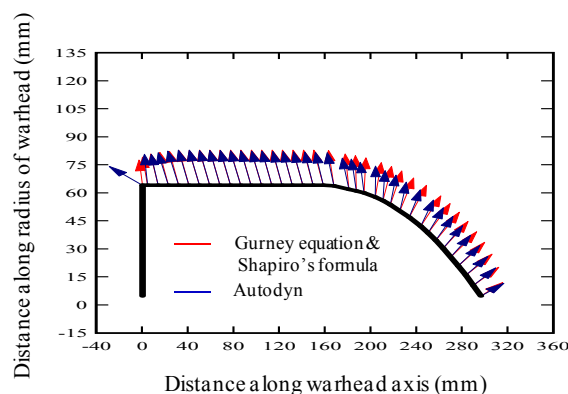

Fig. 9 Comparison of velocity vectors of fragments of warhead obtained from analytical calculation and numerical analysis case2

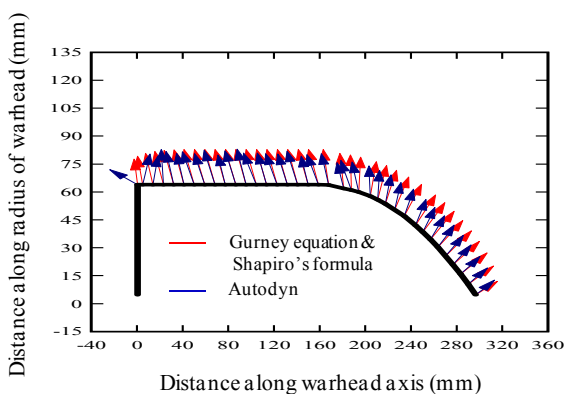

Fig. 10 Comparison of velocity vectors of fragments of warhead obtained from analytical calculation and numerical analysis case3

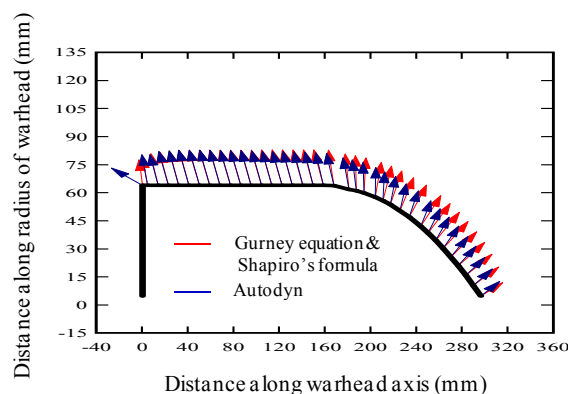

Fig. 11 Comparison of velocity vectors of fragments of warhead obtained from analytical calculation and numerical analysis case4

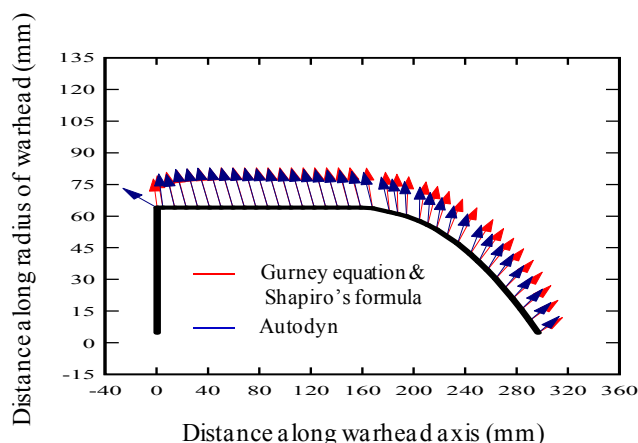

Fig. 12 Comparison of velocity vectors of fragments of warhead obtained from analytical calculation and numerical analysis case5

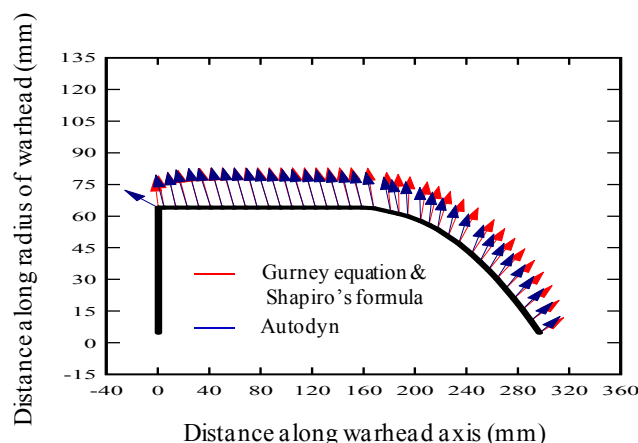

Fig. 13 Comparison of velocity vectors of fragments of warhead obtained from analytical calculation and numerical analysis case6

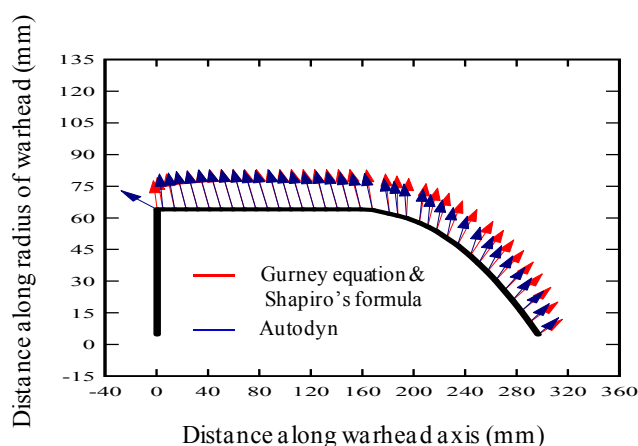

Fig. 14 Comparison of velocity vectors of fragments of warhead obtained from analytical calculation and numerical analysis case7

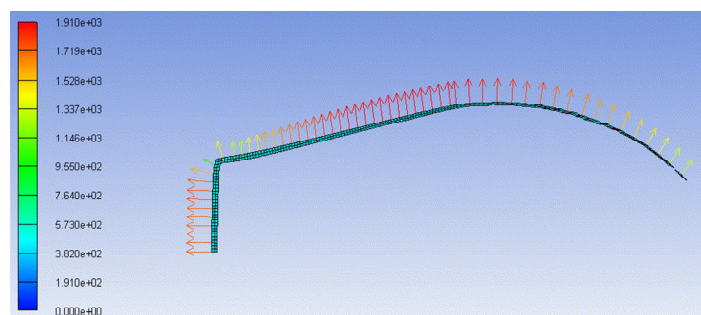

Fig. 15 Velocity vectors obtained from Autodyn at time = 0.045 msec

TABLE III

COMPARISON OF AVERAGE FRAGMENT VELOCITIES AND AVERAGE FRAGMENT SPRAY ANGLES OBTAINED FROM ANALYTICAL AND NUMERICAL METHODS

Analysis case	Average velocity from analytical calculation	Average velocity from numerical simulation (%difference)	Average spray angle from analytical calculation	Average spray angle from numerical simulation (%difference)
Case 1	1884	1866.7 (-0.92%)	85.8°	89.5° (4.31%)
Case 2		1867.3 (-0.89%)		88.4° (3.03%)
Case 3		1805.3 (-4.18%)		89.1° (3.85%)
Case 4		1895.4 (0.61%)		89.3° (4.08%)
Case 5		1885.8 (0.10%)		89.3° (4.08%)
Case 6		1894.9 (0.58%)		89.5° (4.31%)
Case 7		1841.8 (-2.24%)		89.2° (3.96%)

Table III summarizes the results obtained from Autodyn for all the analysis cases in comparison to the results obtained using Gurney's equation and Shapiro's formula. It can be seen that the effects of material properties of the warhead casing on the velocity and spray angle of fragment are within 5% from those of the model without consideration of material properties.

A. Effects of Ultimate Strength of Warhead Casing

The effects of ultimate strength of warhead casing on the characteristics of warhead fragmentation can be investigated

through the results of analysis cases 1 to 3. Analysis case 1 with the lowest ultimate strength of warhead casing gives the highest number of fragment and the highest average kinetic energy per fragment whilst the casing with the highest ultimate strength gives the lowest number of fragment and the lowest average kinetic energy per fragment.

B. Effects of Initial Yield Strength of Warhead Casing

Analysis results of case 1, case 4, and case 5 can be used to investigate the effects of initial yield strength of warhead

casing. Analysis case 4 gives the highest number of fragments and the highest total kinetic energy of all fragments compared to those resulted from analysis cases 1 and 5. These results imply that the warhead casing with the lowest initial yield strength performs better than those built from the high strength material.

C. Effects of Failure Strain of Warhead Casing

Effects of failure strain of casing material can be investigated through the analysis results from analysis case 1, case 6, and case 7. It can be seen that the analysis case 6 with the lowest failure strain gives the highest number of fragments compared to those produced from the case material with higher failure strain. However, the highest average kinetic energy per fragment is obtained from the casing with failure strain of 0.2.

D. Number of Fragments and Average Fragment Mass

Table IV summarizes the number of fragments and average fragment mass resulted from numerical simulation of analysis cases 1 to 7. It can be seen that analysis case 6 with the lowest failure strain of casing generates the highest number of fragments compared to other analyses. The highest total kinetic energy is also from analysis case 6. However, the average kinetic energy per fragment of this analysis case is not the highest due to its highest number of fragments. It is noted that this average kinetic energy is the energy of fragment when it starts to fly from the warhead. In order to evaluate whether it is sufficient to damage/penetrate a target, the residual fragment velocity at distance "s" from the detonated warhead has to be assessed [7].

An average fragment mass and total number of fragments can also be calculated analytically using Mott's distribution. It is found that by using Mott's distribution, where the material properties of casing are not taken into account, the total number of fragments is 529 and the average fragment mass is 5.26 gram. The calculated number of fragment using Mott's distribution agrees well with the numerical results of the analysis case 6 where the casing has the failure strain of 0.05. However, the calculated average fragment mass is somewhat lower than those obtained from all numerical analyses.

TABLE IV
 FRAGMENT CHARACTERISTICS OF DUMMY WARHEADS OBTAINED FROM
 NUMERICAL ANALYSES

Analysis cases	Number of fragments	Average fragment mass (gram)	Total kinetic energy (kJ)	Average kinetic energy/fragment (kJ)
Case 1	451	7.64	63,343	140.45
Case 2	446	7.71	62,519	140.18
Case 3	444	7.71	55,633	125.30
Case 4	453	7.62	63,667	140.55
Case 5	446	7.71	62,794	140.79
Case 6	537	7.00	73,497	136.87
Case 7	447	7.65	59,527	133.17

V. CONCLUSION

This paper presents a series of numerical studies of characteristics of warhead fragmentation. The primary objective is to investigate the effects of material properties of casing on the initial velocities and spray angles of fragments. A total number of fragment and an average fragment mass resulted from warhead detonation are also investigated. The simulation results reveal that yield strength, ultimate strength and failure strain of casing do not have significant effects on the initial velocities and spray angles of fragments. In addition, a total number of fragment and an average fragment mass seem to be not affected by both yield and ultimate strength of casing. However, it was found that the more brittle of material the more number of fragments.

REFERENCES

- [1] O. B. Zecevic, J. Terzic and A. Catovic, "Influence of warhead case material on natural fragmentation performances," in 12th DAAAM International Symposium Vienna, Austria, 2004.
- [2] M. T. Shahraini, "Casing toughness effect on anti-air fragmentation warhead performance," in 23rd International Symposium on Ballistics, Tarragona, Spain, 2007, pp. 209-213.
- [3] P. Cooper, Explosives Engineering. Wiley-VCH 1996, pp. 385-394.
- [4] Elements of terminal Ballistics, Part One, Introduction, Kill Mechanics and Vulnerability, Washington, D.C., 1962, pp. 4-175.
- [5] N. F. Mott, "Fragmentation of high explosive shells, A theoretical formula for the distribution of weights of fragments," 1943.
- [6] J. A. Zukas and W. P. Walters, Explosive Effects and Applications. New York: Springer, 1997, pp. 89-91.
- [7] G. Tanapornraweekit and W. Kulsirikasem, "Lethality assessment of high explosive (HE) warhead with preformed fragments," in 26th International Symposium on ballistics, Miami, FL, USA, 2011, to be published.