

Modeling of the Process Parameters using Soft Computing Techniques

Miodrag T. Manić, Dejan I. Tanikić, Miloš S. Stojković, Dalibor M. Đenadić

Abstract—The design of technological procedures for manufacturing certain products demands the definition and optimization of technological process parameters. Their determination depends on the model of the process itself and its complexity. Certain processes do not have an adequate mathematical model, thus they are modeled using heuristic methods. First part of this paper presents a state of the art of using soft computing techniques in manufacturing processes from the perspective of applicability in modern CAx systems. Methods of artificial intelligence which can be used for this purpose are analyzed. The second part of this paper shows some of the developed models of certain processes, as well as their applicability in the actual calculation of parameters of some technological processes within the design system from the viewpoint of productivity.

Keywords—fuzzy logic, manufacturing, neural networks

I. INTRODUCTION

MANUFACTURING is extremely complex process which depends on many factors and their intermediate correlations. It is almost impossible to encapsulate it within just one model. Optimization methods in manufacturing processes, being a vital tool for continual improvement of output quality of products and processes, include modeling of input-output and in-process parameters relationship and determination of optimal cutting conditions. To design and implement an effective process control for manufacturing operation by parameter optimization, a manufacturer seeks to balance between quality and cost at each stage of operation [1].

Artificial neural networks (ANN), fuzzy logic systems (FLS), and combination of these systems are the most often used artificial intelligence based techniques (often called soft computing techniques) for modeling and optimization of complex systems. The reasons are numerous. First of all, the mentioned systems have relatively simple mathematical background, dealing with numerous parallel mathematical operations. Taking in consideration the speed of contemporary computers, the operating time is minimized. Secondly, manipulating with their knowledge basis is very simple. The

knowledge of mathematical programming is not a necessary condition for successful implementation of these systems. Finally, the simulations can be performed on the conventional computer platforms, so investments in new equipment are minor.

Significant application of ANN and FLS in manufacturing processes began at the end of 1980s. The field of use is very wide, covering almost all manufacturing areas, which is further described in the following sections.

II. STATE OF THE ART

A. Product Design

In the large number of cases, there exist some geometrical and/or technological features of the old product, which should be kept in the new one. Retrieval of 3D CAD models is becoming very important for achieving design reuse. The existing methods for retrieval of 3D CAD models are very few and far from the requirements of design reuse. Venugopal and Narendran developed associative memory based model, which uses Hopfield neural network, to develop a design retrieval system [2]. The similar system can be realized using ANN with backpropagation, instead of Hopfield network [3].

Investigations on the potential of soft computing techniques and comparing them with the statistical techniques in meta-modeling provided some recommendations about their appropriate use. Beside meta-modeling, soft computing techniques may be combined with expert and knowledge-based systems [4].

The research of Chan *et al.* [5] is aimed at developing an integrated methodology based on FEM simulation and ANN to approximate the functions of design parameters and evaluate the performance of designs in such a way that the optimal design can be identified. To realize this objective, an integrated FEM and ANN methodology is developed. In this methodology, the FEM simulation is first used to create training cases for the ANN(s), and the well-trained ANN(s) is used to predict the performance of the design.

Multiple criteria decision-making methods can solve a variety of real-world problems, one of which is the selection of conceptual design. As conceptual design tends to be a fuzzy problem in nature, a fuzzy approach for the Analytic Hierarchy Process is presented by Yeo *et al.* [6]. Fuzzy logic has also been applied to design activities other than knowledge representation, e.g. for cognitive support in reverse engineering [7] and for decision making in demanding domains, such as conceptual design [8].

M. T. Manić, Mechanical engineering Faculty of the University of Niš, Aleksandra Medvedeva 14, 18000 Niš, Serbia (phone: +381-18-588-229; fax: +381-18-588-244; e-mail: miodrag.manic@masfak.ni.ac.rs).

D. I. Tanikić, University of Belgrade, Technical faculty of Bor (e-mail: dtanikic@tf.bor.ac.rs).

M. S. Stojković, Mechanical engineering Faculty of the University of Niš (e-mail: miloss@masfak.ni.ac.rs).

D. M. Đenadić, University of Belgrade, Technical faculty of Bor (e-mail: ddjenadic@tf.bor.ac.rs).

B. Process Planning

One of the pioneering works in implementation of ANN for process planning was presented by Osakada and Yang [9]. ANN, working together with an expert system, is used for improving the cold forging process. A three-layer ANN is used to map certain number of rotational symmetrical parts with required technological processes. The basic rotational features are transformed in black-white pictures, and introduced to the backpropagation ANN. After the learning phase, this network can be used for forging method planning, for similar parts.

A perceptron neural network can be used for intelligent features recognition, i.e. features recognition from the CAD model, which represents the first step in automated process planning [10].

A study of the implementation of artificial neural networks applied to feature recognition and computer aided process planning was proposed by Ding and Matthews [11]. The authors consider the factors which define the function of a neural network specifically: the net topology, the input node characteristic, the learning rules and the output node characteristics.

ANNs can also be used in automated choice of technological parameters of cutting tools, such as: the angle of inclination, rake angle, tool nose radius etc. [12].

A hybrid procedural and knowledge-based approach, based on artificial intelligence, addresses both: classic feature interpretation and also feature representation problems. STEP designs are presented as case studies in order to demonstrate the effectiveness of the proposed model [13].

C. Scheduling

Machines are production resources where certain operations are realized by defined schedule. To achieve economic production, machine exploitation must be optimal (with minimal stops during the process). So, the problem is maximizing/minimizing of some functions with more or less constraint factors. The successful solver of this problem can be linear programming methods in corporation with ANN [14].

Vidal *et al.* [15] combine evolutionary computing and neural networks to reduce the impact of (i) the huge search space that the multi-objective optimization must deal with and (ii) the inherent problem of computing the processing times in a domain like custom manufacturing.

Karim *et al.* [16] consider the design of the multiple objective real-time scheduling problem of a multiple-part-type production system. Distributed and supervised continuous-flow control architecture has been proposed, based on fuzzy control theory. The objective is to balance the production process by adjusting the continuous production rates of the machines.

The intelligent multi-controller approach is efficient enough to be incorporated into the operation of a real time scheduling system. The multi-controller consists of three main parts: (i) a simulation-based training example generation mechanism, (ii) a data preprocessing mechanism, and (iii) a self-organizing map [17].

D. Optimization Problems

Many dynamic optimization problems appear in the real world. Solving these problems means finding strategies that can track the optimum as it moves in the search space. Cadenas *et al.* propose the use of a cooperative metaheuristic to cope with such problems. In his strategy, different metaheuristics cooperate under the supervision of a coordinator, who is able to control the cooperation using a collection of Support Vector Machine models and a fuzzy decision framework. The combination of these two techniques allows modifying the behavior of the strategy depending on the instance being solved [18].

An approach in a soft computing paradigm for the process parameter optimization of multiple-input multiple-output (MIMO) plastic injection molding process integrates Taguchi's parameter design method, back-propagation neural networks, genetic algorithms and engineering optimization concepts to optimize the process parameters [19].

An integrated optimization approach using an artificial neural network and a bidirectional particle swarm is proposed by Thitipong and Afzulpurkar [20]. The artificial neural network is used to obtain the relationships between decision variables. The bidirectional particle swarm is used to perform the optimization with multiple objectives. Finally, the proposed approach is used to solve a process parameter design problem. The results showed that proposed system can be used to solve complex process parameter design problems.

The work of Rao *et al.* [21] is aimed at optimizing the surface roughness of die sinking electric discharge machining (EDM) by considering the simultaneous effect of various input parameters. The experiments are carried out on various materials. The genetic algorithm concept is used to optimize the weighting factors of the ANN. Comparing the experimental and network model results shows that the developed model is within the limits of the agreeable error.

An energy consumption change forecasting system can be realized using fuzzy logic. The main goal is to reduce the uncertainty, inconvenience and inefficiency resulting from variations in the production factors. This approach helps the manufacturer forecast the energy consumption change in the plant when certain production input factors are varied [22].

E. Monitoring and Control of the Processes

Automatic data acquisition and simultaneous monitoring of several correlated quality variables are now widely adopted in manufacturing industries. A hybrid learning-based model for on-line analysis of out-of-control signals in multivariate manufacturing processes can recognize the type of unnatural pattern and classify major parameters for shift, trend and cycle and for each variable simultaneously [23].

Rangwala and Dornfeld [24] propose ANN based model of the manufacturing process, which uses adaptive control (comparing current ANN parameters with optimal values, gained from the synthesis module). This is a typical real time process control. ANN can also be a useful tool for cutting force prediction, during turning [25]. The input values of this

system are: yield stress, thermal characteristics of the workpiece and cutting conditions. Monitoring of the cutting forces during the metal cutting process is very important, knowing that this parameter is in tight correlation with following occurrences like tool wear, tool breakage, cutting temperature, self and forced oscillations, quality of the machined surface, etc.

Yu *et al.* [26] proposed a selective ANN ensemble approach, where several selected ANNs are jointly used to classify source(s) of out-of-control signals in multivariate processes. The timely location of the abnormal source(s) can greatly narrow down the negative consequences. The performance of the proposed model is analyzed in multivariate processes and it shows improved generalization performance that outperforms those of single NNs.

A feed forward back propagation ANN system can be used to investigate the influence of some parameters on the thrust force and cutting torque in the drilling processes [27]. The modeling results confirm the feasibility of the ANN and its good correlation with the experimental results.

The regression analysis and ANN models can be used for the prediction of tool–chip interface temperature in machining, depending on various cutting parameters [28]. The correlation obtained by the training ANN model are better than the one obtained by the regression analysis model. The results show that the tool–chip interface temperature equation derived from regression analysis and ANN model can be used for prediction.

The infrared method gives a relatively good indication of the measured temperature. The chip's top temperature was measured using the infrared camera [29] and [30]. The relationship between the inputs and corresponding outputs is established from the measured data. Then, modeling of the measured data was performed using the response surface methodology, various types of ANN and hybrid, neuro-fuzzy system. The models were tested and the results show good coincidence with the measured data. Finally, the system for the adaptive control of the cutting temperature is presented.

Modeling and control of the main process indicators can be very useful, and it can help machine shops to machine under optimum conditions, and to reduce the production costs, which is the main goal of any manufacturing production.

As shown, soft computing techniques offer a large field of implementation in the manufacturing process. In the following sections, two examples of using soft computing techniques for process parameters determination are presented.

III. THE SYSTEM FOR PREDICTING CUTTING PARAMETERS

The intelligent system for predicting cutting parameters in turning is proposed in this section. At first, experimental investigations were performed, in order to get relevant data about the metal cutting process parameters. Component relations and information flow of the material handling system is shown at Fig. 1 [31].

Cutting temperature and cutting forces have a big, mainly

negative influence on the metal cutting process parameters. They also depend on a large number of factors, while the quality of the machined surface is one of the main qualitative identifiers of the mentioned process. The pre-processing phase includes the following: experimental data acquisition, representation and analysis of data about cutting temperature, cutting forces, as well as the quality of the machined surface, all depending on the input parameters which are: cutting speed, feed rate and depth of cut. Collected data were systematized and analyzed in the appropriate way. Correlations between input and corresponding output parameters were established, as well as trends of the parameters changing.

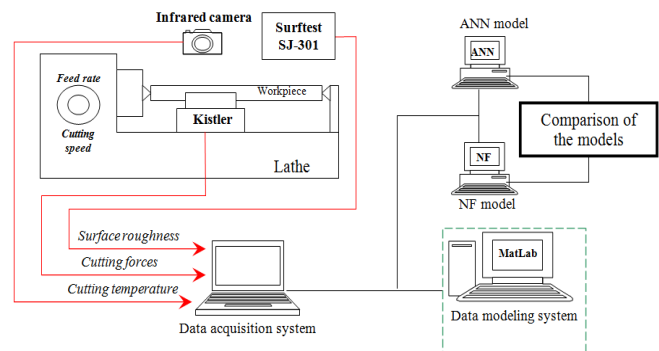

Fig. 1 Information flow of the material handling system

In the next phase, data were modeled using the following methods of soft computing: artificial neural networks and adaptive neuro-fuzzy systems. ANNs models for predicting cutting temperature, cutting force and surface roughness are: ANNTEMP, ANNFORCE and ANNSURF, whereas corresponding neuro-fuzzy models are: NFTEMP, NFFORCE and NFSURF. After that, the comparative analysis of the obtained models were made, which had to provide an answer to which model should be used for this kind of problems. The maximum, as well as the average mean errors were calculated for every single case, and their values are given in Table I. From the analysis of these values, it can be concluded that, a hybrid, adaptive neuro-fuzzy system gives a bit more accurate values than artificial neural networks. In almost all situations (accept the maximum error in cutting force prediction) the error was minor in case of using the hybrid, adaptive neuro-fuzzy system.

TABLE I
 MAXIMUM AND MEAN ERRORS OF THE USED SYSTEMS

Model	Max. error [%]	Mean error [%]
<i>Cutting temperature</i>		
ANNTEMP	14,057	3,496
NFTEMP	8,773	3,396
<i>Cutting force</i>		
ANNFORCE	13,637	4,388
NFFORCE	17,843	3,876
<i>Arithmetic mean deviation</i>		
ANNSURF	12,628	6,932
NFSURF	11,321	6,310

In the metal cutting process, the exact time of tool changing is a very important question. The main constraint factors which occur during analysis of that problem are related to, firstly, providing the required quality of the machined surface and, secondly, the maximum exploitation of the used tool. So, the system which could successfully solve this problem must take into consideration all of the relevant factors, as well as their overall influence on the current state of the tool. Systems for cutting temperature, cutting force and surface quality prediction, based on the artificial neural networks and adaptive neuro-fuzzy technologies represent sub-systems of this, global system. Fig. 2 shows two possible variant solutions of this problem.

Since adaptive neuro-fuzzy systems showed better characteristics, they were adopted for sub-systems of the main system. The first variant represent the “parallel” connection of these sub-systems where input parameters of all the models are cutting regimes, while output values, together with the other relevant parameters, go into the artificial intelligence based system for prediction of the cutting tool state. In the second variant, the “serial” connection between defined sub-systems is presented, i.e. outputs from the foregoing subsystem, together with the cutting regimes, represent inputs in the subsequent sub-system (or global system). The output from the last sub-system, together with the other relevant factors, goes into the global (identical to the previous case) system, which gives prediction of the cutting tool state.

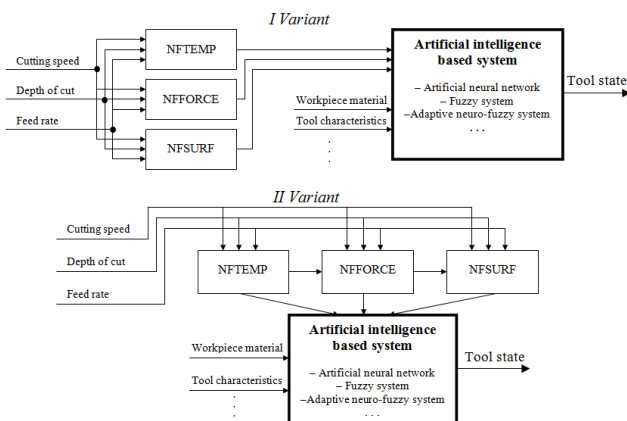

Fig. 2 Variant solutions of the tool state prediction system

Principally, the second variant is a little bit more complex, but the accuracy of such a system would be better because of more precise definition of the input parameters of each sub-system. The global system can be based on the artificial neural networks, fuzzy logic, adaptive neuro-fuzzy technologies, or some other artificial intelligence based system. The output from this system is the evaluation of the cutting tool state (sharp or worn). This signal could be a significant and objective cutting tool state identifier, and could be further used for the projection of intelligent manufacturing.

The main goals are: the qualitative analysis of the metal cutting process, identifying and resolving the most frequent

problems, and finally improving the manufacturing productivity.

IV. THE SYSTEM FOR PREDICTING PLASMA CUTTING PARAMETERS

The plasma cutting process belongs to the group of highly utilized processes in the industry. The goal of predicting parameters is to determine the values of cut quality parameters for a certain combination of input process parameters. The process is shown in Fig. 3.

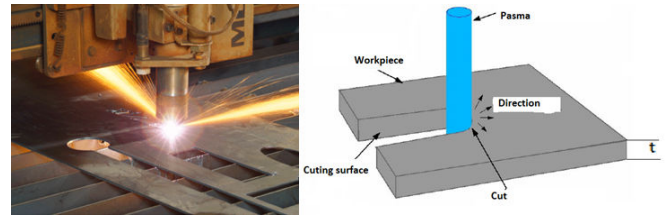

Fig. 3 Plasma cutting process

Experimental research was conducted using a CNC machine for plasma cutting. Stainless steel, mark X10CrNiMn-16-10-2 (EN 10025), was used. Three different values of electric current could be used to cut this material: 45 A, 80 A, and 130 A. Straight line cuts were made, and the material was cut in five different thicknesses: 4, 6, 8, 12, and 15 mm. For each thickness, cutting was performed using all available values of electric current (I), where, according to the thickness (s) and selected electric current, and in line with the manufacturer’s recommendations, cutting speeds (v) were chosen and varied. Fig. 4 shows the measuring samples. 150 measurements were performed [32].

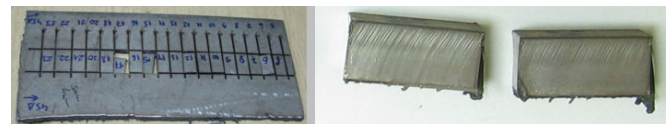

Fig. 4 Experimental samples

Measuring of basic cut quality elements was performed for each sample, upon which output plasma cutting process parameters were obtained: width of cut, the roughness of the cut, and the deviation angle of the cut.

Applying the regression analysis yielded three regression equations for each individual process output value:

$$\text{Width of cut} \\ s_r = 1,2725 \cdot I^{0,043} \cdot v^{-0,111} \cdot s^{0,149} \quad (1)$$

$$\text{The roughness of the cut} \\ R_z = 43,7264 \cdot I^{-0,579} \cdot v^{0,11} \cdot s^{-0,271} \quad (2)$$

$$\text{The deviation angle of the cut} \\ \beta = 1,4313 \cdot I^{-0,535} \cdot v^{0,529} \cdot s^{1,719} \quad (3)$$

Using the artificial neural networks, three trained networks were obtained with one input layer with 3 neurons (electric

power, cutting speed, and material thickness) and one output layer with one output value for each chosen output value whose prediction was performed. The following trained neural networks were obtained for: width of cut prediction (ANN-Sr), the roughness of the cut prediction (ANN-R_Z), and the deviation angle of the cut prediction (ANN-β). Figures 5, 6, and 7 show respective comparison of experimental results, data obtained through linear regression equations, and data obtained through simulation of a previously trained network. These data are presented for a set of 17 different combinations.

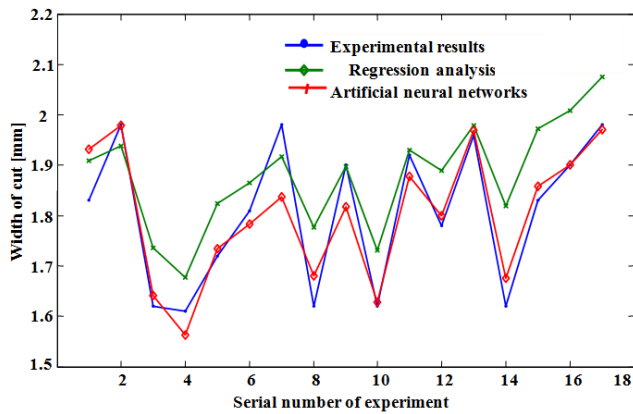
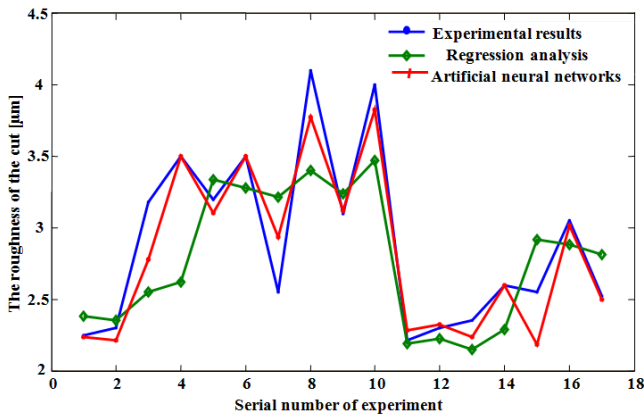
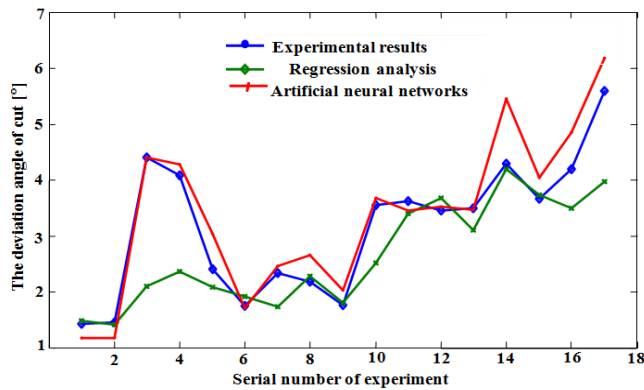

Fig. 5 Prediction of the width of cut



(a)



(b)

Fig. 6 Prediction of the deviation angle of the cut

Based on the diagrams, it can be concluded that artificial neural networks give a very good model for predicting process parameters.

V. CONCLUSION

Soft computing techniques are artificial intelligence based techniques and they are very powerful tool for solving extremely complex, nonlinear processes. A review of their use in various fields of manufacturing process is presented in the first part of this paper.

Conventional metal cutting and plasma cutting are complex processes depending on many input parameters and their intermediate correlations. Precise mathematical modeling of these processes is almost impossible. Relationship among the process input parameters and corresponding outputs was established from the measured data. Modeling of the measured data was performed using the response surface methodology, various types of artificial neural networks and hybrid, neuro-fuzzy system. All models were trained and tested. In general, the results of the modeling are in good agreement with the experimentally obtained data.

Finally, the global system for predicting the state of the cutting tool was proposed (with the sub-systems such as: sub-system for cutting temperature, sub-system for cutting force and sub-system for surface roughness prediction), in case of the conventional metal cutting process.

ACKNOWLEDGMENT

Research work presented in the paper is funded by the Serbian Ministry of Science within the projects III41017 and TR34005.

REFERENCES

- [1] I. Mukherjee, P. K. Ray, "A review of optimization techniques in metal cutting processes," *Computers & Industrial Engineering*, vol. 50, pp. 15-34, 2006.
- [2] V. Venugopal, T. T. Narendran, "Neural network model for design retrieval in manufacturing systems," *Computers in Industry*, vol. 20, pp. 11-23, 1992.
- [3] S. V. Kamarthi, S. T. Kumara, F. T. S. Yu and I. Ham, "Neural networks and their applications in component design data retrieval," *Journal of Intelligent Manufacturing*, vol. 1, no. 2, pp. 125-140, 1990.
- [4] T. W. Simpson, J. D. Peplinski, P. N. Koch and J. K. Allen, "Metamodels for computer-based engineering design: survey and recommendations," *Engineering with Computers*, vol. 17, pp. 129-150, 2001.
- [5] W. L. Chan, M. W. Fu and J. Lu, "An integrated FEM and ANN methodology for metal-formed product design," *Engineering Applications of Artificial Intelligence*, vol. 21, no. 8, pp. 1170-1181, 2008.
- [6] S. H. Yeo, M. W. Mak and S. A. P. Balon, "Analysis of decision-making methodologies for desirability score of conceptual design," *Journal of Engineering Design*, vol. 15, no. 2, pp. 195-208, 2004.
- [7] J. H. Jahnke, "Cognitive support in software reengineering based on generic fuzzy reasoning nets," *Fuzzy Sets and Systems*, vol. 145, pp. 3-27, 2004.
- [8] S. T. Kumara, S. V. Kamarthi, "Function-to-structure transformation in conceptual design: An associative memory based paradigm," *Journal of Intelligent Manufacturing*, vol. 2, no. 5, pp. 281-292, 1991.

- [9] K. Osakada, G. B. Yang, "Neural networks for process planning of cold forging," *International Journal of Machine Tools and Manufacture*, vol. 31, no. 4, pp. 577-587, 1991.
- [10] J. L. Hwang, M. R. Henderson, "Applying the perceptron to three-dimensional feature recognition," *Journal of Design and Manufacturing*, vol. 2, no. 4, pp. 187-198, 1992.
- [11] L. Ding, J. Matthews, "A contemporary study into the application of neural network techniques employed to automate CAD/CAM integration for die manufacture," *Computers & Industrial Engineering*, vol. 57, no. 4, pp. 1457-1471, 2009.
- [12] M. Santochi, G. Dini, "Use of neural networks in automated selection of technological parameters of cutting tools," *Computer Integrated Manufacturing Systems*, vol. 9, no. 3, pp. 137-148, 1996.
- [13] M. G. Marchetta, R. Q. Forradellas, "An artificial intelligence planning approach to manufacturing feature recognition," *Computer-Aided Design*, vol. 42, no. 3, pp. 248-256, 2010.
- [14] Y. P. S. Foo, Y. Takefuji, "Integer linear programming neural networks for job-shop scheduling," in *Proc. 1988 Int. IEEE Conf. Neural Networks*, vol. 2, 1988, pp.341-348
- [15] J. C. Vidal, M. Mucientes, A. Bugarin and M. Lama, "Machine scheduling in custom furniture industry through neuro-evolutionary hybridization," *Applied Soft Computing*, vol. 11, no. 2, pp. 1600-1613, 2011.
- [16] T. Karim, B. Reda and H. Georges, "Multi-objective supervisory flow control based on fuzzy interval arithmetic: Application for scheduling of manufacturing systems," *Modelling Practice and Theory*, vol. 19, no. 5, pp. 1371-1383, 2011.
- [17] Y.-R. Shiue, R.-S. Guh, "Study of SOM-based intelligent multi-controller for real-time scheduling," *Applied Soft Computing*, to be published.
- [18] J. M. Cadenas, M. C. Garrido and E. Muñoz, "Facing dynamic optimization using a cooperative metaheuristic configured via fuzzy logic and SVMs," *Applied Soft Computing*, to be published.
- [19] W.-C. Chen, G.-L. Fu, P.-H. Tai and W.-J. Deng, "Process parameter optimization for MIMO plastic injection molding via soft computing," *Expert Systems with Applications*, vol. 36, no. 2, pp. 1114-1122, 2009.
- [20] N. Thitipong, N. V. Afzulpurkar, "Optimization of tile manufacturing process using particle swarm optimization," *Swarm and Evolutionary Computation*, vol. 1, no. 2, pp. 97-109, 2011.
- [21] G. K. M. Rao, G. Rangajanardhaa, D. H. Rao, M. S. Rao, "Development of hybrid model and optimization of surface roughness in electric discharge machining using artificial neural networks and genetic algorithm," *Journal of Materials Processing Technology*, vol. 209, no. 3, pp. 1512-1520, 2009.
- [22] H. C. W. Lau, E. N. M. Cheng, C. K. M. Lee and G. T. S. Ho, "A fuzzy logic approach to forecast energy consumption change in a manufacturing system," *Expert Systems with Applications*, vol. 34, no. 3, pp. 1813-1824, 2008.
- [23] M. Salehi, A. Bahreinejad and I. Nakhai, "On-line analysis of out-of-control signals in multivariate manufacturing processes using a hybrid learning-based model," *Neurocomputing*, vol. 74, no. 12-13, pp. 2083-2095, 2011.
- [24] S. S. Rangwala and D. A. Dornfeld, "Learning and optimization of machining operations using computing abilities of neural networks," *IEEE Transactions on System, Man, and Cybernetics*, vol. 19, no. 2, pp. 299-314, 1989.
- [25] Y. S. Tarn, T. C. Wang, W. N. Chen and B. Y. Lee, "The use of neural networks in predicting turning forces," *Journal of Materials Processing Technology*, vol. 47, pp. 273-289, 1995.
- [26] J. Yu, L. Xi and X. Zhou, "Identifying source(s) of out-of-control signals in multivariate manufacturing processes using selective neural network ensemble," *Engineering Applications of Artificial Intelligence*, vol. 22, no. 1, pp. 141-152, 2009.
- [27] M. T. Hayajneh, A. M. Hassan and A. T. Mayyas, "Artificial neural network modeling of the drilling process of self-lubricated aluminum/alumina/graphite hybrid composites synthesized by powder metallurgy technique," *Journal of Alloys and Compounds*, vol. 478, no. 1-2, pp. 559-565, 2009.
- [28] I. Korkut, A. Acir and M. Boy, "Application of regression and artificial neural network analysis in modelling of tool-chip interface temperature in machining," *Expert Systems with Applications*, vol. 38, no. 9, pp. 11651-11656, 2011.
- [29] D. Tanikić, M. Manić, G. Devedžić, Z. Stević, "Modelling Metal Cutting Parameters Using Intelligent Techniques," *Strojniški vestnik - Journal of Mechanical Engineering*, vol. 56, no. 1, pp. 52-62, 2010.
- [30] D. Tanikić, M. Manić, G. Devedžić, Ž. Čojbašić, "Modelling of the Temperature in the Chip-Forming Zone Using Artificial Intelligence Techniques," *Neural Network World*, vol. 20, no. 2, pp. 171-187, 2010.
- [31] D. Tanikić, "Modeling of the correlations among metal cutting process parameters using the adaptive neuro-fuzzy systems," Phd thesis, Mechanical Engineering Faculty of the University of Niš, 2009, (in serbian).
- [32] D. Lazarević, "Modeling correlation between the parameters of the plasma cutting and analysis of heat balance using the method of artificial intelligence," Phd thesis, Mechanical Engineering Faculty of the University of Niš, Serbia, 2009, (in serbian).