

Computational Conjugate Heat Transfer Analysis of HP Stage Turbine Blade Cooling: Effect of Turbulator Geometry in Helicoidal Cooling Duct

Chandrakant R Kini, Satish Shenoy B, and Yagnesh Sharma N.

Abstract—In a bid to improve turbine entry temperature for maximizing the thermal efficiency of the HP stage gas turbine blade, an attempt is made in this paper to compare the performance of helicoidal ducted blade cooling with turbulator of different geometric proportion. It is found from analysis that there is significant improvement in cooling characteristics for turbine blade with turbulator geometry having larger e/D ratio. Also it is found from analysis, performance is vastly improved for greater thickness of turbulator geometry.

Keywords—Conjugate heat transfer, turbine blade cooling, helicoidal cooling duct, turbulator.

I. INTRODUCTION

GAS Turbines are widely used in aircraft propulsion and electric power generation. The gas turbine is a power plant, which produces a lot of energy for its size and weight. Its compactness, low weight and multiple fuel application make it a natural power plant for many applications. Thermal efficiency and power output of gas turbines increase with increasing turbine entry temperature (TET). From Brayton cycle it is known that the increase in pressure ratio increases the gas turbine thermal efficiency accompanied with increase in turbine firing temperature [7]. The increase in pressure ratio increases the overall efficiency at a given temperature. However increasing the pressure ratio beyond a certain value at any given firing temperature can actually result in lowering the overall cycle efficiency [7].

As the TET level increases, the heat transferred to the blades in the turbine also increases. The level and variation in the temperature within the blade material (which causes thermal stresses) must be limited to achieve reasonable durability goals. [4, 5]

Chandrakant R Kini is with Department of Mechanical and Manufacturing Engineering, MIT, Manipal University, Manipal, India.

Satish Shenoy B is with Department of Aeronautical and Automobile Engineering, MIT, Manipal University, Manipal, Karnataka State, India.

Yagnesh Sharma N is with Department of Mechanical and Manufacturing Engineering MIT, Manipal University, Manipal, Karnataka State, India (e-mail: nysharma@hotmail.com)

Also the temperatures are far above the permissible metal temperature due to which there is a need to cool the blades to operate without failure [6]. Therefore, along with high temperature resistant material development, a sophisticated cooling scheme must be developed for HP stage turbine blade for continuous and safe operation with high performance [6]. Several research works are being carried out to address the above problems.

II. THEORETICAL FORMULATION AND METHOD OF SOLUTION

The objective of the analysis is to study the effect of turbulator geometry in helicoidal cooling ducts on gas turbine blade cooling by varying the geometric proportions. The following assumptions are made.

1. The computational domain is assumed to be made of solid-liquid interface with conjugate heat transfer.
2. Steady incompressible flow for the fluid.
3. Material properties and other thermophysical properties are assumed to be constant with respect to temperature.
4. Flow is assumed to be turbulent with fully developed conditions.
5. Solution is marched in time and steady state is assumed to be obtained after all residuals are brought to prescribed constant values.

A. Numerical Model

The commercial CFD software FLUENT (version 6.3.26) from Fluent, Inc. is employed for analysis. The simulation uses the segregated solver, which employs an implicit pressure-correction scheme. The SIMPLE algorithm is used to couple pressure and velocity. First order upwind scheme is selected for spatial discretization of the Reynolds Averaged Navier Stokes (RANS) equations as well as energy and turbulence equations [9, 10]. Converged results are obtained after the residuals were found to be less than the specified values. A converged result renders an energy residual of 10^{-6} , and momentum and turbulence kinetic energy residuals being 10^{-5} [10].

Flow equations: Equations 1 to 6 are presented in cartesian tensor notation as follows:

Mean flow equations:

Continuity:

$$\frac{\partial}{\partial x_i}(\rho U_i) = 0 \quad (1)$$

Momentum Transport:

$$\frac{\partial}{\partial x_j}(\rho U_i U_j) = \frac{\partial P}{\partial x_i} + \frac{\partial}{\partial x_j} \left[\mu \left(\frac{\partial U_i}{\partial x_j} + \frac{\partial U_j}{\partial x_i} \right) - \overline{\rho u_i u_j} \right] \quad (2)$$

Enthalpy:

$$\frac{\partial}{\partial x_j}(\rho U_i T) = \frac{\partial}{\partial x_j} \left[\frac{\mu}{Pr} \frac{\partial T}{\partial x_j} - \overline{\rho u_i t} \right] \quad (3)$$

Turbulence modeling equations:

Zonal k-ε model: This consists of the high-Re k-ε in the fully turbulent core:

$$\frac{\partial}{\partial x_j}(\rho U_j k) = \frac{\partial}{\partial x_j} \left[\left(\mu + \frac{\mu_t}{\sigma_k} \right) \frac{\partial k}{\partial x_j} \right] + P_k - \rho \epsilon \quad (4)$$

$$P_k = -\overline{\rho u_i u_j} \left(\frac{\partial U_i}{\partial x_j} \right) \quad (5)$$

$$\frac{\partial}{\partial x_j}(\rho U_j \epsilon) = \frac{\partial}{\partial x_j} \left[\left(\mu + \frac{\mu_t}{\sigma_\epsilon} \right) \frac{\partial \epsilon}{\partial x_j} \right] + c_{\epsilon 1} \frac{\epsilon}{k} P_k - \rho c_{\epsilon 2} \frac{\epsilon^2}{k} \quad (6)$$

B. Blade Configuration for the Analysis

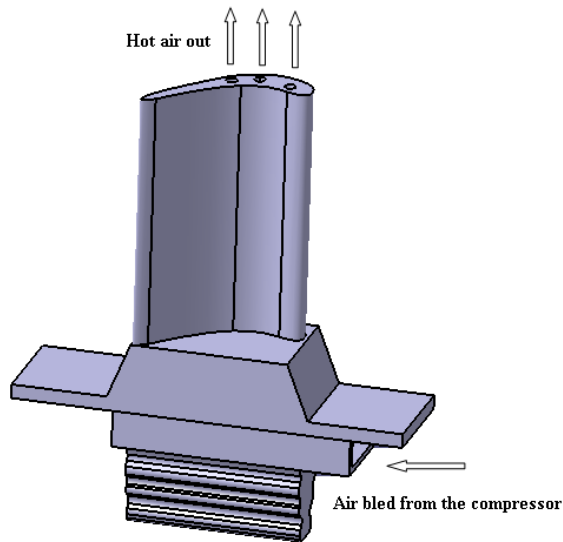

Fig. 1 Schematic of turbine blade with cooling ducts

While the configuration of the internal cooling ducts in real gas turbine airfoil can be highly complicated, in the present analysis, a simplified geometric model with different ducts of varying geometry is being tried for effective cooling considerations as shown in Fig. 1. In general, the coolant air enters the cooling ducts from the blade root, flows through entire length of ducts and finally leaves from blade tip. The complete cooling process is internal convective cooling. The

cooling ducts having through circular ducts with hole radius of 2mm and helicoidal ducts of pitch length 6 mm with hole radius of 2mm are being considered for the analysis.

C. Boundary Conditions for the Computational Domain

The main boundary conditions utilized both for gas turbine blade and cooling ducts are presented here. The parameters are associated with practical gas turbine operating conditions, corresponding to HP turbine stage featured with high temperature and velocity. The main flow has a convective boundary condition with free stream temperature of hot gas as 1561 K and convective heat transfer coefficient of hot gas as 2028 W/m²K [9]. The coolant jet flow has an air temperature of 644 K [9] and mass flow rate of 90 kg/hr. These settings are selected from available literature with a view to get a realistic representation of typical gas turbine operating conditions. The properties of air at 644 K (refer Table I) and for the turbine blade material (refer Table II) are as follows [10, 11].

TABLE I
THERMO PHYSICAL PROPERTIES OF AIR AT 644 K

Properties	Units
Density	0.54 kg/m ³
Specific heat	1.06 kJ/kg K
Thermal conductivity	0.05 W/ m K
Kinematic Viscosity	59 × 10 ⁻⁶ m ² /s

TABLE II
THERMAL PROPERTIES OF BLADE MATERIAL

Properties	Units
Density	8010 kg/m ³
Specific heat	419 J/kg °C
Thermal conductivity	10.89 W/m °C

D. Numerical grid, Meshing and Simulation Procedure

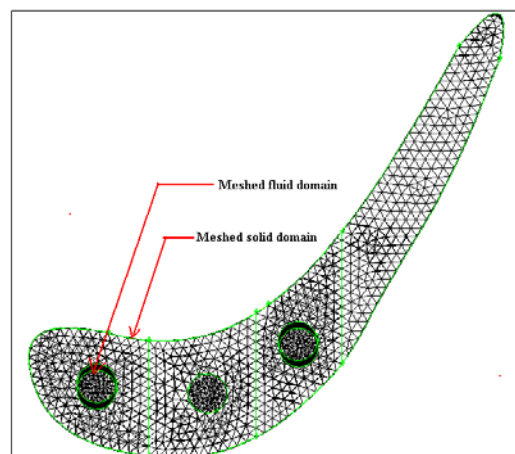

Fig. 2 Gas turbine blade modeled in CATIA and meshed in GAMBIT

The information for geometric model for HP stage gas turbine was derived directly by measuring the coordinates of the blade profile of a thermally damaged turbine blade using

Coordinate Measuring Machine available in Author's Institute. Gas turbine blades along with different cooling ducts configurations were modeled using the software CATIA (V5 R14) [13], which is industry bench marked standard software for modeling. To conduct numerical simulation, the computational domain as shown in Fig. 2, is meshed with control volumes built around each grid using GAMBIT (V 2.4.6) [12], which is the preprocessor for FLUENT (V 6.3.26) [12]. The mesh for blade simulation is an unstructured type consisting of 19, 30, 679 tetrahedral cells. But refined tetrahedral mesh was employed for cooling ducts as dimensions were very small, so as to extract good accuracy. The grid independence test was performed to the quality of mesh for solution accuracy. The influence of further refinement did not change the result by more than 1.25 % which is taken here as appropriate mesh quality for computation as shown in Fig. 3.

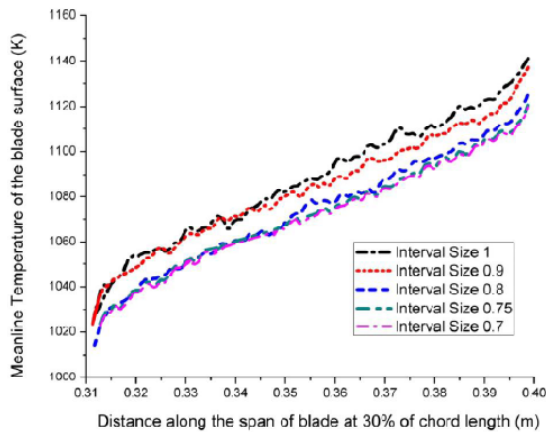

Fig. 3 Results of grid independence test

III. RESULTS AND DISCUSSIONS

The results of the thermal analysis in each case corresponding to parametric considerations of the geometry of the cooling duct are detailed below. The results analysis follows the cooling capabilities of helicoidal duct of various pitch lengths viz-a-viz the circular duct of same diameter.

The non-dimensional temperature θ is defined as $\theta = \frac{T_{\infty} - T_L}{T_{\infty} - T_0}$ where T_{∞} is hot gas temperature surrounding the

blade profile in a convective ambience, T_L is the temperature along the span length of the blade and T_0 is temperature of the cooling air admitted to the cooling duct at the blade root. Similarly the non-dimensional span length δ is defined as $\delta = \frac{L}{S}$ where L is the distance along the span length which the

blade temperature is measured and S is overall span length [1]. Kini et. al in earlier research work [1,2,3] found that for various geometric configuration of diameter of cooling duct and pitch length, a diameter corresponding to 4mm and pitch length of 6 mm helicoidal cooling duct provides a significant improvement in turbine blade cooling. In consideration of this aspect the present paper extends the work to study the

additional effect of turbulator with improved cooling duct geometry.

A. Blade Cooling with Helicoidal Duct of Circular Cross Section 2mm Radius with Pitch Length of 6 mm Having Turbulators

Turbulators are very vital in the process of heat dissipation. Generally a turbulators is designed such as to abruptly change the flow at regular intervals. It is well know from convective heat transfer concepts that the turbulators tend to augment surface Nusselt number of the flow. Though from view point of pressure drop this may appear as dissipative loss of fluid energy. Nusselt number is a direct function of convective heat transfer coefficient (film coefficient of heat transfer). Based on convective heat transfer correlations for the forced convection heat transfer that occurs inside the cooling helicoidal duct it is possible to deduce conclusive proof of better cooling of turbine blade.

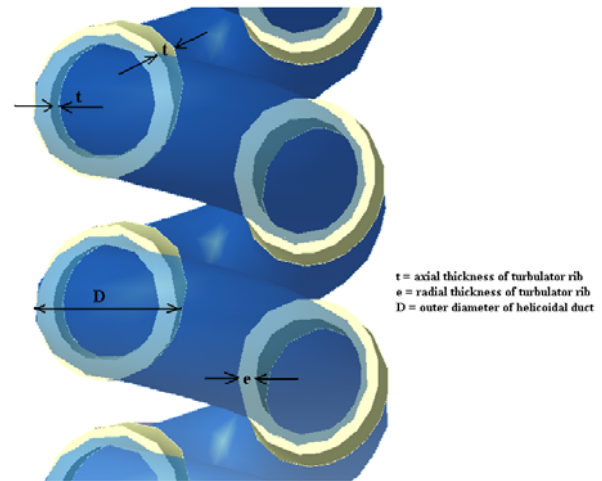

Fig. 4 Geometric model of cooling ducts having rib turbulators, showing the rib geometry

Fig. 4 shows the helicoidal cooling duct (shown in translucent blue colour) with rib turbulators (shown in light yellow colour) placed at half pitch distance between one another. The rib geometry is described as follows.

t = axial thickness of turbulator rib (measured along the helicoidal path)

e = radial thickness of turbulator rib

D = outer diameter of helicoidal duct

e/D is non dimensional ratio chosen as parametric variable for different configurations of rib geometries. The parametric values of e/D chosen for analysis are a) $e/D = 0.04$ b) $e/D = 0.06$ c) $e/D = 0.08$. In addition the axial thickness of turbulator rib is also parametrically changed with 0.5 mm and 0.75 mm thickness.

In respect of this, three different cases with varied turbulator geometry are discussed below.

Case 1: Circular rib turbulators of thickness 0.5mm, 0.75 mm and e/D ratio of 0.04

Fig. 5 shows surface Nusselt number along the axial thickness of the turbulator along the axis of cooling duct. It is clearly observed that turbulators of 0.5 mm and 0.75 mm

thickness with e/D ratio of 0.04 shows a significant improvement in Nusselt number of near surface of the cooling duct. It is also evident from the plot that there is periodic variation in the surface Nusselt number corresponding to different thickness of the turbulators. This periodic variation arises due to placement of turbulators at regular periodic intervals as shown in geometric domain with rib turbulators in place (Fig. 4). The physical explanation for utility of turbulators will be clear after a careful appraisal of Nusselt number distribution over the blade. The turbulators are useful in effecting sudden change in flow field there by producing a sustainable turbulence of small intensity.

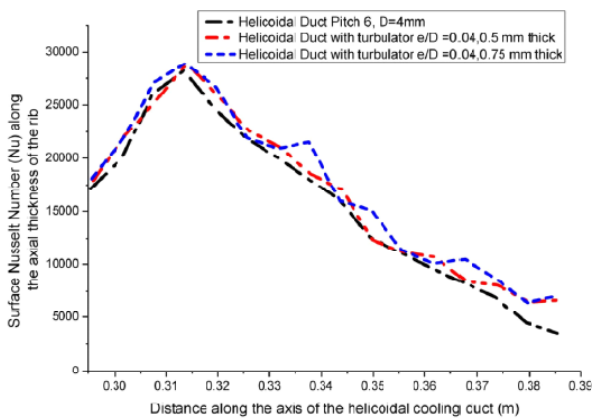

Fig. 5 Nusselt number variation along the axis of the cooling duct

There is trade off in selecting a particular geometry of rib turbulator. For smaller geometries, it is observed that there will be a minimum pressure loss and hence a lower loss of flow energy but heat transfer due to turbulence may not be higher. Corollary of this leads to turbulators having higher geometry where the pressure loss could be higher but due to better turbulence the heat transfer could be better. The contour plot of pressure, average velocity and average temperature at near region of the turbulators is shown in figures 6, 7, 8, 9, 10 and 11.

For a given e/D ratio of rib geometry but with different axial thickness of turbulators (0.5 mm and 0.75 mm) as shown in Fig. 5, it can be easily be appraised that turbulators with 0.75 mm thickness shows a marked increase in surface Nusselt number variation when compared to turbulator of 0.5 mm thickness. The increased Nusselt number of flow is indicative of higher convective heat transfer and hence it is certain that by providing turbulators it is possible to increase the heat dissipation from the turbine blade.

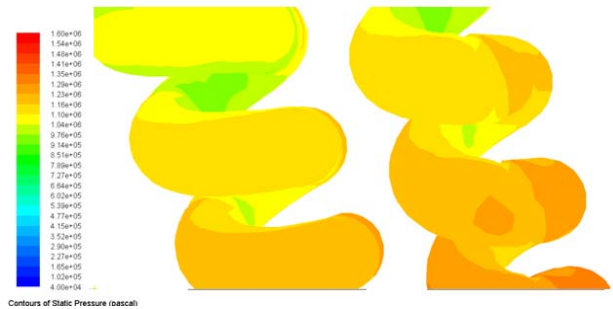

Fig.6 Contours of static pressure for cooling ducts having turbulators of $e/D = 0.04$ and 0.5mm rib thickness

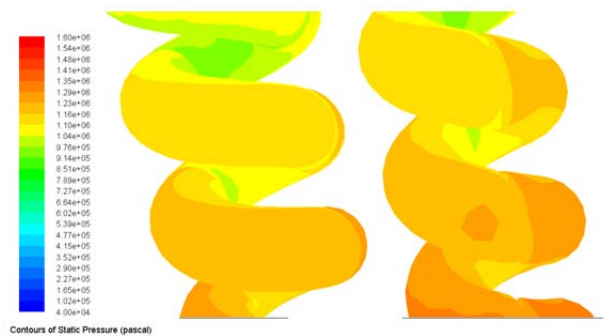

Fig. 7 Contours of static pressure for cooling ducts having turbulators of $e/D = 0.04$ and 0.75mm rib thickness

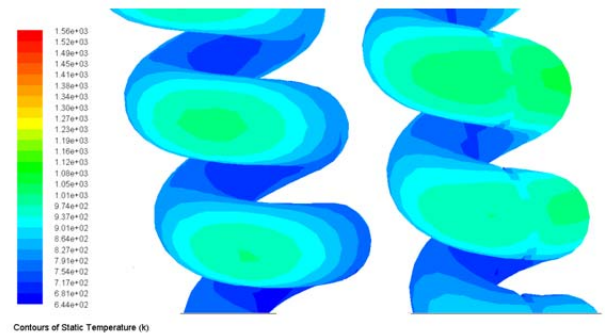

Fig. 8 Contours of static temperature for cooling ducts having turbulators of $e/D = 0.04$ and 0.5mm rib thickness

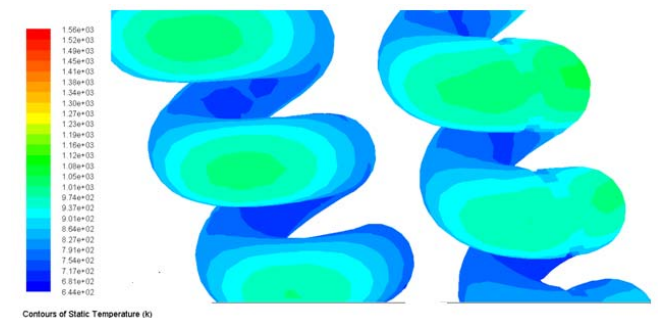

Fig. 9 Contours of static temperature for cooling ducts having turbulators of $e/D = 0.04$ and 0.75mm rib thickness

This fact is also established in Figs. 6 and 7 where pressure contours clearly indicate a higher pressure drop for larger axial thickness turbulator when compared to smaller axial thickness turbulator of 0.5 mm thickness. Thus it is important to optimize the turbulator geometry for effective cooling purposes.

Figs. 8 and 9 show the contours of temperature for the two cases of turbulators thicknesses of 0.5 mm and 0.75 mm. As already explained earlier turbulator with 0.75 thickness shows higher thermal energy while absorbing heat from the hot blade surface

Figs. 10 and 11 depict velocity vectors in the vicinity of turbulators. It is observed that the velocity vectors showed a marked increase while passing through constricted turbulators thereby increasing convectivity of heat transfer to the cooling duct. The purpose of the turbulator is to create miniature pools of vortices which effectively dissipate heat from underneath to the blade surface.

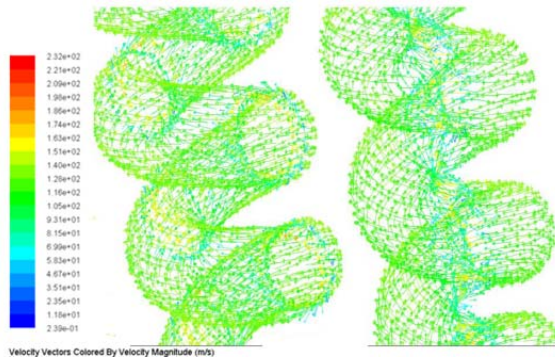

Fig. 10 Velocity vectors for cooling ducts having turbulators of $e/D = 0.04$ and 0.5mm rib thickness



Fig. 11 Velocity vectors for cooling ducts having turbulators of $e/D = 0.04$ and 0.75mm rib thickness

Case 2: Circular Rib Turbulators of Thickness 0.5mm, 0.75 mm and e/D Ratio of 0.06

Fig. 12 shows the result pertaining to e/D ratio of 0.06 and it is observed that for e/D ratio of 0.06, turbulator thickness of 0.75mm there is marginal higher surface Nusselt number compared to e/D ratio of 0.06 and turbulator thickness of 0.5mm. The increased Nusselt number manifests itself as increased convective heat transfer coefficient. Therefore it is possible to conclude that a higher e/D ratio has better advantage compared to smaller e/D ratio of 0.04.

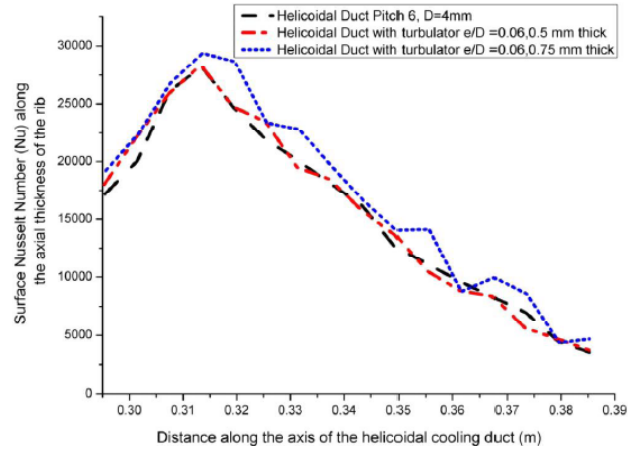

Fig. 12 Nusselt number variation along the span length of the cooling duct

With increased e/D ratio the flow path through the turbulator gets narrowed and hence exit velocity gets marginally increased compared to pressure, resulting in better cooling to the turbine blade. In general it can be seen that helicoidal cooling ducts with turbulators play a vital role in turbine blade cooling process.

In Figs. 13 and 14, the temperature contours show markedly lower levels more prominent near the turbulators than other places. The reason for decreased contour of temperature is definitely due to mechanism of turbulence at these significant places.

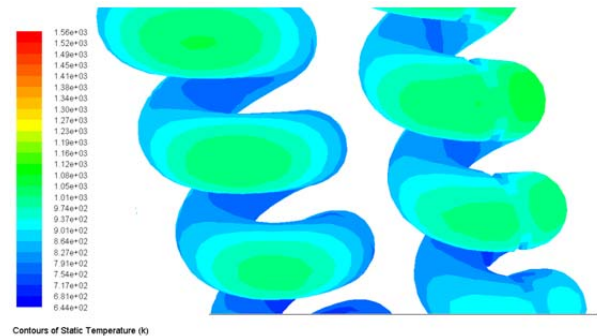

Fig. 13 Contours of static temperature for cooling ducts having turbulators of $e/D = 0.06$ and 0.5mm rib thickness

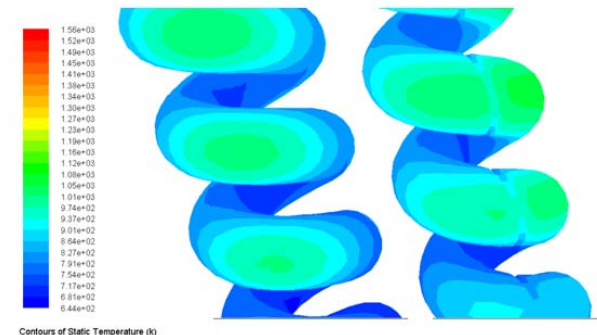

Fig. 14 Contours of static temperature for cooling ducts having turbulators of $e/D = 0.06$ and 0.75mm rib thickness

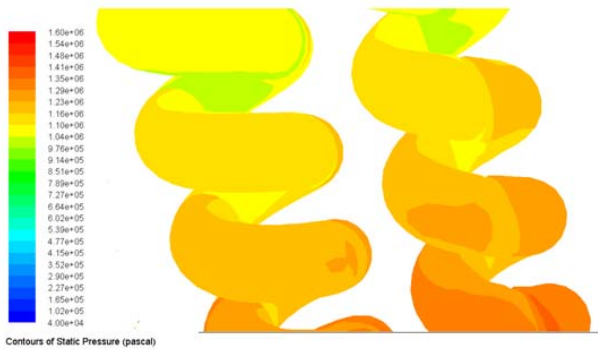

Fig. 15 Contours of static pressure for cooling ducts having turbulators of $e/D = 0.06$ and 0.5mm rib thickness

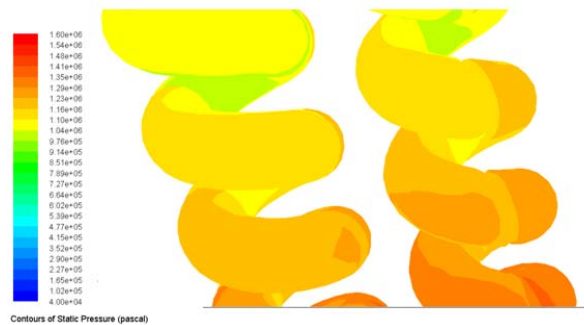

Fig. 16 Contours of static pressure for cooling ducts having turbulators of $e/D = 0.06$ and 0.75mm rib thickness

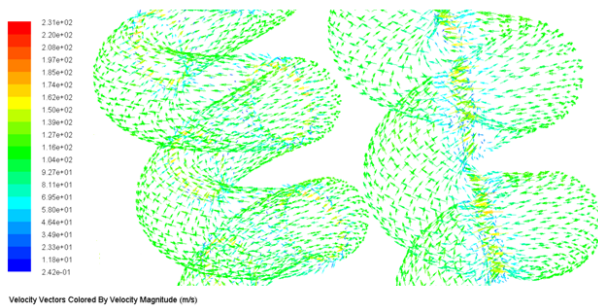

Fig. 17 Velocity vectors for cooling ducts having turbulators of $e/D = 0.06$ and 0.5mm rib thickness

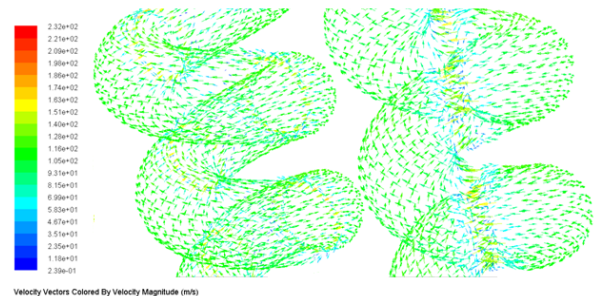

Fig. 18 Velocity vectors for cooling ducts having turbulators of $e/D = 0.06$ and 0.75mm rib thickness

There is also increased static pressure due to higher pressure drop in cooling passages with turbulators as shown in Fig. 15 and 16. It is quite clear from Fig. 17 and 18 that there

is more kinetic activity of cooled air near the regions of turbulators which is due to narrow passage through the turbulators.

The contour of static temperature, static pressure and velocity vectors reinforces the physical explanations given above reasonably establishes that for same e/D ratio of 0.06 and turbulator of 0.75mm thickness are definitely better than turbulators of 0.5mm thickness.

Case 3: Circular Rib Turbulators of Thickness 0.5mm, 0.75 mm and e/D Ratio of 0.08

Fig. 19 shows the results of surface Nusselt number variation for e/D ratio of 0.08 and turbulator thicknesses of 0.5mm and 0.75mm. From the trends of variations for helicoidal duct with turbulators, it is discernable that there is advantage for cooling duct with turbulators of e/D ratio of 0.08 and 0.75mm thickness. We find that the best performance among all the various cases considered is that of turbulators of e/D ratio of 0.08 and 0.75mm thickness.

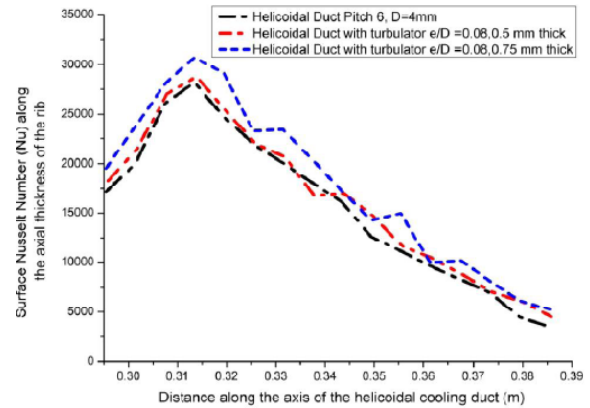

Fig. 19 Nusselt number variation along the span length of the cooling duct

Figs. 20, 21, 22, 23, 24 and 25 show contours of static temperature, static pressure and velocity vectors.

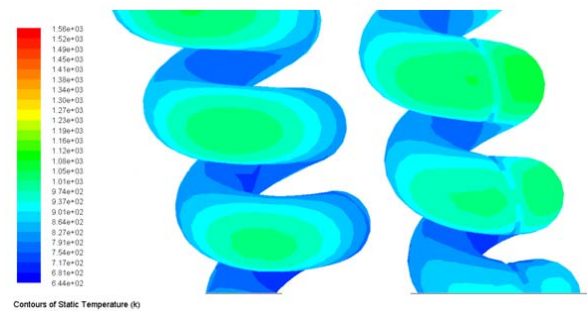

Fig. 20 Contours of Static Temperature for cooling ducts having turbulators of $e/D = 0.08$ and 0.5mm rib thickness

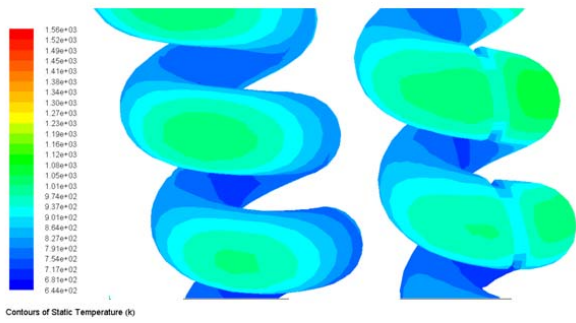

Fig. 21 Contours of Static Temperature for cooling ducts having turbulators of $e/D = 0.08$ and 0.75mm rib thickness

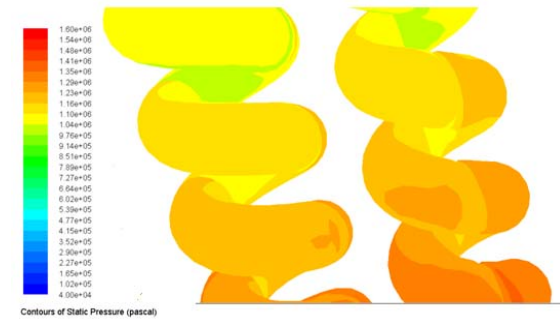

Fig. 22 Contours of Static Pressure for cooling ducts having turbulators of $e/D = 0.08$ and 0.5mm rib thickness

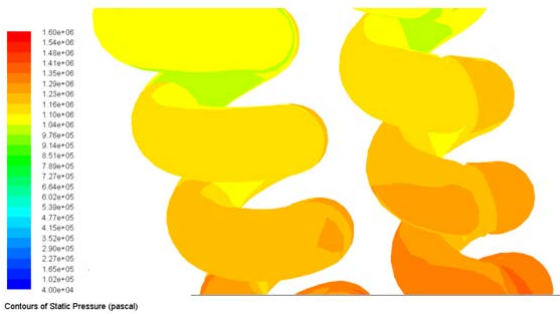

Fig. 23 Contours of Static Pressure for cooling ducts having turbulators of $e/D = 0.08$ and 0.75mm rib thickness

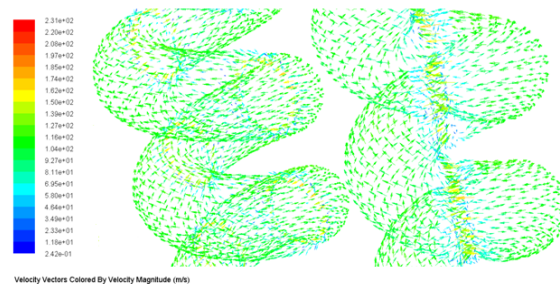

Fig. 24 Velocity vectors for cooling ducts having turbulators of $e/D = 0.08$ and 0.5mm rib thickness

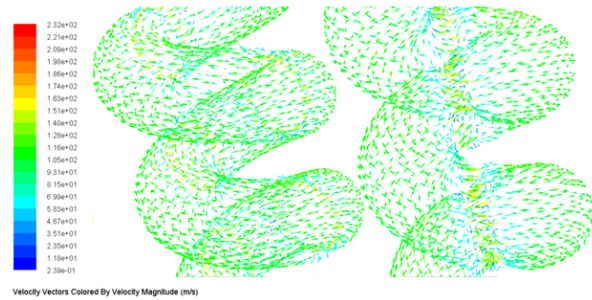

Fig. 25 Velocity vectors for cooling ducts having turbulators of $e/D = 0.08$ and 0.75mm rib thickness

IV. CONCLUSION

1. It is seen that an innovative helicoidal cooling passage, provides an augmented convective area for better heat dissipation.
2. The helicoidal path also acts as a turbulence generator resulting in extended heat dissipation rates due to the geometry.
3. The diameter and pitch length of the helicoidal duct plays a major role in optimizing the geometry of the helicoidal cooling passage.
4. It is also found from analysis that e/D ratio of 0.08 and turbulator thickness of 0.75 mm provides best geometric configuration with respect to better heat dissipation characteristics.

ACKNOWLEDGMENT

The Corresponding author wishes to gratefully acknowledge the financial support extended by the Manipal University, Manipal, India for sponsoring to this conference. The computational facilities were extended by Department of Mechanical Engineering, Manipal Institute of Technology, Manipal which is thankfully acknowledged.

REFERENCES

- [1] Chandrakant R Kini, Satish Shenoy B, and N Yagnesh Sharma (2012), "Numerical Analysis of Gas Turbine HP Stage Blade Cooling with New Cooling Duct Geometries", International Journal of Earth Sciences and Engineering, Volume 05 No 04 (02), pp. 1057-1062.
- [2] Chandrakant R Kini, Satish Shenoy B, and N Yagnesh Sharma (2012), "Numerical Analysis of Gas Turbine HP Stage Blade Cooling with New Cooling Duct Geometries", 2nd International Engineering Symposium - IES 2012, Kumamoto University, Japan, March 5-7.
- [3] Chandrakant R Kini, Satish Shenoy B, and N Yagnesh Sharma (2011), "A Computational Conjugate Thermal Analysis of HP Stage Turbine Blade Cooling with Innovative Cooling Passage Geometries", The 2011 International Conference of Mechanical Engineering, World Congress of Engineers, London, July 6-8.
- [4] Chyu, M.K., and Naturajan. V (1995); "Surface heat transfer from a three-pass blade cooling passage simulator", J. Heat Transfer, Vol. 117, pp. 650-656.
- [5] Dutta, S., Andrews, M.J., and Han, J.C., (1996); "Prediction of Turbulent Flow and Heat Transfer in Rotating Square and Rectangular Smooth Channels." International Gas Turbine & Aeroengine Congress & Exhibition, Birmingham, UK, June 10- 13, ASME Paper 96-GT-234
- [6] Han, J., Ekkad, S. (2001); "Recent Development in Turbine Blade Film Cooling", Int. J. of Rotating Machinery, Vol. 7, pp. 21-40.
- [7] Horlock, J.H. (2001); "Basic thermodynamics of turbine cools", J. Turbomachinery, Vol. 123, pp. 583-592.

- [8] Li, X., Wang, T. (2008); "Computational Analysis of Surface Curvature Effect on Mist Film-Cooling Performance", J. Heat Transfer, Vol. 130, pp. 121901-10.
- [9] Li, X., Wang, T. (2008); "Two-Phase Flow Simulation of Mist Film Cooling on Turbine Blades With Conjugate Internal Cooling", J. Heat Transfer, Vol. 130, pp. 102901-8
- [10] http://new.bibus.cz/pdf/Special_Metals/Nikl/prehled/nimonic-alloy_90_105.pdf
- [11] <http://www.engineeringtoolbox.com/air-properties>
- [12] Fluent 6.3, Fluent Inc., Cavendish Court Lebanon, NH, 03766, USA.
- [13] CATIA, Dassault Systems, 1994-2011.



Chandrakant R Kini is Research Scholar in the Department of Mechanical and Manufacturing Engineering, Manipal Institute of Technology, Manipal University, India. He has B.E in Mechanical Engineering and M. Tech in Thermal Engineering from NITK, Surathkal. Presently he is doing PhD. His area of research includes CFD analysis of Gas Turbine Blade cooling. (e-mail: chandrakini@gmail.com)



Satish Shenoy B is presently working as Associate Professor in Department of Aeronautical and Automobile Engineering, Manipal Institute of Technology, Manipal University, India. He has B.E in Mechanical Engineering and M. Tech in Production Engineering Systems Technology. He was awarded PhD degree for his Doctoral work in the area of "Performance evaluation of a single pad externally adjustable fluid film bearing" from Manipal University, Manipal. (e-mail: satish.shenoy@manipal.edu)



N. Yagnesh Sharma is corresponding Author and Professor in the Department of Mechanical & Manufacturing Engineering, obtained his B.E. degree in Mechanical Engineering from University of Mysore in 1978, and M.Tech. (Thermal Turbomachinery) from Indian Institute of Technology, Madras in 1981. He was awarded PhD degree for his doctoral work in the area of Gas Turbine Combustion from Indian Institute of Technology (Kharagpur) in 2002. He joined as a

Faculty in the Department of Mechanical Engineering of Manipal Institute of Technology, Manipal, in 1982. He was the Head of the Department of Mechanical & Manufacturing Engineering from 2008 to 2011. He has taken over charge from April 2012 as the Associate Director (Development). His research interests are in the area of Droplet combustion in gas turbine, Computational fluid dynamic studies on cooling of gas turbine blades, Numerical modeling and analysis of solar air and water heaters, Turbomachinery flows and Water Jet Cutting Process. He was recognised for his distinguished service of 25 years to MIT, by Manipal University in 2007. He is a Life Member of Institution of Engineers and ISTE. (e-mail: nysharma@hotmail.com)